

Clarke® Encore S28/S33/S38
Electrical Schematic 6/02
(for machines with a 41135C Traverse Controller)

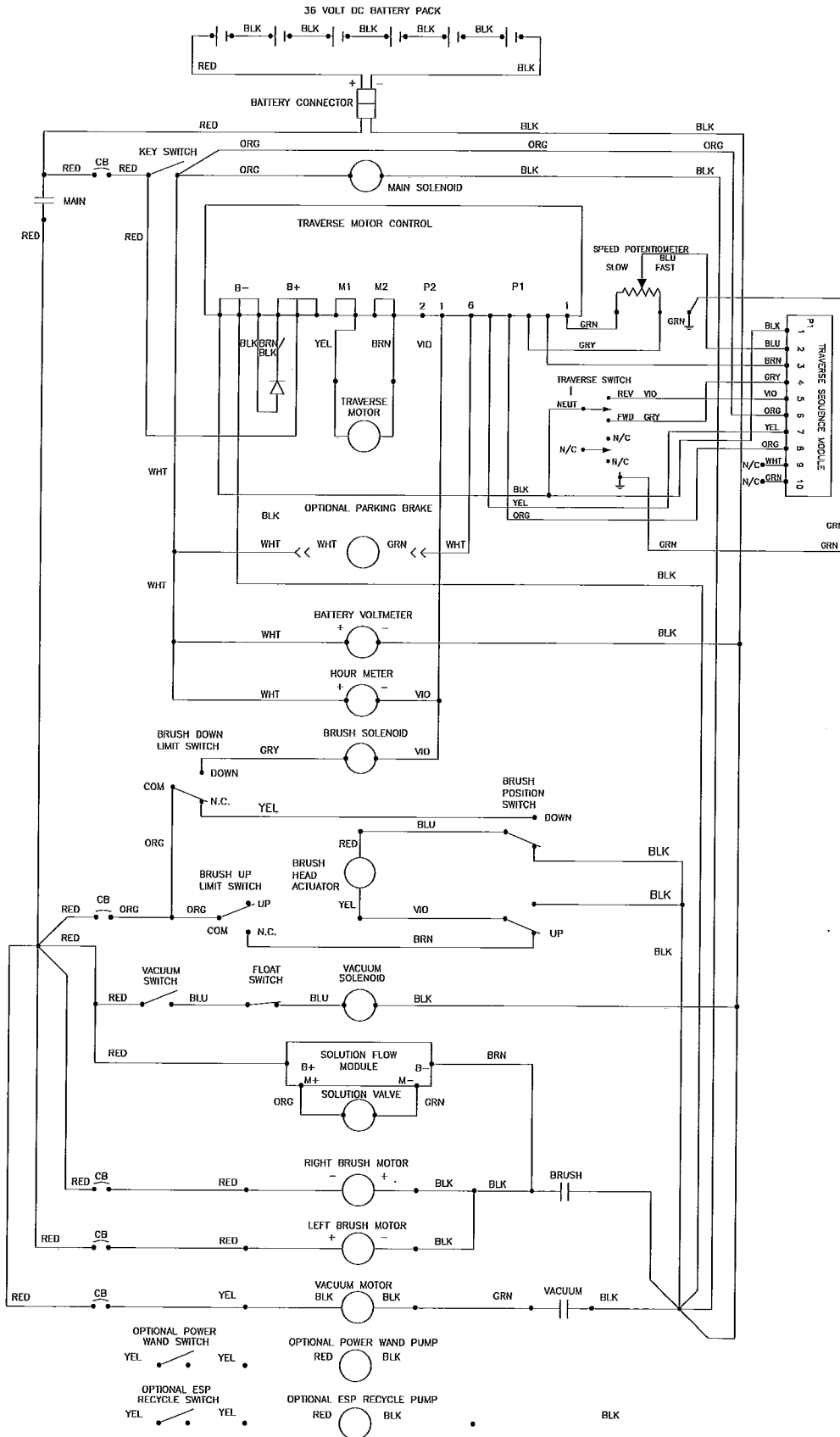

Clarke® Encore S28/S33/S38
Connection Diagram 6/02
(for machines with a 41135C Traverse Controller)

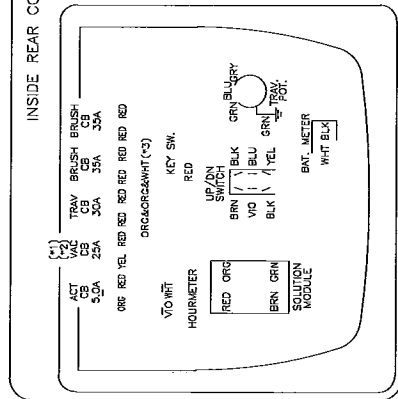
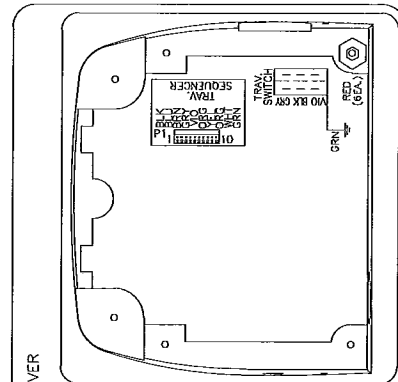
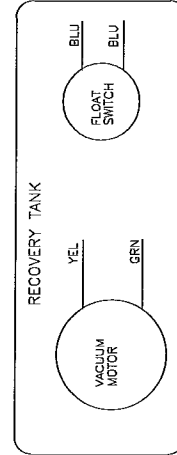
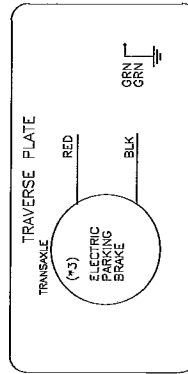
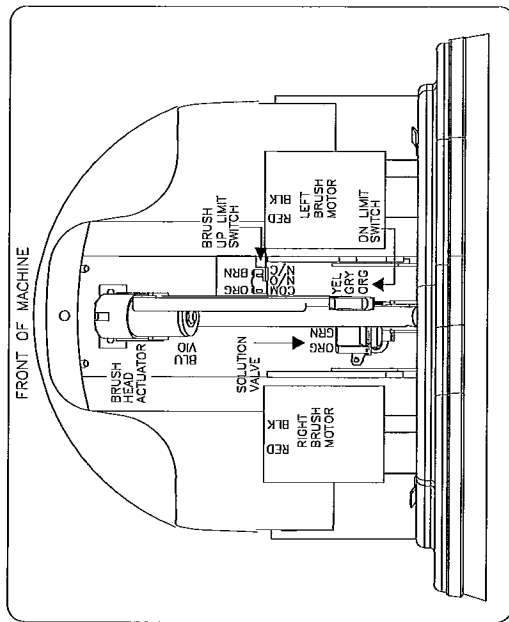
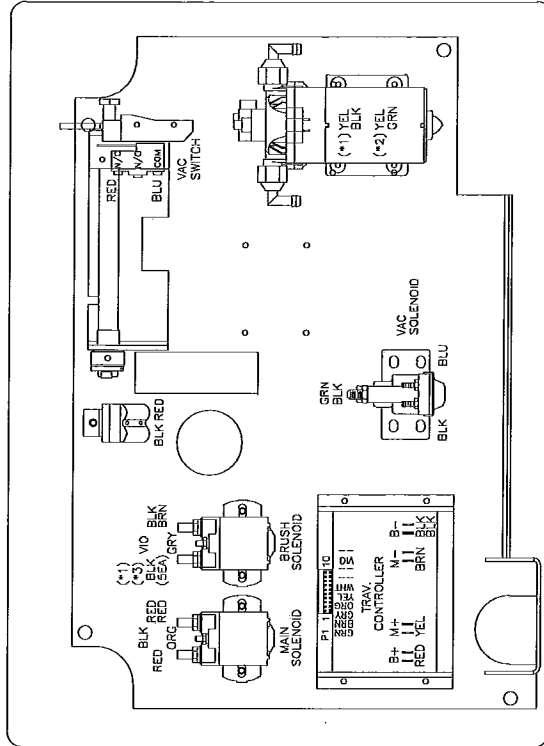

- (1) ESP RECOVERY SYSTEM OPTION.
- (2) POWERMATE SYSTEM OPTION.
- (3) ELECTRIC PARKING BRAKE OPTION.