



REPAIR PARTS LIST

SC6005A

FLOOR MACHINE - 15" 1 HP

Date: August 5, 2003

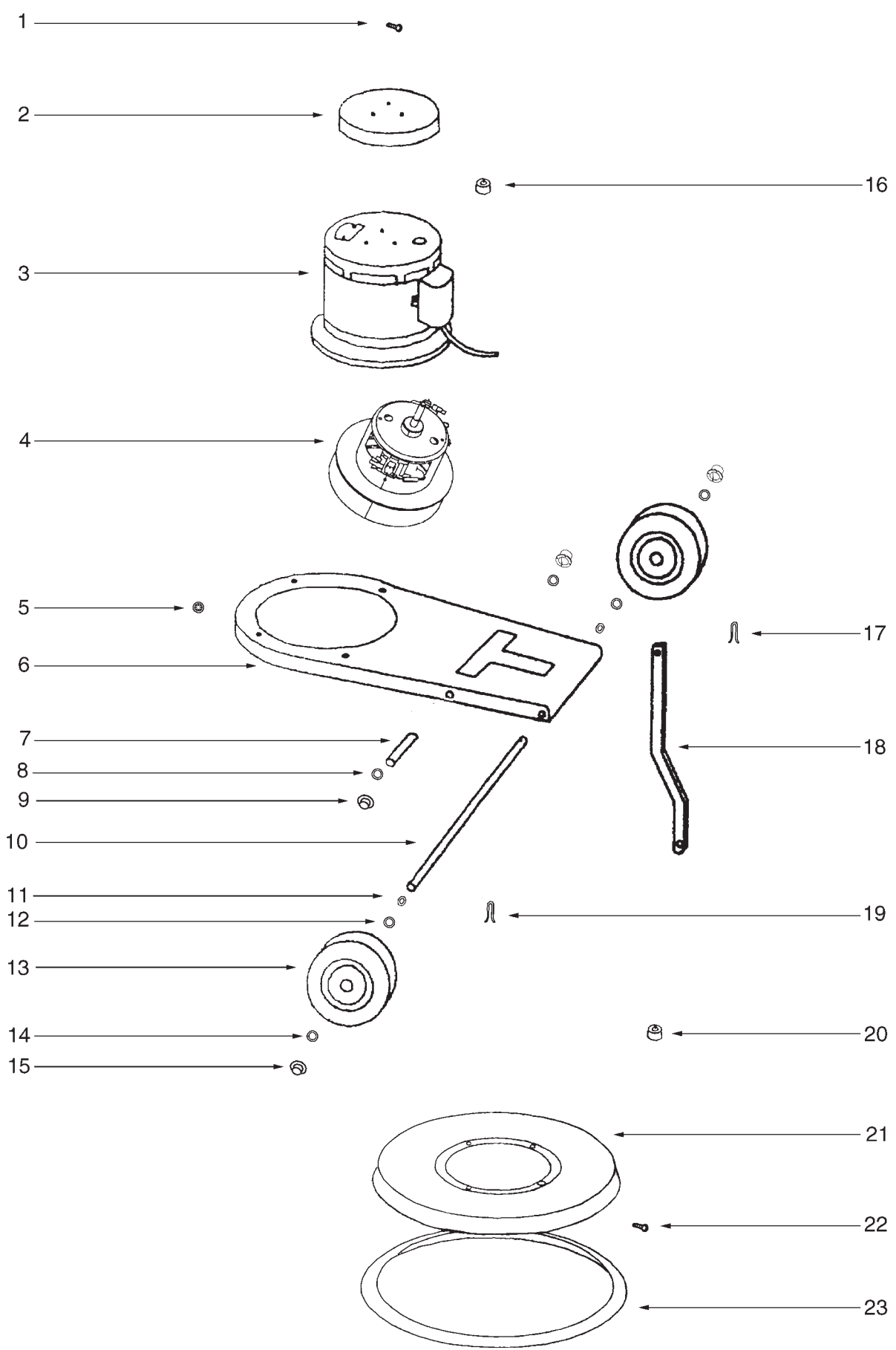

SC6005A

1.	H0002	SCREW 10-24 X 1
2.	S0001CP	DRIP COVER
3.	G0001P	GEAR UNIT
4.	E0001P	MOTOR
5.	H0005	LOCK WASHER
6.	W0001P-1	FRAME
7.	M0006P	SHAFT
8.	H0008	WASHER 33/64" X 7/8"
9.	H0009	PUSH NUT .5"
10.	M0005P	AXLE
11.	H0007	SPRING WASHER
12.	H0008	WASHER 33/64" X 7/8"
13.	C0004	WHEEL
14.	H0008	WASHER 33/64" X 7/8"
15.	H0009	PUSH NUT .5"
16.	H0003-1	SPACER
17.	H0006	COTTER PIN
18.	S0005P-1	CONNECTING LEG
19.	H00031	COTTER PIN
20.	M0004	SPACER
21.	S0038CP	BRUSH COVER
22.	H0011	SCREW 5/16" X 2 SOC. HD.
23.	C0029-1	BUMPER

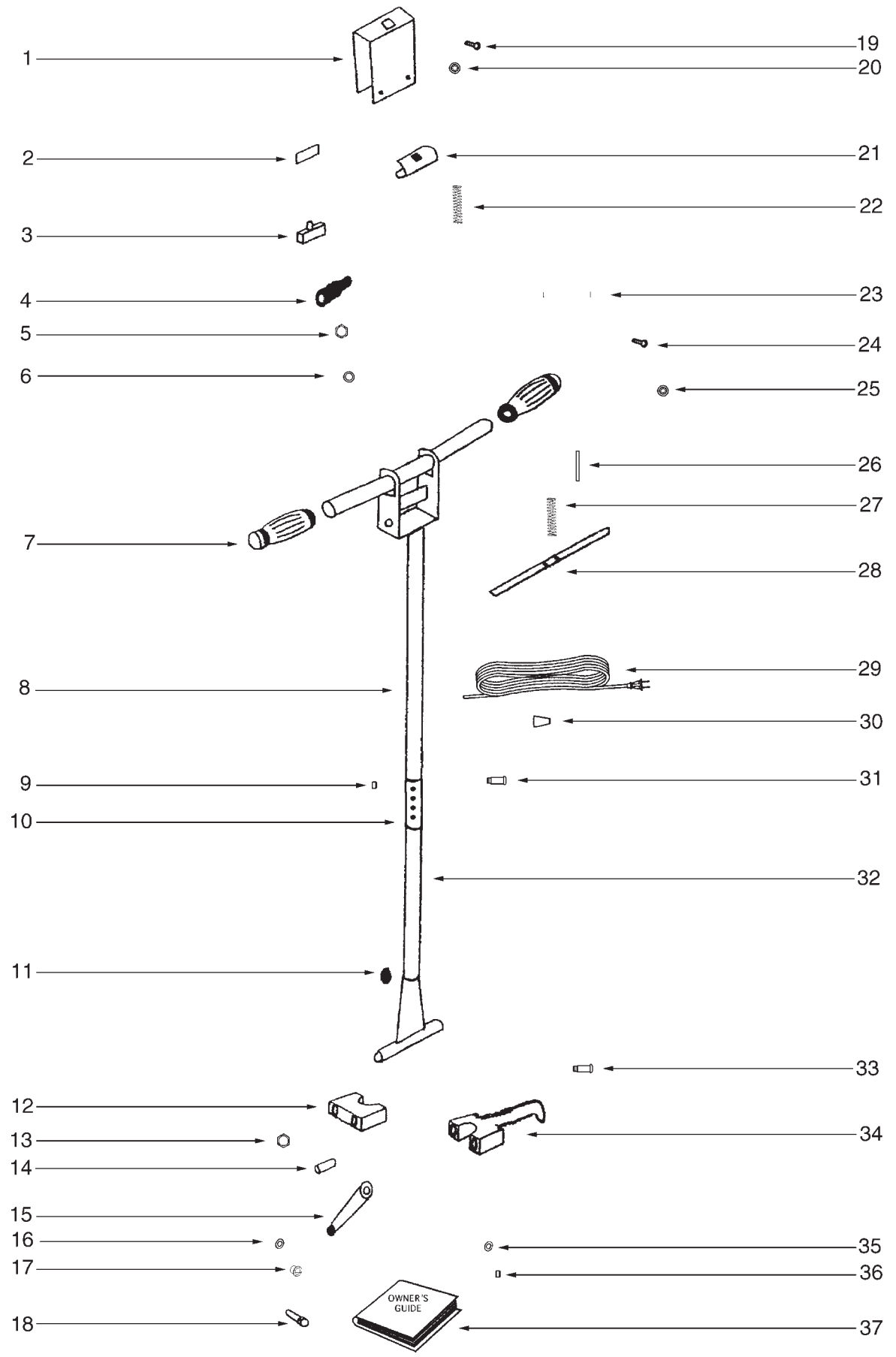

SC6005A

1.	W0003-2P	SWITCHBOX COVER
2.	H0013	SWITCH INSULATION
3.	E0007	SWITCH - ON/OFF
4.	H0021	STRAIN RELIEF
5.	H0022	STRAIN RELIEF NUT
6.	H0022-1	STRAIN RELIEF WASHER
7.	C0007-2	HANDLE GRIP
8.	W0002UP	UPPER HANDLE
9.	H0099	NUT 5/16" - 18
10.	M0027P	HANDLE COUPLING
11.	H0028	GROMMET
12.	C0006P-1	HANDLE LOCK CLAMP
13.	H0015	NUT 3/8" - 16
14.	H0017	SPADE BOLT
15.	M0001P2	HANDLE LOCK CAM
16.	H0001P	WASHER
17.	H0019	PUSH NUT 5/16"
18.	H0018	RIVET 5/16" X 1.25"
19.	H0040	SCREW 10-24 X .5 PAN HD.
20.	H0020	LOCK WASHER
21.	C0003	SAFETY SWITCH
22.	H0014	SPRING
23.	H0062	POWER CORD CLAMP
24.	H0040	SCREW 10-24 X .5 PAN HD.
25.	H0020	LOCK WASHER
26.	H0012	ROLL PIN
27.	H0023	TRIGGER SPRING
28.	S0008P-1	TRIGGER
29.	E0003G	POWER CORD
30.	H0027	WIRE NUT
31.	H0098	BOLT 5/16" - 18 X 2
32.	W0002LP	LOWER HANDLE
33.	H0044	BOLT 3/8" - 16 X 2.5
34.	C0008P-1	CORD HOOK
35.	H0016	WASHER 3/8"
36.	H0057	NUT 3/8" - 16
37.	73416	OWNER'S GUIDE