

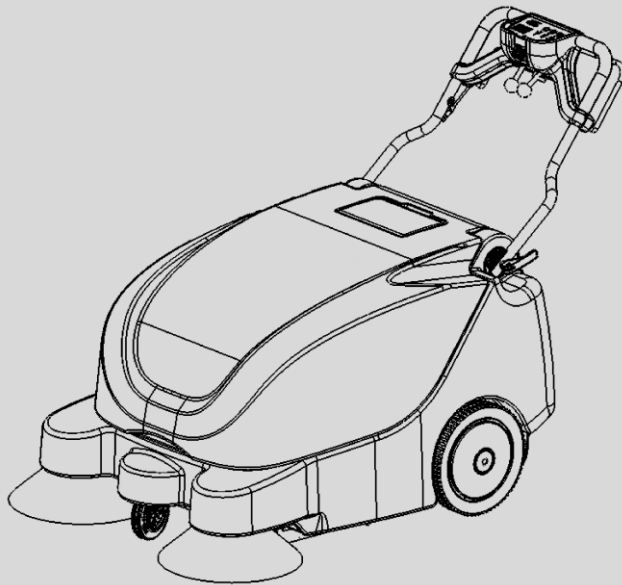

S9



Battery powered automatic walk-behind sweeper

Barredora de batería con operario a pie

Balayeuse à conducteur marchant automatique alimentée par batterie

Varredora à bateria de condução apeeda automática à bateria

电瓶供电手推自走式自动扫地机

Model Part No.:
Without Battery
1069648 – S9 NA
9010186 – S9 EX
9010140 – S9 AUS/CN
With Battery
1071366 – S9 NA/EX
9010145 – S9 CN
9010187 – S9 AUS

Operator and Parts Manual (EN)

Manual de funcionamiento y lista de componentes (ES)

Manuel de fonctionnement et liste des pièces (FR)

Manual de Instruções e de Peças (PT)

操作与零部件手册 (CN)

TwinMax™ Technology

Tennant True® Parts



www.tennantco.com/manuals

9009634
Rev. 02 (03-2013)

Introduction

This manual is furnished with each new model. It provides necessary operation and maintenance instructions and replacement parts information.



Read all instructions before using this machine.

Intended Use

This battery powered automatic walk-behind sweeper is intended for commercial use, for example in buildings, warehouses, parking lots and sidewalks. It is designed for indoor and outdoor use and suitable for picking up dry, nonflammable dust and debris on dry hard floor and carpet surfaces. It is not suitable for wet surfaces or for picking up flammable or hazardous materials.

General Information

This machine will provide excellent service. However, the best results will be obtained at minimum costs if:

- The machine is operated with reasonable care.
- The machine is maintained regularly - per the machine maintenance instructions provided.
- The machine is maintained with manufacturer-supplied or equivalent parts.



Protect the Environment

Please dispose of packaging materials and used machine components in an environmentally safe way according to local waste disposal regulations.



Always remember to recycle.

Technical Specifications

Model	S9
Length	1085 mm / 43 in
Width	799 mm / 31 in
Height	658 mm / 26 in
Weight	137 kg / 300 lb
Sweeping Path Width	900 mm / 35 in
Main Brush Width	500 mm / 20 in
Side Brush Diameter	354 mm / 14 in
Hopper Capacity	60 L / 15.9 Gal
Battery Capacity	12 V, 105 Ah (C5), 120Ah (C20)
Total Power Consumption	12 VDC, 590 W, 34.3 A
Battery Charger	100-240VAC 10A
Run Time (Max.)	3 Hr.
Productivity Rate (Net)	3150 m ² /hr / 23620 ft ² /hr
Slope Maximum	2%
Machine Vibration at Hand-arm *	<2.5m/s ²
Machine Vibration Uncertainty K *	0.8 m/s ²
Sound Pressure Level L _{pA} *	62 dBA
Sound Uncertainty K _{pA} *	3 dBA
Sound Power Level L _{WA} +	81 dB(A)
Uncertainty K _{WA} *	
Protection Grade	IPX3
Operation Temperature	min. -15°C, max. 40°C

* Values determined as per EN 60335-2-72

Tennant Company
 PO Box 1452, Minneapolis, MN 55440 USA
 Phone: (800) 553-8033 or (763) 513-2850
 www.tennantco.com
 Original Instructions. Copyright © 2012 TENNANT Company.
 All rights reserved. Printed in Germany.
 Specifications and parts are subject to change without notice.

Machine Data

Please fill out at time of installation for future reference.
 Model No. - _____
 Serial No. - _____
 Installation Date - _____

IMPORTANT SAFETY INSTRUCTIONS (SAVE THESE INSTRUCTIONS)



This symbol warns the operator of hazards and unsafe practices which could result in severe personal injury or death.



WARNING: To Reduce the Risk of Fire, Explosion, Electric Shock, or Injury:

- Do not use near flammable liquids, vapors or combustible dusts.

The machine is not equipped with explosion proof motors. The electric motors will spark upon start up and during operation which could cause a flash fire or explosion if machine is used in an area where flammable vapors/liquids or combustible dusts are present.

- Do Not Pick Up Flammable or Toxic Materials and Burning Debris.
- Batteries Emit Hydrogen gas. Keep Sparks and Open Flame Away When Charging Batteries.
- Charge batteries in a well ventilated area.
- Disconnect Battery Cable and Charger Cord Before Servicing.
- Do Not Charge Batteries with Damaged Cord. Do Not Modify Plug.
- Do Not Use On Wet Surfaces. Store Indoors.

The following safety precautions signal potentially dangerous conditions to the operator or equipment.

FOR SAFETY:

1. Do not operate machine:
 - Unless trained and authorized.
 - Unless operator manual is read and understood.
 - Unless mentally and physically capable of following machine instructions.
 - In areas that are too dark to safely see the controls or operate the machine.
 - If not in proper operating condition.
 - Without hopper and/or filter in place.
2. Before operating machine:
 - Make sure all safety devices are in place and operate properly.
3. When operating machine:
 - Use only as described in manual.
 - Do not pick up objects such as cords, strings, wires that may entangle brush.
 - Report machine damage or faulty operation immediately.
 - Do not leave unattended or on an unlevel surface.
 - Do not allow children to play on or around machine.
 - Keep children and unauthorized persons away from machine when in use.

- Go slow on slippery surfaces.
 - Do not operate on inclines that exceed 2 %.
 - Do not use machine to transport people or objects.
 - Wear a dust mask, protective glasses and gloves in dusty environments.
 - Keep hands away from spinning brush.
 - Use caution when lifting full hopper to avoid back strain.
 - Wear heavy gloves when removing sharp objects from hopper.
 - Turn machine power off if brush becomes obstructed or machine malfunctions.
- 4. Before leaving or servicing machine:**
- Stop on level surface.
 - Turn machine power off and remove key.
- 5. When servicing machine:**
- Turn machine power off and remove key.
 - Disconnect battery cable and charger cord before working on machine.
 - Wear protective gloves and glasses when handling batteries or battery cables.
 - Avoid contact with battery acid.
 - Use manufacturer supplied or approved replacement parts.
 - All repairs must be performed by a qualified service person.
 - Avoid moving parts. Do not wear loose clothing or jewelry and secure long hair.
 - Do not power spray or hose off machine near electrical components.
 - Do not modify the machine from its original design.
 - Drive wheels off ground during test after drive belt adjustment.
 - All work must be done having enough visibility and/or appropriate lighting.
 - Wear personal protective equipment as needed.
- 6. When transporting machine:**
- Turn machine power off and remove key.
 - Get assistance when lifting machine.
 - Use a loading ramp that will support the weight of the machine.
 - Do not wheel up or down stairs.
 - Use tie-down straps to secure machine when transporting by vehicle.

Onboard Battery Charger Information

The onboard battery charger's charging profile is specifically configured for a 12V sealed GEL battery. When installing a replacement battery it is important to use the same battery type or damage to the battery and/or charger may result.

For battery charger operating instructions, refer to the battery charger manual supplied with the machine.

Safety Label

The safety label appears on the machine in the location indicated. Replace label if missing, damaged or illegible.

⚠ WARNING
<p>TO REDUCE THE RISK OF FIRE, ELECTRIC SHOCK, OR INJURY:</p> <ul style="list-style-type: none"> • Do Not Use Near Flammable Liquids, Vapors or Combustible Dusts. • Do Not Pick Up Flammable or Toxic Materials and Burning Debris. • Keep Sparks and Open Flame Away When Charging Batteries. • Disconnect Battery Cables and Charger Cord Before Servicing. • Do Not Charge Batteries With Damaged Cord. Do Not Modify Plug. • Do Not Use On Wet Surfaces. Store Indoors.
⚠ AVERTISSEMENT
<p>POUR RÉDUIRE LES RISQUES D'INCENDIE, DE CHOC ÉLECTRIQUE OU DE BLESSURE:</p> <ul style="list-style-type: none"> • N'utilisez Pas Près de Liquides, Vapeurs ou Poussières Inflammables. • Ne Ramassez Pas de Matériaux Inflammables ou Toxiques et de Déchets Enflammés. • Eloignez les Sources d'Étincelles ou de Flamme Ouverte Lors du Chargement des Batteries. • Débranchez les Câbles de Batterie et la Cordon du Chargeur Avant l'Entretien. • Ne Chargez Pas la Batterie Avec un Cordon Endommagé. Ne Modifiez Pas la Prise. • N'utilisez Pas Sur des Surfaces Humides. Entrez à l'Intérieur.
⚠ ADVERTENCIA
<p>PARE REDUCIR EL RIESGO DE INCENDIO, CHOQUE ELÉCTRICO, O LESIONES:</p> <ul style="list-style-type: none"> • No Use Cerca De Líquidos Flamables, Vapores Ó Materiales Combustibles. • No Recoja Materiales Flamables Ó Tóxicos Ni Desechos Candescentes. • Mantenga Chispas Y Fuego Alejados Mientras Carga Baterías. • Desconecte Cable De Batería Y Cable Del Cargador Antes Del Mantenimiento. • No Cargue Baterías Con Cable Dañado. No Altere El Enchufe. • No Lo Utilice En Superficies Húmedas. Guarde Bajo Techo.
1071275



Introducción

Este manual se incluye en todos los modelos nuevos. Proporciona la información necesaria para su utilización, mantenimiento y cómo reponer las piezas.



Lea todas las instrucciones antes de utilizar esta máquina.

Uso previsto

Esta barredora de batería con operario a pie está pensada para su uso comercial en edificios, almacenes, aparcamientos y aceras, entre otros. Está diseñado para interior y exterior y además recoge el polvo y los restos de suciedad secos y no inflamables de los suelos secos y alfombras. No es apropiado para superficies mojadas o para recoger materiales inflamables o peligrosos.

Información general

Esta máquina ofrece un funcionamiento excelente. Sin embargo, los resultados serán óptimos a un coste mínimo si:

- Maneja la máquina con un cuidado razonable.
- Realiza las operaciones de mantenimiento regularmente y de acuerdo con las instrucciones adjuntas.
- Las operaciones de mantenimiento de la máquina se realizan con piezas suministradas por el fabricante o equivalentes.



Proteja el medio ambiente

Deseche el material de embalaje y los componentes usados de la máquina de forma segura para el medio ambiente, de acuerdo con las normas locales sobre desecho de residuos.

No olvide reciclar.

Especificaciones técnicas

Modelo	S9
Longitud	1085 mm / 43 in
Anchura	799 mm / 31 in
Altura	658 mm / 26 in
Peso	137 kg / 300 lb
Anchura de la pista de barrido	900 mm / 35 in
Anchura del cepillo principal	500 mm / 20 in
Diámetro del cepillo lateral	354 mm / 14 in
Capacidad de la caja colectora	60 L / 15.9 Gal
Capacidad de la batería 12V,	12 V, 105 Ah (C5), 120Ah (C20)
Consumo total de energía	12 VDC, 590 W, 34.3 A
Cargador de baterías	100-240VAC 10A
Tiempo de operación (máx.)	3 Hr.
Productividad media (neta)	3150 m ² /hr / 23620 ft ² /hr
Inclinación máxima	2%
Vibraciones de la máquina en brazos y manos*	<2.5m/s ²
Incertidumbre de la vibración K *	0.8 m/s ²
Nivel de presión acústica L _{PA} *	62 dBA
Incertidumbre acústica K _{PA} *	3 dBA
Nivel de potencia acústica L _{WA} + Incertidumbre K _{WA} *	81 dB(A)
Índice de protección	IPX3
temperatura de operación	min. -15°C, max. 40°C

* Valores determinados según EN 60335-2-72

Tennant Company
 PO Box 1452, Minneapolis, MN 55440 USA
 Teléfono: 001-800-553-8033 o 001-763- 513-2850
 www.tennantco.com
 Instrucciones originales. Copyright © 2012 TENNANT Company.
 Todos los derechos reservados. Impreso en Alemania.
 Las características técnicas y las piezas están sujetas a modificaciones sin previo aviso.

Datos de la máquina

Rellene esta ficha cuando realice la instalación, para utilizarla como referencia en el futuro.

Número de modelo - _____

Número de serie - _____

Fecha de instalación - _____

MEDIDAS DE SEGURIDAD (GUARDE ESTAS INSTRUCCIONES)



Este símbolo advierte al operario de los riesgos y hábitos peligrosos que podrían causar lesiones corporales graves o mortales.



ADVERTENCIA: para reducir el riesgo de incendios, explosiones, descargas eléctricas o lesiones:

- No utilice la máquina cerca de líquidos, polvos o vapores inflamables.

Esta máquina no está equipada con motores a prueba de explosiones. Los motores eléctricos producirán chispas tanto durante el arranque como durante su utilización que pueden provocar incendios o explosiones si utiliza la máquina en presencia de líquidos o vapores inflamables o partículas combustibles.

- No recoja materiales tóxicos o inflamables ni residuos humeantes o ardiendo.
- Las baterías emiten hidrógeno. Mantenga brasas o fuego alejados cuando cargue las baterías.
- Cargue siempre las baterías en un lugar bien ventilado.
- Desconecte los cables de batería y el enchufe del cargador antes de realizar operaciones de mantenimiento en la máquina.
- No cargue las baterías si el cable está dañado. No modifique el enchufe.
- No utilice la máquina sobre superficies mojadas. Guárdela en un lugar cerrado.

Las siguientes medidas de seguridad hacen referencia a situaciones potencialmente peligrosas para el operario o el equipo.

SEGURIDAD:

1. No utilice la máquina:

- A no ser que cuente con la formación y autorización adecuada.
- A no ser que haya leído y comprendido el manual del operario.
- A no ser que tenga la capacidad física y mental para seguir las instrucciones de la máquina.
- En lugares demasiado oscuros para ver los controles o utilizar la máquina con seguridad.
- Si la máquina no funciona correctamente.
- Sin haber colocado los filtros y/o la caja recolectora.

2. Antes de utilizar la máquina:

- Asegúrese de que todos los dispositivos de seguridad están bien instalados y funcionan correctamente.

3. Al utilizar la máquina:

- Utilice la máquina solamente como se describe en el manual.
- No recoja objetos como cuerdas, hilos o cables que pudieran enredar el cepillo.
- Informe inmediatamente de las averías de la máquina o de si el funcionamiento no es correcto.
- Vigile la máquina en todo momento y no la deje en una superficie inestable.
- No permita que los niños jueguen encima o alrededor de la máquina.
- Mantenga a los niños y a las personas no autorizadas alejados de la máquina mientras esté en uso.

- Vaya despacio en superficies resbaladizas.
- No utilice la máquina en superficies inclinadas que excedan el 2%.
- No utilice la máquina para transportar personas u objetos.
- En ambientes con mucho polvo, protéjase con una mascarilla contra el polvo, gafas y guantes.
- Cepillo giratorio. Mantenga alejadas las manos
- Sea precavido cuando levante la caja colectorora llena para evitar dolores de espalda.
- Protéjase con guantes cuando retire objetos punzantes del filtro.
- Apague la máquina si no está funcionando correctamente o si el cepillo se bloquea.

4. Antes de dejar la máquina o realizar operaciones de mantenimiento:

- Detenga la máquina en una superficie plana.
- Apague la máquina y retire la llave.

5. Cuando realice operaciones de mantenimiento:

- Apague la máquina y retire la llave.
- Desconecte el cable de la batería y el del cargador antes realizar las operaciones de mantenimiento.
- Utilice guantes y gafas de protección al trabajar con las baterías o sus cables.
- Evite el contacto con el ácido de las baterías.
- Utilice repuestos suministrados o aprobados por el fabricante.
- Todas las reparaciones debe realizarlas personal técnico cualificado.
- Evite las partes en movimiento. No lleve prendas sueltas ni joyas y recójase el pelo si lo tiene largo.
- No moje la máquina rociándola o utilizando una manguera cuando esté cerca de componentes eléctricos.
- No modifique el diseño original de la máquina.
- Levante las ruedas del suelo durante la prueba tras ajustar las correas.
- Todos los trabajos deben realizarse con visibilidad suficiente e iluminación adecuada.
- Protéjase llevando las prendas o equipo adecuados.

6. Al transportar la máquina:

- Apague la máquina y retire la llave.
- Pida ayuda para levantar la máquina.
- Utilice una rampa de carga capaz de soportar el peso de la máquina.
- No baje ni suba escaleras utilizando las ruedas de la máquina.
- Utilice las correas de sujeción para fijar la máquina cuando la transporte en un vehículo.

Información sobre el cargador de batería integrado

El tipo de carga que realiza el cargador de batería integrado está específicamente configurado para cargar una batería sellada GEL de 12V. Cuando se cambia la batería, es importante utilizar el mismo tipo de batería. En caso contrario la batería o el cargador podrían resultar dañados.

Para las instrucciones de uso del cargador, consulte el manual del cargador de batería que se incluye con la máquina.

Adhesivo de seguridad

El adhesivo de seguridad se encuentra en la posición indicada a continuación. Sustituya el adhesivo si se ha perdido, está deteriorado o es ilegible.

⚠ WARNING	
	
TO REDUCE THE RISK OF FIRE, ELECTRIC SHOCK, OR INJURY: <ul style="list-style-type: none"> • Do Not Use Near Flammable Liquids, Vapors or Combustible Dusts. • Do Not Pick Up Flammable or Toxic Materials and Burning Debris. • Keep Sparks and Open Flame Away When Charging Batteries. • Disconnect Battery Cables and Charger Cord Before Servicing. • Do Not Charge Batteries With Damaged Cord. Do Not Modify Plug. • Do Not Use On Wet Surfaces. Store Indoors. 	
⚠ AVERTISSEMENT	
POUR RÉDUIRE LES RISQUES D'INCENDIE, DE CHOC ÉLECTRIQUE OU DE BLESSURE: <ul style="list-style-type: none"> • N'utilisez Pas Près de Liquides, Vapeurs ou Poussières Inflammables. • Ne Ramassez Pas de Matériaux Inflammables ou Toxiques et de Déchets Enflammés. • Éloignez les Sources d'Étincelles ou de Flamme Ouverte Lors du Chargement des Batteries. • Débranchez les Câbles de Batterie et la Cordon du Chargeur Avant l'Entretien. • Ne Chargez Pas la Batterie Avec un Cordon Endommagé. Ne Modifiez Pas la Prise. • N'utilisez Pas Sur des Surfaces Humides. Entrez à l'Intérieur. 	
⚠ ADVERTENCIA	
PARE REDUCIR EL RIESGO DE INCENDIO, CHOQUE ELÉCTRICO, O LESIONES: <ul style="list-style-type: none"> • No Use Cerca De Líquidos Flamables, Vapores Ó Materiales Combustibles. • No Recoja Materiales Flamables Ó Tóxicos Ni Desechos Candescentes. • Mantenga Chispas Y Fuego Alejados Mientras Carga Baterías. • Desconecte Cable De Batería Y Cable Del Cargador Antes Del Mantenimiento. • No Cargue Baterías Con Cable Dañado. No Altere El Enchufe. • No Lo Utilice En Superficies Húmedas. Guarde Bajo Techo. 	
1071275	



Introduction

Ce manuel accompagne chaque nouveau modèle. Il fournit les instructions nécessaires au fonctionnement et à l'entretien, ainsi que les informations relatives au remplacement des pièces.



Lisez toutes les instructions avant d'utiliser cette machine.

Utilisation prévue

Cette balayeuse à conducteur marchant automatique alimentée par batterie est destinée à un usage commercial (par exemple, dans les bâtiments, entrepôts, parcs de stationnement et trottoirs. Elle peut être utilisée à l'intérieur et à l'extérieur, et permet de ramasser la poussière sèche et non-inflammable, ainsi que les déchets sur sol dur et sec et les surfaces des moquettes. Elle ne peut pas être utilisée sur des surfaces humides ou pour le ramassage de matériaux inflammables ou toxiques.

Informations générales

Cette machine fournit d'excellents services. Toutefois, vous obtiendrez les meilleurs résultats, à moindre coût, si :

- La machine doit être manipulée avec précaution.
- La machine fait l'objet d'un entretien régulier, conformément aux instructions d'entretien fournies.
- L'entretien de la machine s'effectue avec les pièces fournies par le fabricant ou des pièces équivalentes.



Protection de l'environnement

Pour éliminer les matériaux d'emballage et les composants usagés de la machine en respectant l'environnement, respectez les réglementations locales en vigueur concernant la mise au rebut des déchets.



Pensez toujours à recycler.

Caractéristiques techniques

Modèle	S9
Longueur	1085 mm / 43 in
Largeur	799 mm / 31 in
Hauteur	658 mm / 26 in
Poids	137 kg / 300 lb
Largeur de la trace de balayage	900 mm / 35 in
Largeur de la brosse principale	500 mm / 20 in
Diamètre de la brosse latérale	354 mm / 14 in
Capacité du bac à déchets	60 L / 15.9 Gal
Capacité de la batterie 12 V,	12 V, 105 Ah (C5), 120Ah (C20)
Consommation électrique totale	12 VDC, 590 W, 34.3 A
Chargeur de la batterie	100-240VAC 10A
Autonomie (max.)	3 Hr.
Taux de rendement (net)	3150 m ² /hr / 23620 ft ² /hr
Pente maximum	2%
Vibrations de la machine au niveau du système main-bras *	<2.5m/s ²
Incertitude de vibrations de la machine K *	0.8 m/s ²
Niveau de pression acoustique L _{pA} *	62 dBA
Incertitude acoustique K _{pA} *	3 dBA
Niveau de puissance acoustique L _{WA} + incertitude K _{WA} *	81 dB(A)
Degré de protection	IPX3
température de fonctionnement	min. -15°C, max. 40°C

* Valeurs déterminées conformément à la norme EN 60335-2-72

Tennant Company
PO Box 1452, Minneapolis, MN 55440 États-Unis d'Amérique
Téléphone : (800) 553-8033 ou (763) 513-2850
www.tennantco.com
Instructions d'origine. Copyright © 2012 TENNANT Company.
Tous droits réservés. Imprimé en Allemagne.
Les caractéristiques et les pièces sont susceptibles d'être modifiées sans avis préalable.

Données de la machine

À remplir au moment de l'installation pour s'y référer ultérieurement.

N° de modèle - _____

N° de série - _____

Date d'installation - _____

CONSIGNES DE SÉCURITÉ IMPORTANTES (CONSERVEZ CES INSTRUCTIONS)



Ce symbole avertit l'opérateur de situations à risque ou de pratiques dangereuses pouvant provoquer des blessures graves, voire mortelles.

AVERTISSEMENT : Afin de réduire le risque d'incendie, d'explosion, de choc électrique ou de blessure :



- N'utilisez pas la machine à proximité de liquides ou de vapeurs inflammable, ni de poussières combustibles.

La machine n'est pas équipée de moteurs protégés contre les explosions. Les moteurs électriques génèrent des étincelles au moment du démarrage et pendant leur fonctionnement, ce qui peut entraîner un incendie instantané ou une explosion si la machine est utilisée dans une zone où des vapeurs/liquides inflammables ou des poussières combustibles sont présents.

- Ne ramassez pas de matériaux inflammables ou toxiques, ni de déchets incandescents.
- Les batteries émettent du gaz hydrogène. Éloignez les sources d'étincelles ou de flammes ouvertes lors du chargement des batteries.
- Rechargez les batteries dans un endroit bien aéré.
- Débranchez les câbles de la batterie et le cordon du chargeur avant l'entretien.
- Ne chargez pas la batterie avec un cordon endommagé. Ne modifiez pas la prise.
- N'utilisez pas la machine sur des surfaces humides. Entrez la machine à l'intérieur.

Les consignes de sécurité mentionnées ci-après indiquent les situations présentant un danger pour l'opérateur ou l'équipement.

POUR VOTRE SÉCURITÉ :

1. N'utilisez pas la machine :
 - Si vous n'y êtes pas formé et autorisé.
 - Avant d'avoir lu et compris le manuel d'utilisation.
 - Si vous n'êtes pas mentalement et physiquement capable de suivre les instructions d'utilisation de la machine.
 - Dans les endroits trop sombres pour pouvoir distinguer les commandes de la machine ou l'utiliser en toute sécurité.
 - Si elle n'est pas en bon état de marche.
 - Sans bac à déchets et/ou filtre en place.
2. Avant de mettre la machine en marche :
 - Assurez-vous que tous les dispositifs de sécurité sont en place et fonctionnent correctement.
3. Lors de l'utilisation de la machine :
 - Utilisez la machine uniquement tel qu'indiqué dans ce manuel.
 - Ne ramassez pas d'objets susceptibles de se coincer dans la brosse (tel que des cordes, ficelles ou fils).
 - Signalez immédiatement tout dommage ou dysfonctionnement.
 - Ne laissez jamais la machine sans surveillance ou sur une surface non plane.
 - Empêchez les enfants de jouer à proximité de la machine.
 - Maintenez les enfants et les personnes non autorisées à l'écart de la machine pendant son utilisation.

- Roulez lentement sur les surfaces glissantes.
 - N'utilisez pas la machine sur des pentes dépassant 2 %.
 - N'utilisez pas la machine pour transporter des personnes ou des objets.
 - Portez un masque antipoussière, des lunettes protectrices et des gants dans les environnements poussiéreux.
 - Brosse en rotation. Éloignez vos mains.
 - Lors du levage des bacs à déchets pleins, faites attention à ne pas vous faire un tour de reins.
 - Portez des gants renforcés pour ramasser les objets tranchants des bacs à déchets.
 - Mettez la machine hors tension si la brosse se coince ou la machine ne fonctionne pas correctement.
4. Avant de quitter la machine ou d'en effectuer l'entretien :
- Arrêtez-la sur une surface plane.
 - Mettez la machine hors tension et retirez la clé.
5. Lors de l'entretien de la machine :
- Mettez la machine hors tension et retirez la clé.
 - Débranchez le câble de la batterie et la prise du chargeur avant de travailler sur la machine.
 - Portez des gants et des lunettes de protection lorsque vous manipulez les batteries ou les câbles de batterie.
 - Évitez tout contact avec l'acide des batteries.
 - Utilisez des pièces de rechanges fournies ou approuvées par le fabricant.
 - Toutes les réparations doivent être effectuées uniquement par un technicien qualifié.
 - Évitez les pièces mobiles. Ne portez pas de vêtements amples et attachez vos cheveux s'ils sont longs.
 - N'utilisez pas de jet ou de tuyau de pression à proximité des composants électriques de la machine.
 - Ne modifiez pas la conception d'origine de la machine.
 - Dégagez les roues motrices du sol lors du test suivant le réglage de la courroie d'entraînement.
 - Tous les travaux doivent être exécutés avec une visibilité suffisante et/ou un éclairage approprié.
 - Portez un équipement de protection approprié.
6. Lors du transport de la machine :
- Mettez la machine hors tension et retirez la clé.
 - Demandez de l'aide pour soulever la machine.
 - Utilisez une rampe de chargement capable de supporter le poids de la machine.
 - Ne faites pas rouler la machine dans les escaliers.
 - En cas de transport par véhicule, arrimez la machine avec des sangles.

Informations concernant le chargeur de batterie embarqué

Le profil du chargeur de batterie embarqué est spécialement conçu pour une batterie GEL scellée de 12 V. Lors de l'installation ou du remplacement d'une batterie, il est important d'utiliser une batterie du même type, sans quoi, la batterie et/ou le chargeur peuvent être endommagés.

Pour les instructions de fonctionnement du chargeur de batterie, reportez-vous au manuel fourni avec la machine.

Étiquette de mise en garde

L'étiquette de mise en garde se trouve sur la machine à l'emplacement indiqué. Remplacez toute étiquette manquante, endommagée ou devenue illisible.

⚠ WARNING	
	
TO REDUCE THE RISK OF FIRE, ELECTRIC SHOCK, OR INJURY: <ul style="list-style-type: none"> • Do Not Use Near Flammable Liquids, Vapors or Combustible Dusts. • Do Not Pick Up Flammable or Toxic Materials and Burning Debris. • Keep Sparks and Open Flame Away When Charging Batteries. • Disconnect Battery Cables and Charger Cord Before Servicing. • Do Not Charge Batteries With Damaged Cord. Do Not Modify Plug. • Do Not Use On Wet Surfaces. Store Indoors. 	
⚠ AVERTISSEMENT	
POUR RÉDUIRE LES RISQUES D'INCENDIE, DE CHOC ÉLECTRIQUE OU DE BLESSURE: <ul style="list-style-type: none"> • N'utilisez Pas Près de Liquides, Vapeurs ou Poussières Inflammables. • Ne Ramassez Pas de Matériaux Inflammables ou Toxiques et de Déchets Enflammés. • Éloignez les Sources d'Étincelles ou de Flamme Ouverte Lors du Chargement des Batteries. • Débranchez les Câbles de Batterie et la Cordon du Chargeur Avant l'Entretien. • Ne Chargez Pas la Batterie Avec un Cordon Endommagé. Ne Modifiez Pas la Prise. • N'utilisez Pas Sur des Surfaces Humides. Entrez à l'Intérieur. 	
⚠ ADVERTENCIA	
PARE REDUCIR EL RIESGO DE INCENDIO, CHOQUE ELÉCTRICO, O LESIONES: <ul style="list-style-type: none"> • No Use Cerca De Líquidos Flamables, Vapores Ó Materiales Combustibles. • No Recoja Materiales Flamables Ó Tóxicos Ni Desechos Candescentes. • Mantenga Chispas Y Fuego Alejados Mientras Carga Baterías. • Desconecte Cable De Batería Y Cable Del Cargador Antes Del Mantenimiento. • No Cargue Baterías Con Cable Dañado. No Altere El Enchufe. • No Lo Utilice En Superficies Húmedas. Guarde Bajo Techo. 	
1071275	



Introdução

Este manual é distribuído com os modelos novos. Ele fornece as instruções necessárias para operação e manutenção e para substituição de peças.



Leia todas as instruções antes de utilizar esta máquina.

Finalidade

A finalidade desta varredora de empurrar à bateria é o uso comercial, por exemplo, em prédios, armazéns, estacionamentos e calçadas. Ela foi projetada para uso em espaços internos e externos e é adequada para retirar poeira e detritos secos e não-inflamáveis em piso duro seco e superfícies de carpete. Ela não é adequada para superfícies molhadas ou para retirar material inflamável ou perigoso.

Informações gerais

Esta máquina deverá funcionar muito bem. Entretanto, serão obtidos melhores resultados com o mínimo de custos se:

- A máquina for operada com o devido cuidado.
- Houver manutenção regular da máquina; de acordo com as instruções de manutenção fornecidas.
- Houver manutenção da máquina com peças fornecidas pelo fabricante ou peças similares autorizadas.



Proteja o meio ambiente

Descarte o material da embalagem e os componentes usados da máquina de maneira ambientalmente segura de acordo com a regulamentação local de descarte de resíduos.



Lembre-se sempre de reciclar.

Especificações técnicas

Modelo	S9
Comprimento	1085 mm / 43 in
Largura	799 mm / 31 in
Altura	658 mm / 26 in
Peso	137 kg / 300 lb
Largura do caminho de varredura	900 mm / 35 in
Largura da escova principal	500 mm / 20 in
Diâmetro da escova lateral	354 mm / 14 in
Capacidade da caçamba	60 L / 15.9 Gal
Capacidade da bateria 12V,	12 V, 105 Ah (C5), 120Ah (C20)
Consumo total de energia	12 VDC, 590 W, 34.3 A
Carregador de bateria	100-240VAC 10A
Tempo de operação (Máx.)	3 Hr.
Taxa de produtividade (Liq.)	3150 m ² /hr / 23620 ft ² /hr
Inclinação máxima	2%
Vibração máxima quando na mão *	<2.5m/s ²
Incerteza da vibração da máquina K *	0.8 m/s ²
Nível da pressão do som L _{PA} *	62 dBA
Incerteza do som K _{PA} *	3 dBA
Nível de potência do som L _{WA} + Incerteza K _{WA} *	81 dB(A)
Grau de proteção	IPX3
temperatura de operação	min. -15°C, max. 40°C

* Valores determinados de acordo com EN 60335-2-72

Tennant Company

Caixa Postal 1452, Minneapolis, MN 55440 EUA

Telefone: (800) 553-8033 ou (763) 513-2850

www.tennantco.com

Instruções originais. Copyright © 2012 TENNANT Company.

Todos os direitos reservados. Impresso na Alemanha.

Especificações e peças sujeitas a alterações sem aviso prévio.

Dados da máquina

Preencha estes dados durante a instalação para referência futura.

Nº do Modelo - _____

Nº de Série - _____

Data de Instalação - _____

INSTRUÇÕES DE SEGURANÇA IMPORTANTES (GUARDE ESTAS INSTRUÇÕES)



Este símbolo adverte o operador dos perigos e práticas perigosas que podem causar ferimentos graves ou morte.



AVISO: Para reduzir o risco de incêndio, explosão, choque elétrico ou ferimento:

- Não use próximo a líquidos ou vapores inflamáveis ou pós combustíveis.

Esta máquina não está equipada com motores à prova de explosão. Os motores elétricos soltarão faíscas ao serem ligados e durante a operação, o que pode causar chamas ou explosão se a máquina for usada em um local onde estejam presentes vapores/líquidos inflamáveis ou pós combustíveis.

- Não faça a coleta de material inflamável ou tóxico e de detritos em chamas.
- As baterias emitem gás de hidrogênio. Mantenha as faíscas e as chamas abertas distantes ao recarregar as baterias.
- Recarregue as baterias em uma área bem ventilada.
- Desconecte os cabos da bateria e a tomada do carregador antes de fazer a manutenção da máquina.
- Não recarregue baterias se o cabo de alimentação estiver danificado. Não modifique o plugue.
- Não utilizar em superfícies molhadas. Armazene em um local fechado.

Os símbolos de precaução de segurança a seguir alertam quanto a possíveis condições de risco para o operador ou equipamento.

MEDIDA DE SEGURANÇA:

1. Não opere a máquina:
 - A menos que tenha sido treinado e autorizado.
 - A menos que tenha lido e compreendido o Manual de Operação.
 - A menos que seja mentalmente e fisicamente capaz de seguir as instruções da máquina.
 - Em áreas em que a escuridão impede de ver os controles ou operar a máquina.
 - Se ela não estiver em condições apropriadas de operação.
 - Sem que a caçamba e/ou o filtro esteja no lugar.
2. Antes de operar a máquina:
 - Certifique-se de que todos os dispositivos de segurança estão na posição correta e operando apropriadamente.
3. Ao operar a máquina:
 - Utilize somente conforme a descrição deste manual.
 - Não faça a coleta de objetos como cordas, fitas e cabos que podem embolar na escova.
 - Notifique imediatamente qualquer dano na máquina ou falha na operação.
 - Não deixe sem supervisão ou em superfície desnivelada.
 - Mantenha distante de crianças.
 - Mantenha crianças ou pessoas não autorizadas distantes da máquina quando ela estiver sendo usada.

- Desloque-se lentamente em superfícies escorregadias.
 - Não opere a máquina em declives maiores do que 2%.
 - Não utilize a máquina para transportar pessoas ou objetos.
 - Use uma máscara contra poeira, óculos protetores e luvas em ambientes empoeirados.
 - Escova rotativa. Mantenha longe do alcance das mãos.
 - Tenha cuidado ao levantar a caçamba para evitar machucar as costas.
 - Use luvas pesadas ao remover objetos pontiagudos do caçamba.
 - Desligue a máquina se a escova for obstruída ou se a máquina tiver um defeito.
4. Antes de deixar a máquina ou de fazer a manutenção:
- Pare em uma superfície plana.
 - Desligue a máquina e retire a chave.
5. Ao fazer a manutenção da máquina:
- Desligue a máquina e retire a chave.
 - Desconecte o cabo da bateria e a tomada do carregador antes de fazer a manutenção da máquina.
 - Use luvas protetoras e óculos ao manusear baterias ou cabos de baterias.
 - Evite o contato com as substâncias ácidas da bateria.
 - Use somente peças fornecidas pela TENNANT ou peças similares.
 - Todos os consertos devem ser feitos por uma equipe de serviços qualificada.
 - Evite peças móveis. Não use roupas largas nem joias e proteja cabelos longos.
 - Não utilize jatos de água sob pressão ou qualquer jato de água próximo de componentes elétricos.
 - Não modifique o design original da máquina.
 - Retire as rodas do chão durante o teste após ajuste do cinto
 - Todo o trabalho deve ser realizado com visibilidade suficiente e/ou iluminação adequada.
 - Use equipamento de proteção pessoal, conforme necessário.
6. Ao transportar a máquina:
- Desligue a máquina e retire a chave.
 - Peça assistência para levantar a máquina.
 - Use um guindaste ou macaco que suporte o peso da máquina.
 - Não role a máquina escada acima ou abaixo.
 - Utilize tiras de amarrar para proteger a máquina quando transportada por um veículo.

Informações sobre o carregador a bordo

O perfil de carregamento do carregador da bateria a bordo é especificamente configurado para uma bateria GEL de 12 V selada. Ao instalar uma bateria de substituição, é importante utilizar o mesmo tipo de bateria ou poderá haver dano à bateria e/ou ao carregador.

Para obter instruções operacionais do carregador da bateria, consulte o manual do carregador de bateria fornecido com a máquina.

Adesivo de segurança

O adesivo de segurança aparece na máquina no local indicado. Substitua o adesivo caso esteja faltando ou esteja danificado ou ilegível.

⚠ WARNING

TO REDUCE THE RISK OF FIRE, ELECTRIC SHOCK, OR INJURY: <ul style="list-style-type: none"> • Do Not Use Near Flammable Liquids, Vapors or Combustible Dusts. • Do Not Pick Up Flammable or Toxic Materials and Burning Debris. • Keep Sparks and Open Flame Away When Charging Batteries. • Disconnect Battery Cables and Charger Cord Before Servicing. • Do Not Charge Batteries With Damaged Cord. Do Not Modify Plug. • Do Not Use On Wet Surfaces. Store Indoors.
⚠ AVERTISSEMENT
POUR RÉDUIRE LES RISQUES D'INCENDIE, DE CHOC ÉLECTRIQUE OU DE BLESSURE: <ul style="list-style-type: none"> • N'utilisez Pas Près de Liquides, Vapeurs ou Poussières Inflammables. • Ne Ramassez Pas de Matériaux Inflammables ou Toxiques et de Déchets Enflammés. • Éloignez les Sources d'Étincelles ou de Flamme Ouverte Lors du Chargement des Batteries. • Débranchez les Câbles de Batterie et la Cordon du Chargeur Avant l'Entretien. • Ne Chargez Pas la Batterie Avec un Cordon Endommagé. Ne Modifiez Pas la Prise. • N'utilisez Pas Sur des Surfaces Humides. Entrez à l'Intérieur.
⚠ ADVERTENCIA
PARE REDUCIR EL RIESGO DE INCENDIO, CHOQUE ELÉCTRICO, O LESIONES: <ul style="list-style-type: none"> • No Use Cerca De Líquidos Flamables, Vapores Ó Materiales Combustibles. • No Recoja Materiales Flamables Ó Tóxicos Ni Desechos Candescentes. • Mantenga Chispas Y Fuego Alejados Mientras Carga Baterías. • Desconecte Cable De Bateria Y Cable Del Cargador Antes Del Mantenimiento. • No Cargue Baterías Con Cable Dañado. No Altere El Enchufe. • No Lo Utilice En Superficies Húmedas. Guarde Bajo Techo.
1071275



引言

本手册随每种新型号提供，它提供必要的操作、维护说明和更换部件信息。



使用本机器前请阅读所有说明

用途

本款电瓶供电手推自走式自动扫地机用于商业用途，例如建筑物、仓库、停车场和人行道。例如建筑物、仓库、停车场和人行道。它针对室内和室外应用设计，适合拾取干硬地面和地毯表面上的不易燃干燥粉尘和碎屑。它不适合湿表面或拾取易燃或危险物质。

常规信息

本机器性能优异。但是，只有在以下情况下才能以最低成本发挥最佳性能：

- 操作机器时谨慎小心。
- 按照提供的机器维护说明定期维护机器。
- 使用制造商提供的或同等部件维护机器。



保护环境



请按照当地废物处理法规以环保的方式处理包装材料 and 旧的机器组件。

始终记住尽量将物品回收利用。

技术规格

型号	S9
长度	1085 毫米 / 43 英寸
宽度	799 毫米 / 31 英寸
高度	658 毫米 / 26 英寸
重量	137 千克 / 300 磅
扫地宽度	900 毫米 / 35 英寸
主刷宽度	500 毫米 / 20 英寸
边刷直径	354 毫米 / 14 英寸
垃圾斗容量	60 升 / 15.9 夸脱
电瓶容量 12V	12 V, 105 Ah (C5) 120Ah (C20)
总功耗	12 VDC, 590 W, 34.3 A
电瓶充电器	100-240VAC 10A
最长运行时间	3 小时
清扫效率 (净)	3150 m ² /hr / 23620 ft ² /hr
最大斜坡	2%
手臂处的机器振动 *	<2.5m/s ²
机器振动不确定度 K *	0.8 m/s ²
声压级别 L _{pA} *	62 dBA
声音不确定度 K _{pA} *	3 dBA
声压级别 L _{WA} + 不确定度 K _{WA} *	81 dB(A)
防护等级	IPX3
工作温度	-15°C 对 40°C

* 按照 EN 60335-2-72 确定的值

坦能清洁系统设备(上海)有限公司

中国上海青浦漕盈路3777号1幢 201712

电话: 86 21 6922 5333

www.tennantco.com.cn

原稿说明。版权所有 © 2012 TENNANT Company.

保留所有权利。德国印刷。

规格和部件可能更改，恕不另行通知。

机器数据

请在安装时填写，供以后参考。

型号 - _____

序列号 - _____

安装日期 - _____

重要的安全说明

(妥善保存这些说明)

此符号警告可能导致严重人身伤害或死亡的危险和不安全做法。

警告：为了减少起火、爆炸、触电或受伤危险：

- 不要在靠近可燃液体、蒸气或易燃粉尘的地方使用。
- 本机器不配备防爆马达。马达在启动和工作期间会产生火花，如果在存在可燃蒸气/液体或易燃粉尘的区域使用机器，可能导致闪火或爆炸。
- 不要拾取可燃或有毒物质，以及正在燃烧的残渣。
- 电瓶会排放氢气。为电瓶充电时远离火花和明火。
- 请在通风良好的区域为电瓶充电。
- 在维修机器前断开电瓶电缆线和充电线。
- 不要用损坏的电源线为电瓶充电。不要改装插头。
- 不要在湿表面上使用。室内存放。

以下安全预防措施表明可能会发生对操作员或设备产生危险的情况。

出于安全考虑：

1. 在以下情况下，不要操作机器：

- 未经培训和授权。
- 未阅读并理解操作员手册。
- 不能在思想上和行动上遵守机器指南。
- 所在的区域太暗，以致无法看清控制装置或安全地操作机器。
- 如果不在正确的工作状态。
- 垃圾斗和/或过滤器不在原位。

2. 操作机器前：

- 确保所有安全设备就位并且正常工作。

3. 操作机器时：

- 仅按照手册中的说明使用。
- 不要拾取可能会缠住刷子的绳索、线丝、金属丝等物体。
- 立刻报告机器损坏或故障操作。
- 不要让机器无人看管或将机器停放在不平整的表面上。
- 不允许儿童在机器上或附近玩耍。
- 不要让儿童和未经授权的人员靠近使用中的机器。
- 在光滑表面上慢行。
- 不要在超过 2% 的斜坡上操作。
- 不要使用机器运送人员或物体。
- 在多灰环境中配戴面罩、护目镜和手套。
- 旋转刷。保持手离开。
- 搬抬装满的垃圾斗时要小心，避免腰背劳损。
- 清除垃圾斗中的尖锐物体时戴上厚手套。
- 如果刷子堵塞或机器发生故障，关闭机器电源。

4. 离开或维修机器前：

- 在水平表面上停放。
- 关闭机器电源并取下钥匙。

5. 维修机器时：

- 关闭机器电源并取下钥匙。
- 在维修机器前断开电瓶缆线和充电线缆。
- 处理电瓶或电瓶缆线时佩戴手套和护目镜。
- 避免接触电瓶酸液。
- 使用制造商提供的或批准的更换部件。
- 所有维修工作必须由合格维修人员执行。
- 避开移动部件。不要穿着宽松的衣服或佩戴首饰并扎紧长发。
- 不要用电动喷雾器喷洒或用水管冲洗机器的电气元件附近区域。
- 不要对机器做出任何不同于原始设计的修改。
- 调整驱动皮带后，驱动轮在测试期间离开地面。
- 所有工作必须在有足够可见度和/或适当照明的情况下完成。
- 根据需要穿戴个人防护设备。

6. 运输机器时：

- 关闭机器电源并取下钥匙。
- 提升机器时寻求帮助。
- 使用能够支撑机器重量的装载坡台。
- 不可使用轮子上下楼梯。
- 在使用车辆运输机器时应使用皮带固定机器。

内置电瓶充电器信息

内置电瓶充电器的充电特性专门针对 12V 密封式 GEL 电瓶配置。在安装更换电瓶时，务必使用相同的电瓶类型，否则可能损坏电瓶和/或充电器。

有关电瓶充电器的操作说明，请参阅机器随附的电瓶充电器手册。

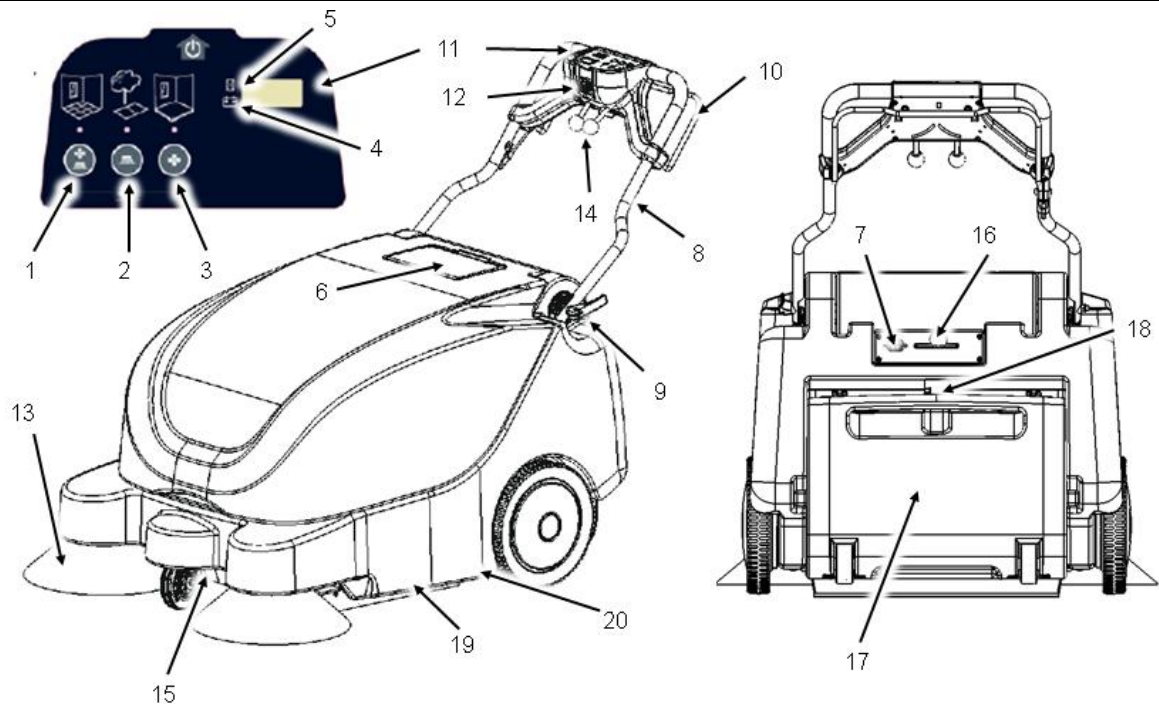

(EN) Machine Components

1. Vacuum, Side Brush, Main Brush Start Button
2. Side Brush, Main Brush Start Button
3. Vacuum, Main Brush Start Button
4. Battery Discharge Indicator
5. Hour Meter
6. Battery Charger Cord Storage Compartment
7. Battery Charger Outlet
8. Adjustable Control Handle
9. Adjustable Control Handle Lever
10. Drive Lever
11. Control Panel
12. Main Power Key Switch
13. Side Brush
14. Side Brush Lever
15. Internal Access Knob
16. Filter Shaker
17. Debris Hopper
18. Debris Hopper Release Lever
19. Dual Main Brushes
20. Anti-static Chain

(FR) Composants de la machine

1. Bouton d'activation de l'aspirateur, de la brosse latérale, de la brosse principale
2. Bouton d'activation de la brosse latérale, de la brosse principale
3. Bouton d'activation de l'aspirateur, de la brosse principale
4. Indicateur du niveau de charge des batteries
5. Compteur horaire
6. Compartiment de stockage du cordon du chargeur de batterie
7. Prise du chargeur de batterie
8. Poignée de commande réglable
9. Levier de poignée de commande réglable
10. Levier de commande
11. Tableau de bord
12. Bouton d'alimentation principale
13. Brosse latérale
14. Levier de la brosse latérale
15. L'accès interne
16. Secoueur de filtre
17. Bac à déchets
18. Levier Bac à déchets
19. Brosses latérales doubles
20. Chaîne antistatique

(CN) 机器组件

1. 真空吸尘器、边刷、主刷启动按钮
2. 边刷、主刷启动按钮
3. 真空吸尘器、主刷启动按钮
4. 电瓶放电指示器
5. 计时器
6. 电瓶充电器线缆存储舱
7. 电瓶充电器插座
8. 可调整的控制把手
9. 可调整的控制把手杆
10. 驱动杆
11. 控制面板
12. 总电源按钮
13. 边刷
14. 边刷杆
15. 内部访问旋钮
16. 过滤网振动器
17. 垃圾箱
18. 垃圾箱杆
19. 双主刷
20. 防静电链

(ES) Componentes de la máquina

1. Aspirador, cepillo lateral, botón de activación del cepillo principal
2. Cepillo lateral, botón de activación del cepillo principal
3. Aspirador, botón de activación del cepillo principal
4. Indicador de descarga de la batería
5. Contador de horas
6. Compartimento para guardar el cable del cargador de baterías
7. Enchufe del cargador de baterías
8. Manillar de control ajustable
9. Palanca del asa de control ajustable
10. Palanca de transmisión
11. Panel de control
12. Botón de encendido principal
13. Cepillo lateral
14. Palanca del cepillo lateral
15. El acceso interno
16. Sacudidor del filtro
17. Caja colectora
18. Caja colectora palanca
19. Cepillos principales dobles
20. Cadena anti-estática

(PT) Componentes da máquina

1. Botão de início do aspirador, escova lateral e escova principal
2. Botão de início da escova lateral e escova principal
3. Botão de início do aspirador e escova principal
4. Indicador de descarga de bateria
5. Contador de horas
6. Compartimento de armazenamento do cabo do carregador da bateria
7. Saída do carregador da bateria
8. Alças de controle ajustáveis
9. Alavanca das alças de controle ajustáveis
10. Alavanca de Locomoção
11. Painel de controle
12. Botão de energia principal
13. Escova lateral
14. Alavanca da escova lateral
15. acesso interno
16. Mecanismo de vibração do filtro
17. Contentor
18. Contentor alavanca
19. Escovas principais duplas
20. Cadeia anti-estática

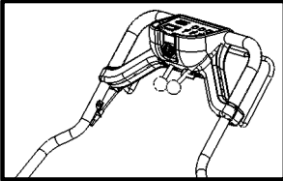
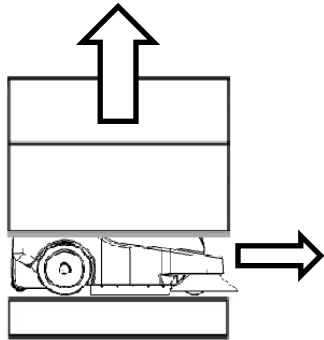
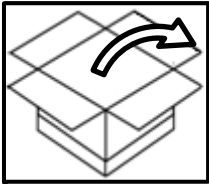

1

3

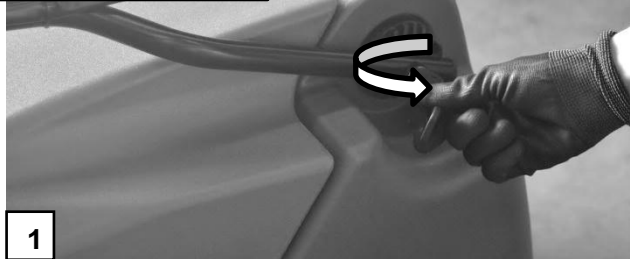

2



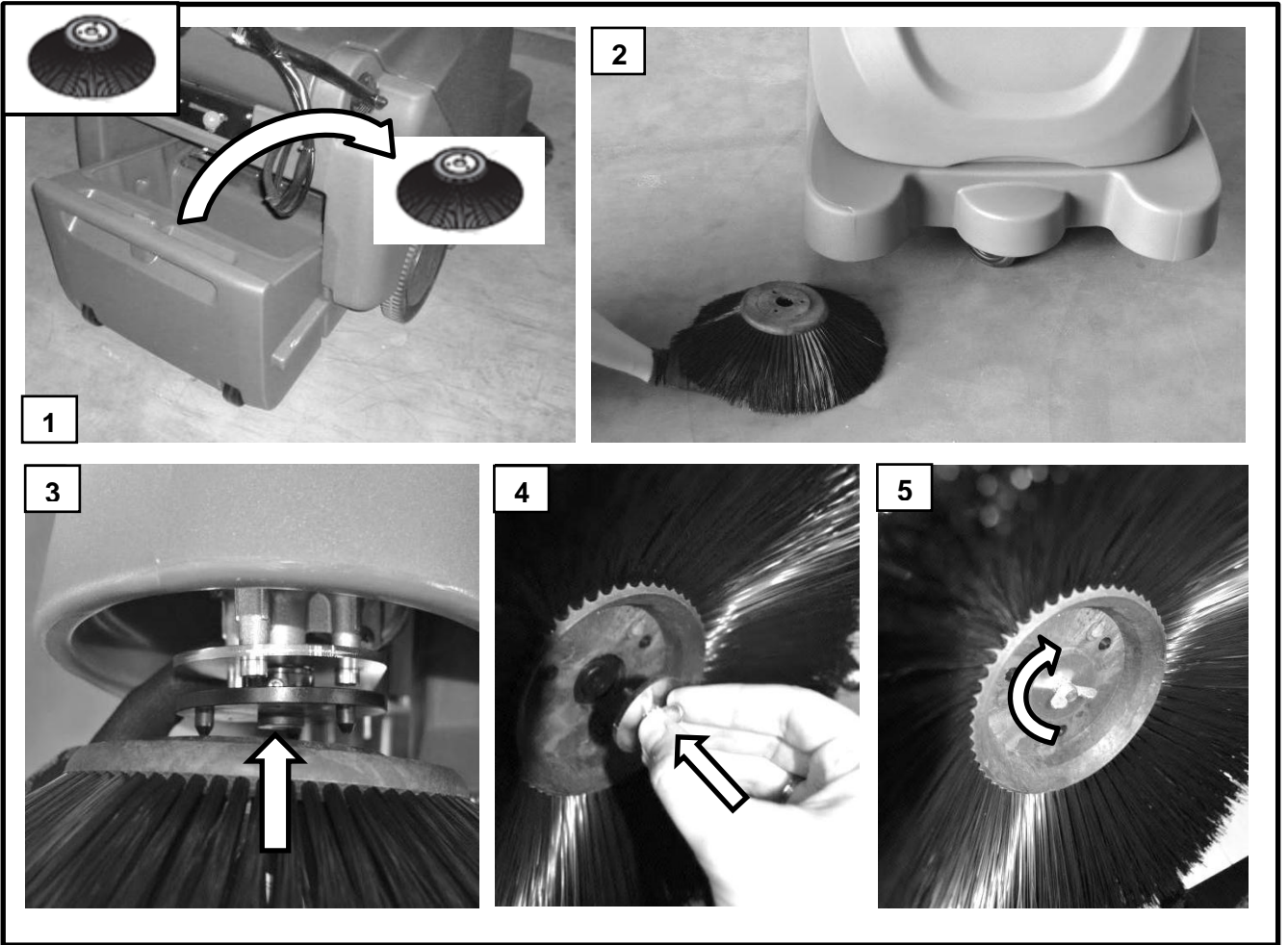

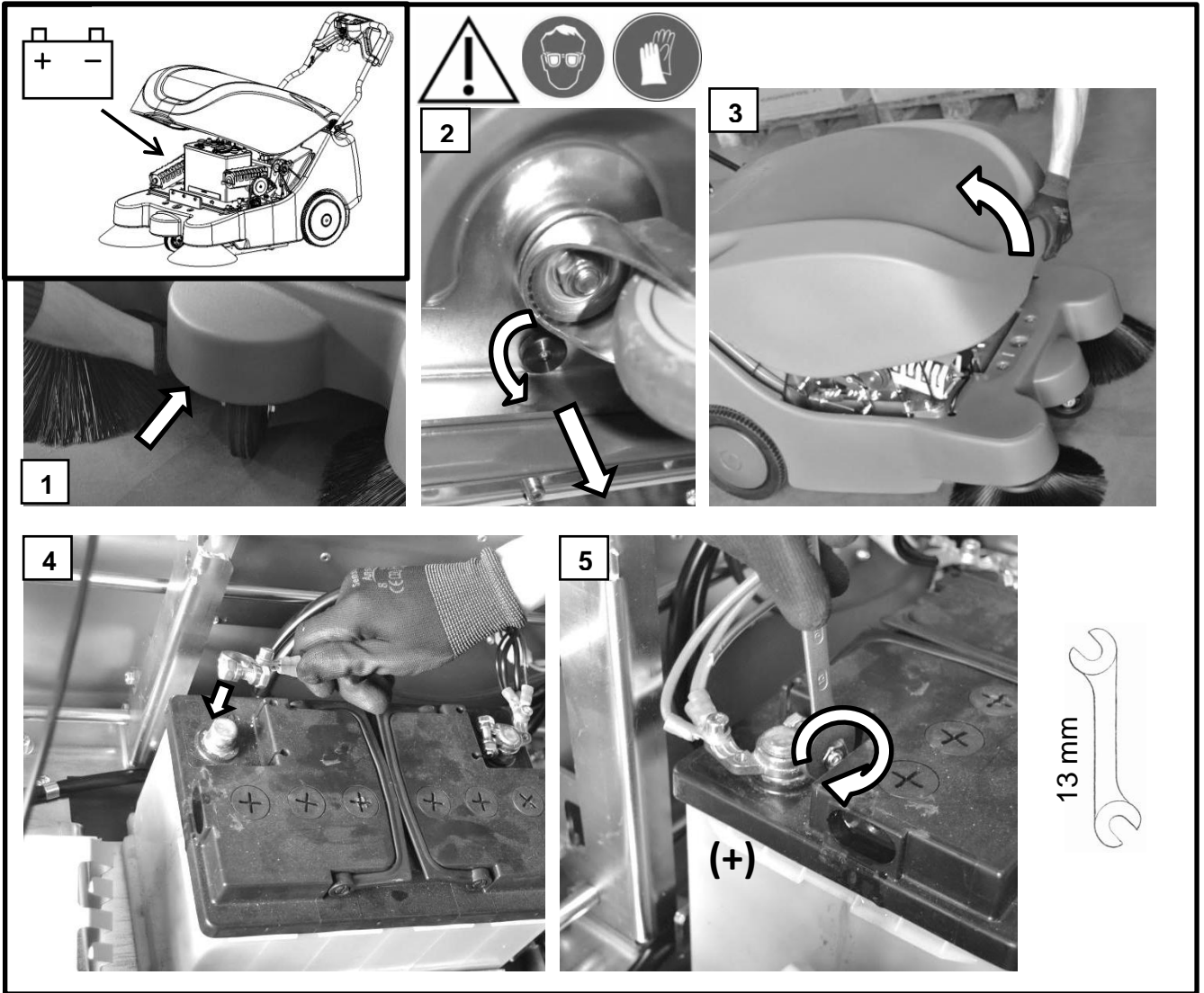

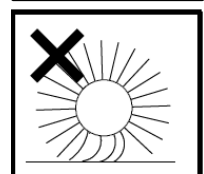
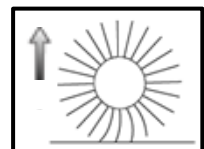
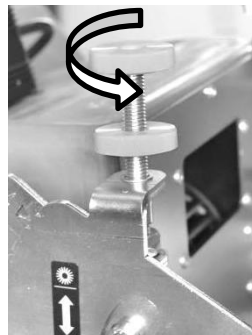
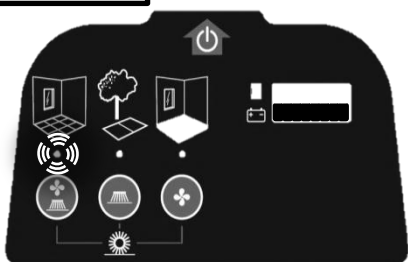
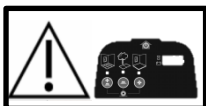
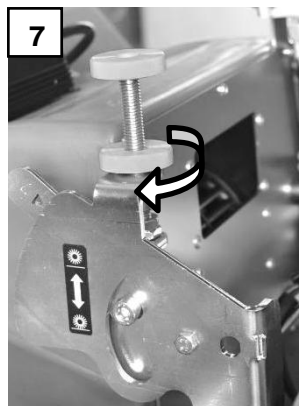
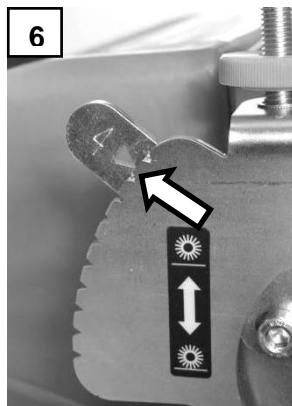
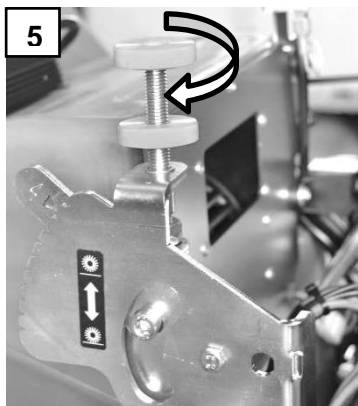
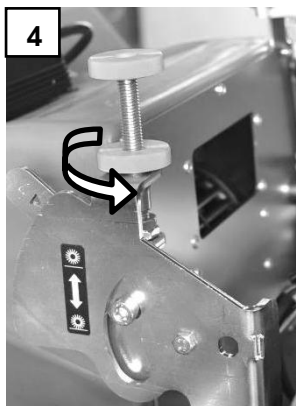
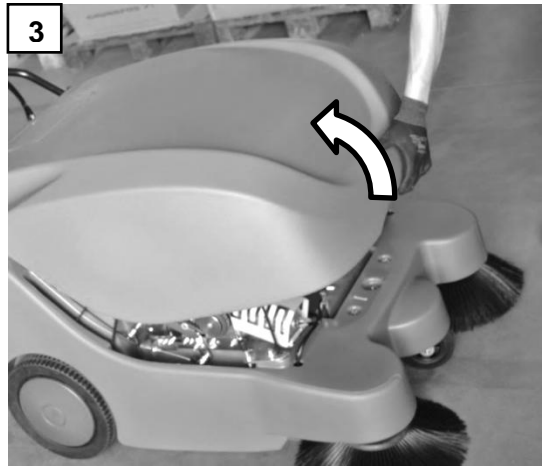
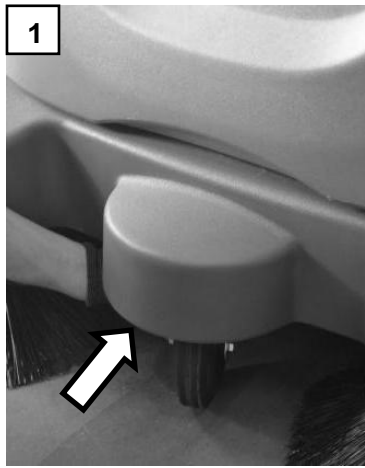
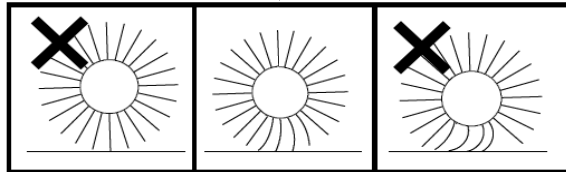
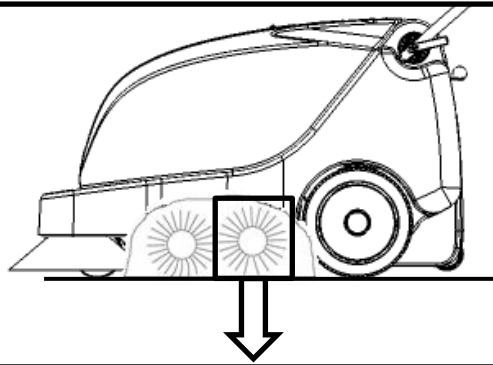
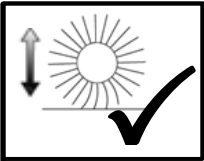

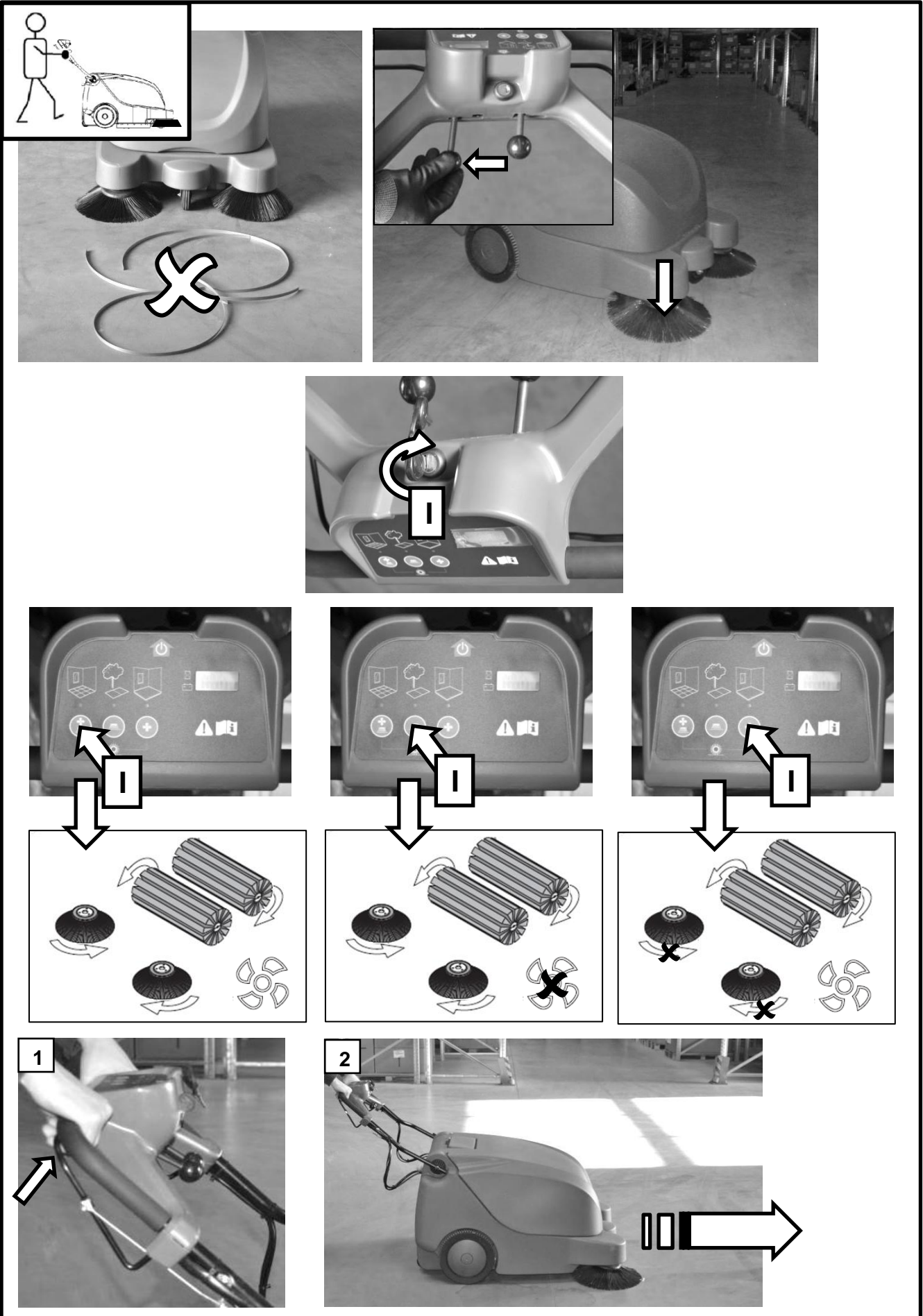

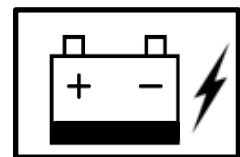
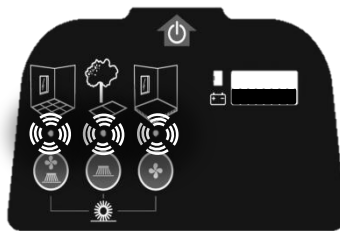
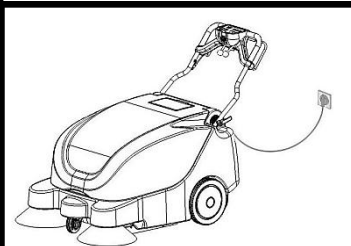
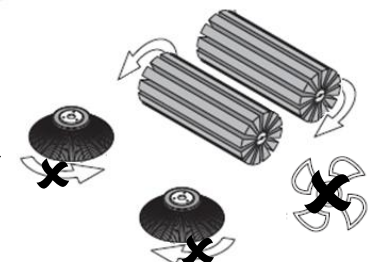
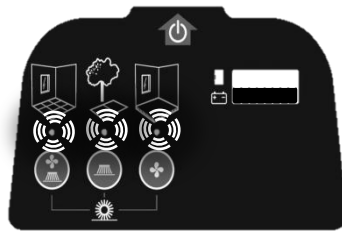
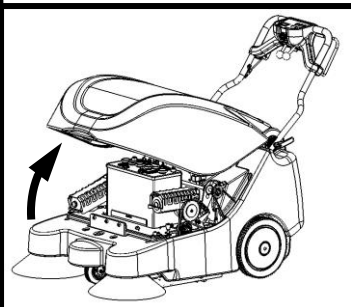
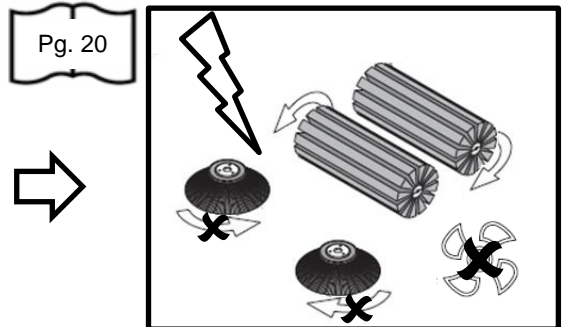
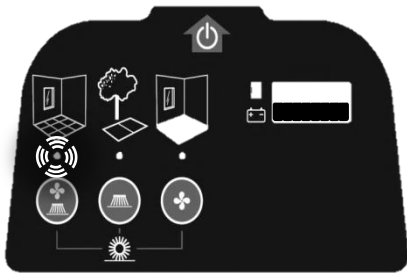
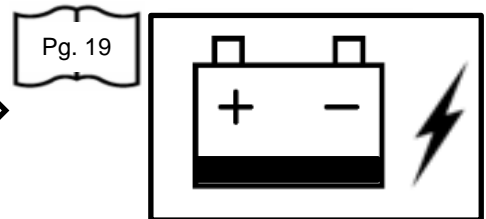
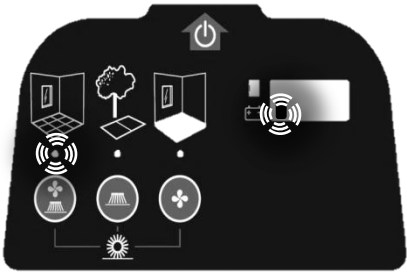
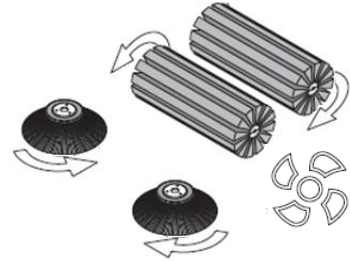
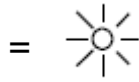
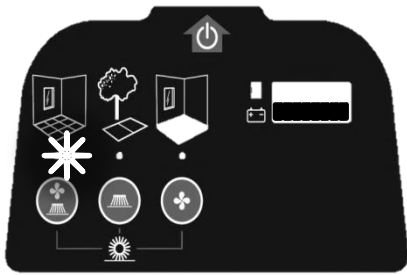
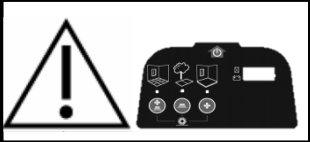

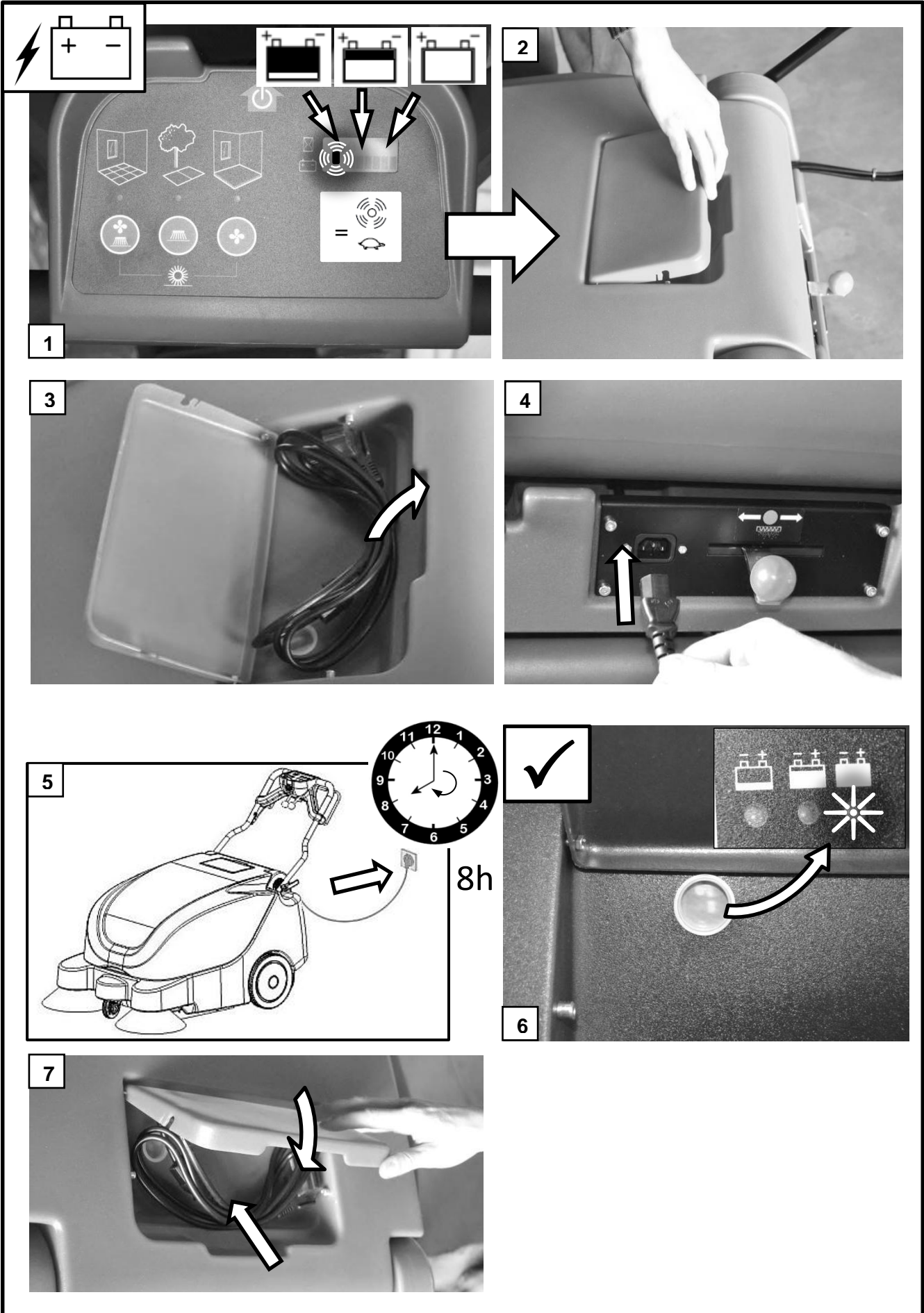

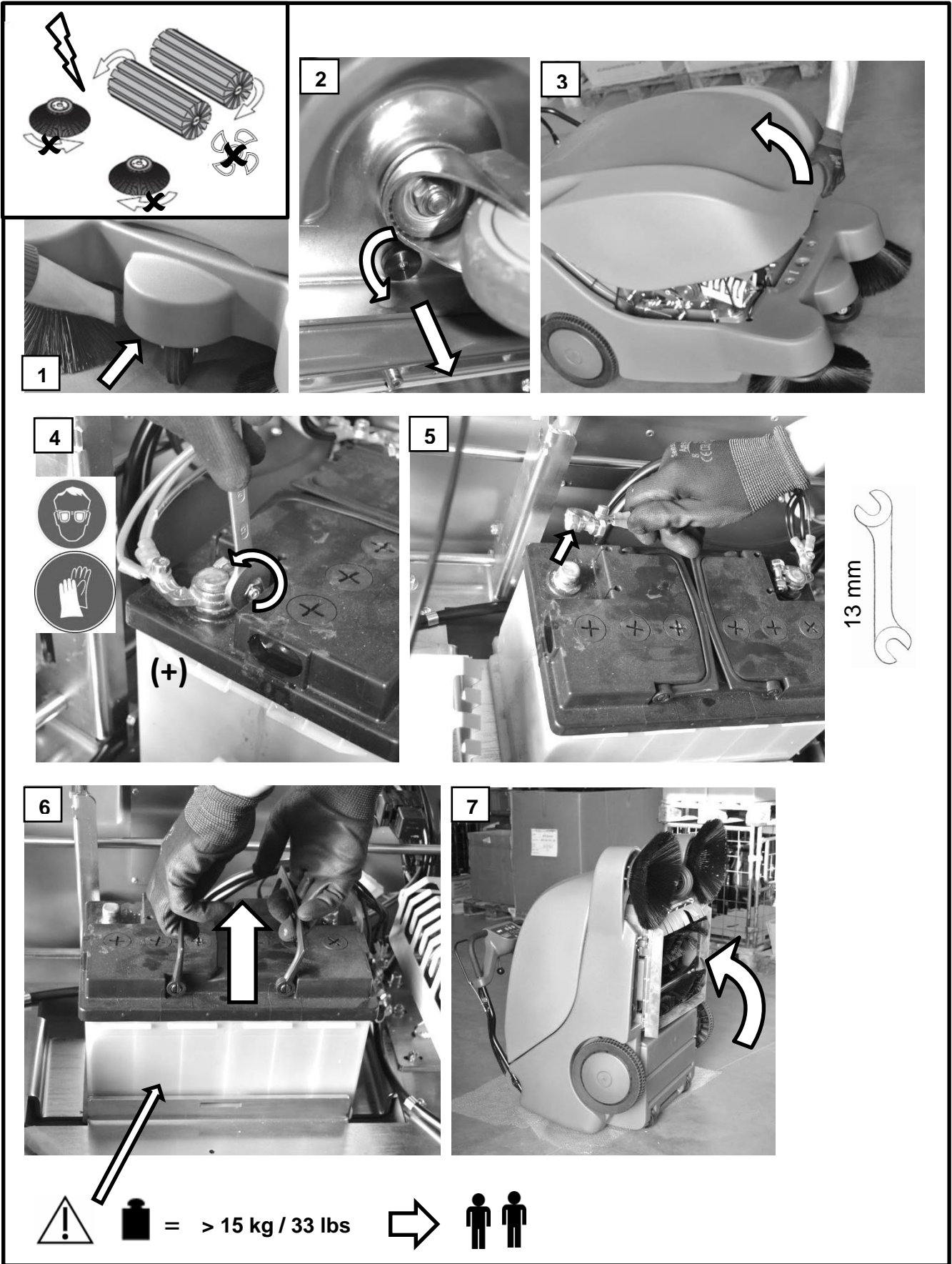

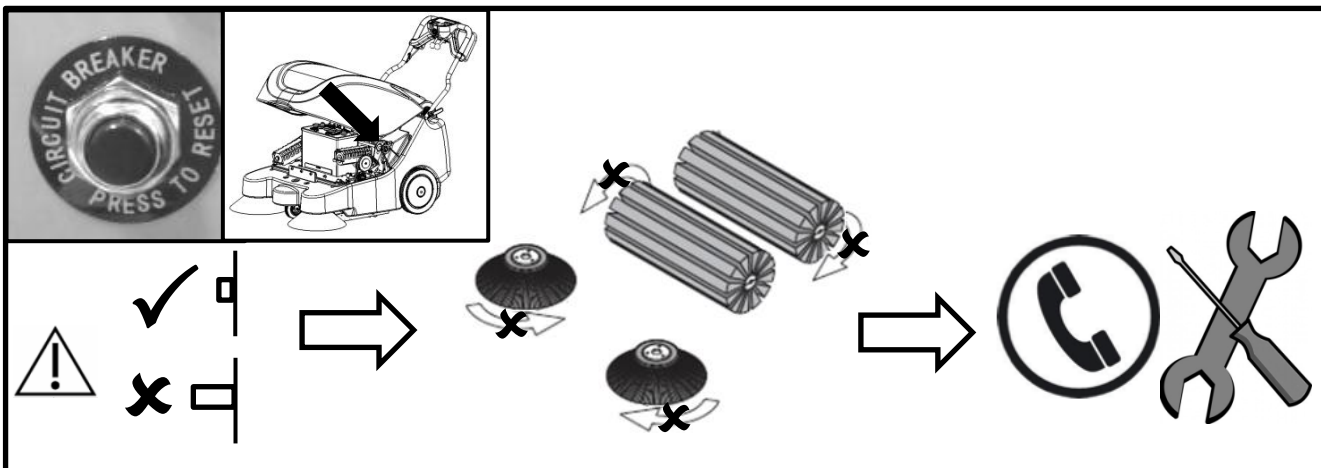
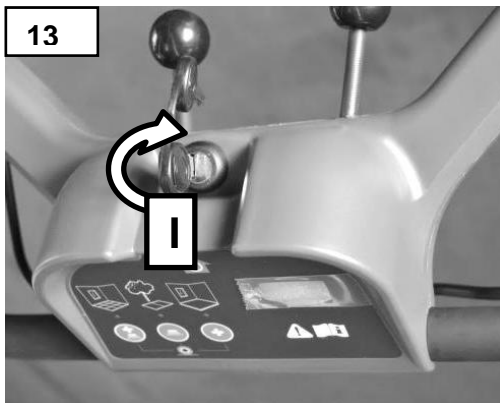
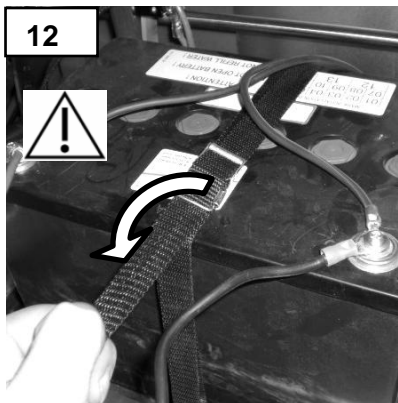
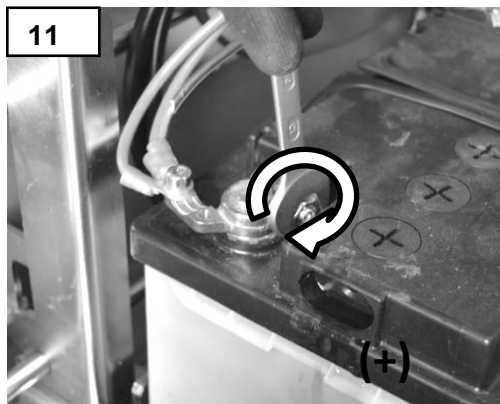
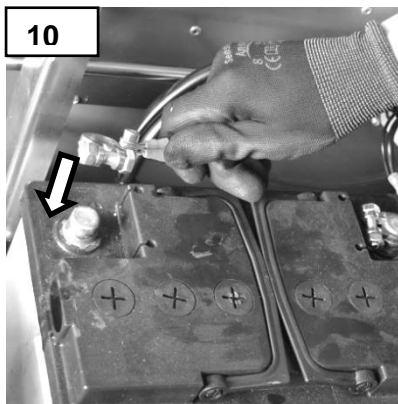
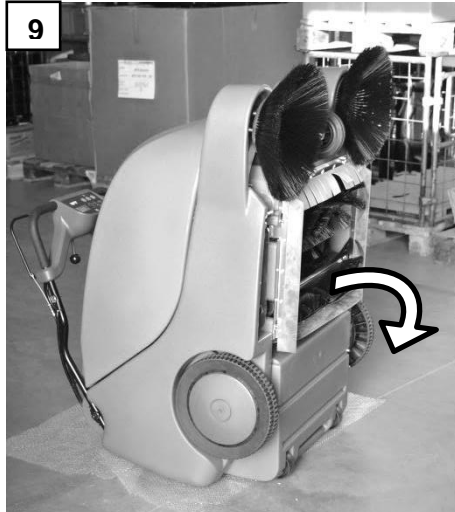
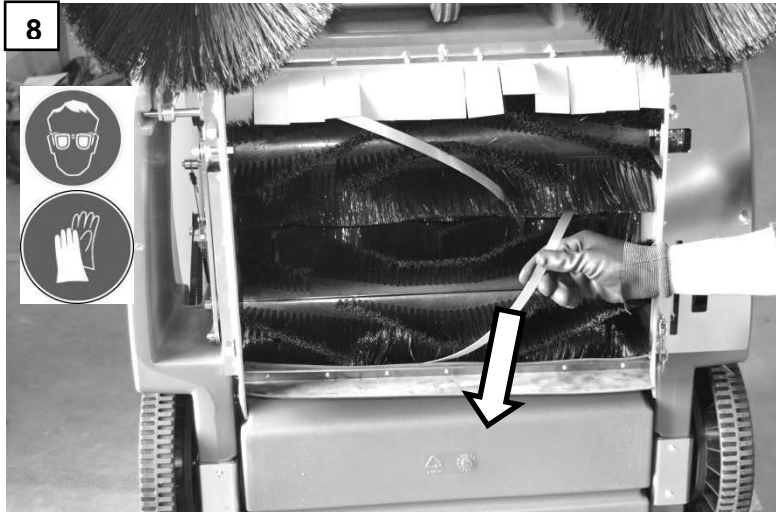

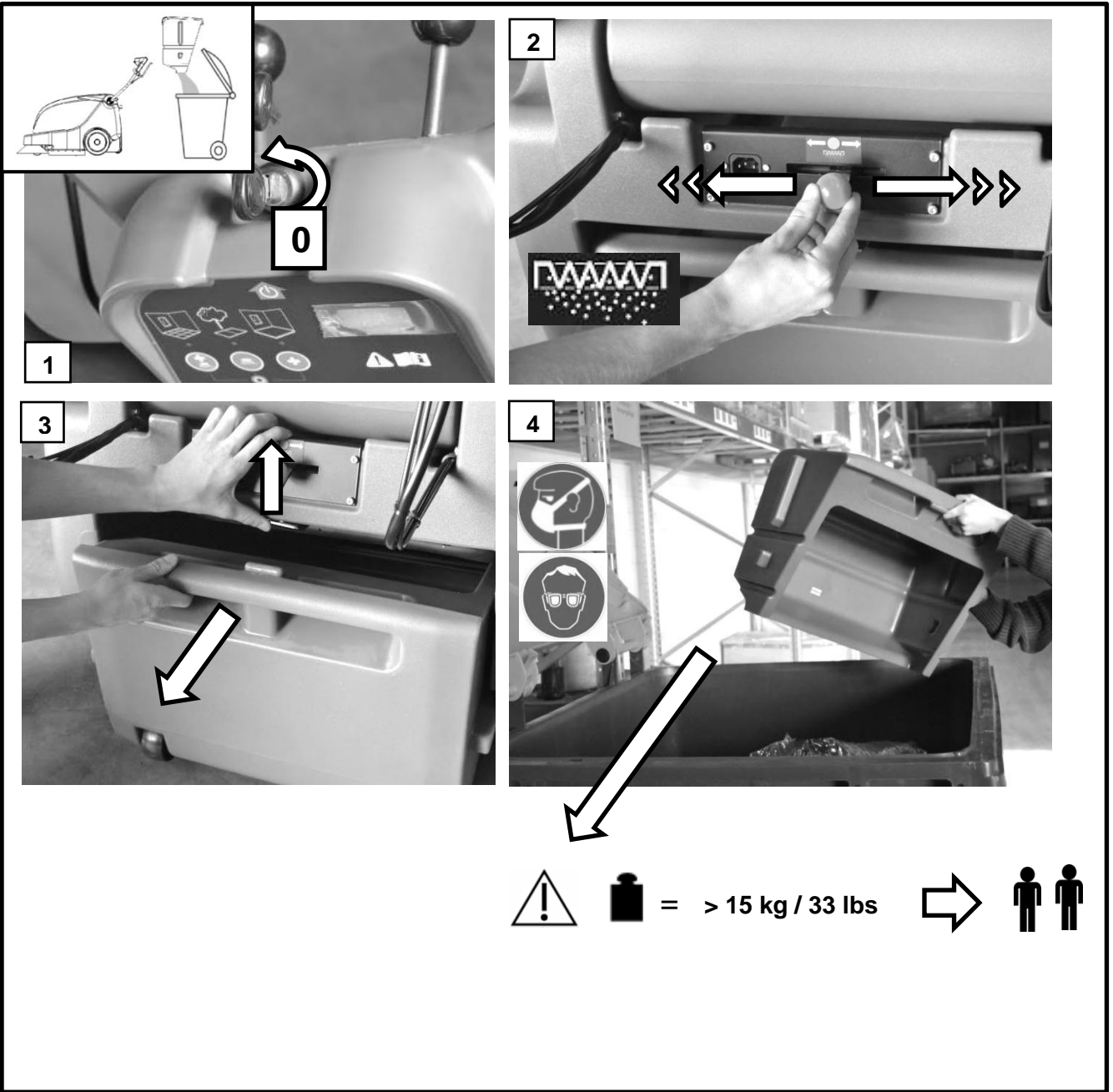
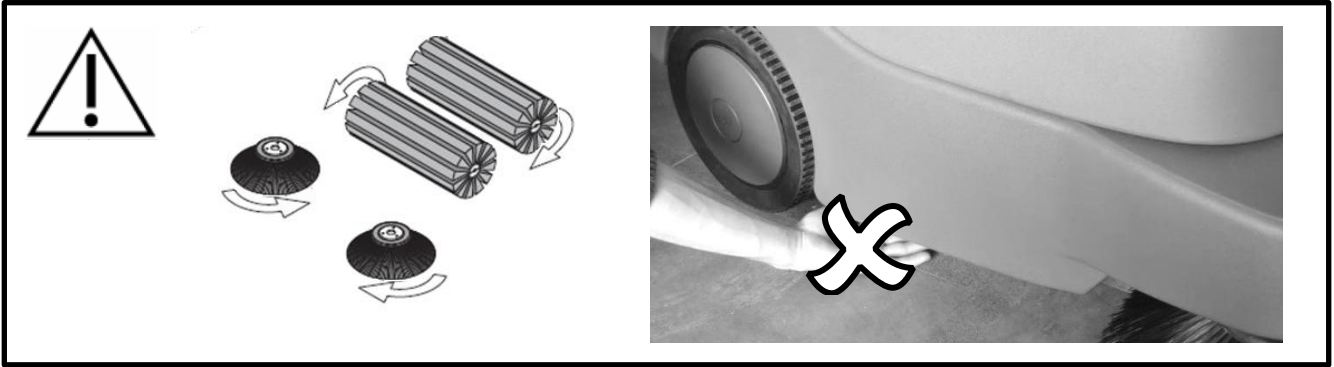

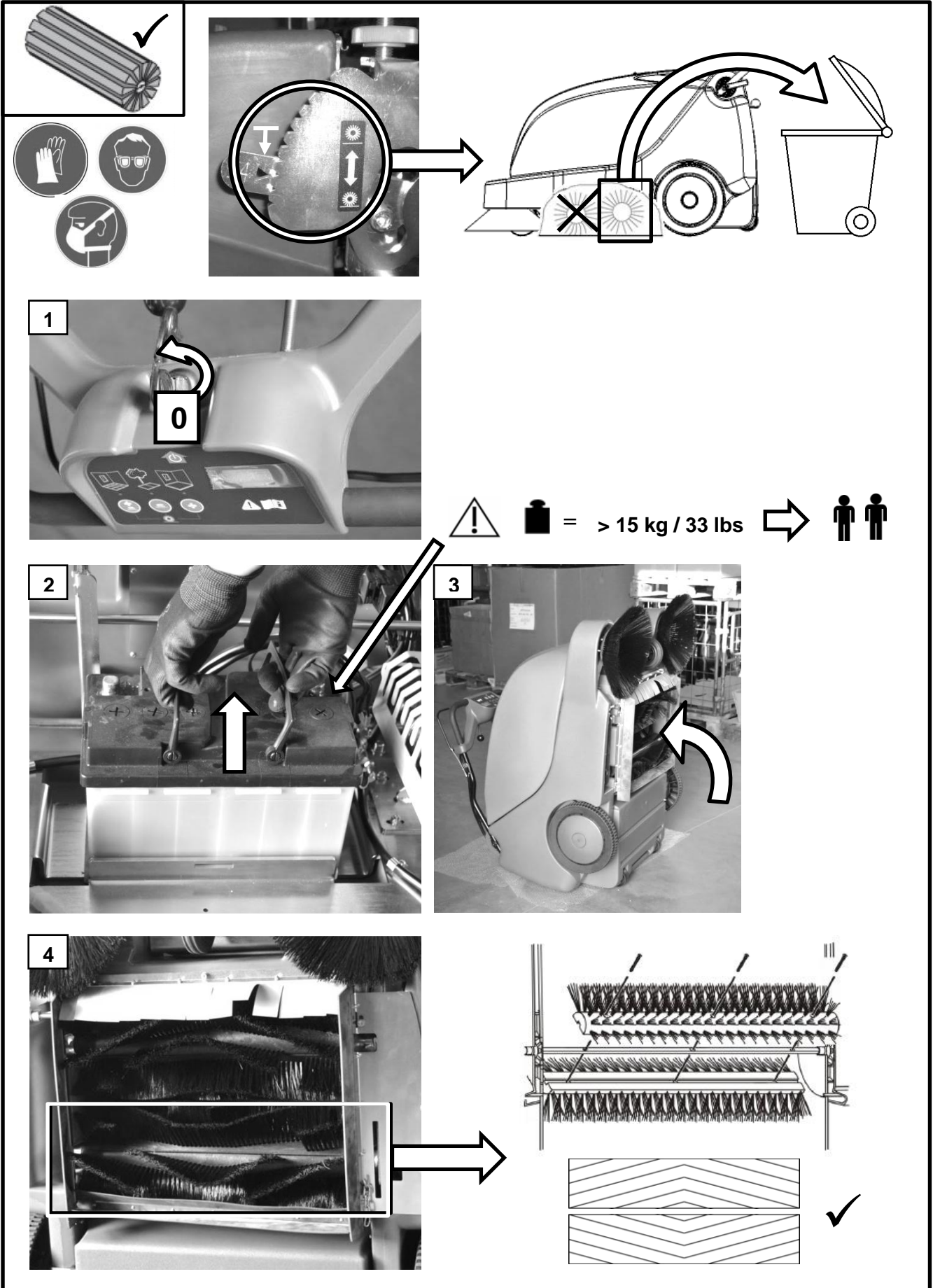

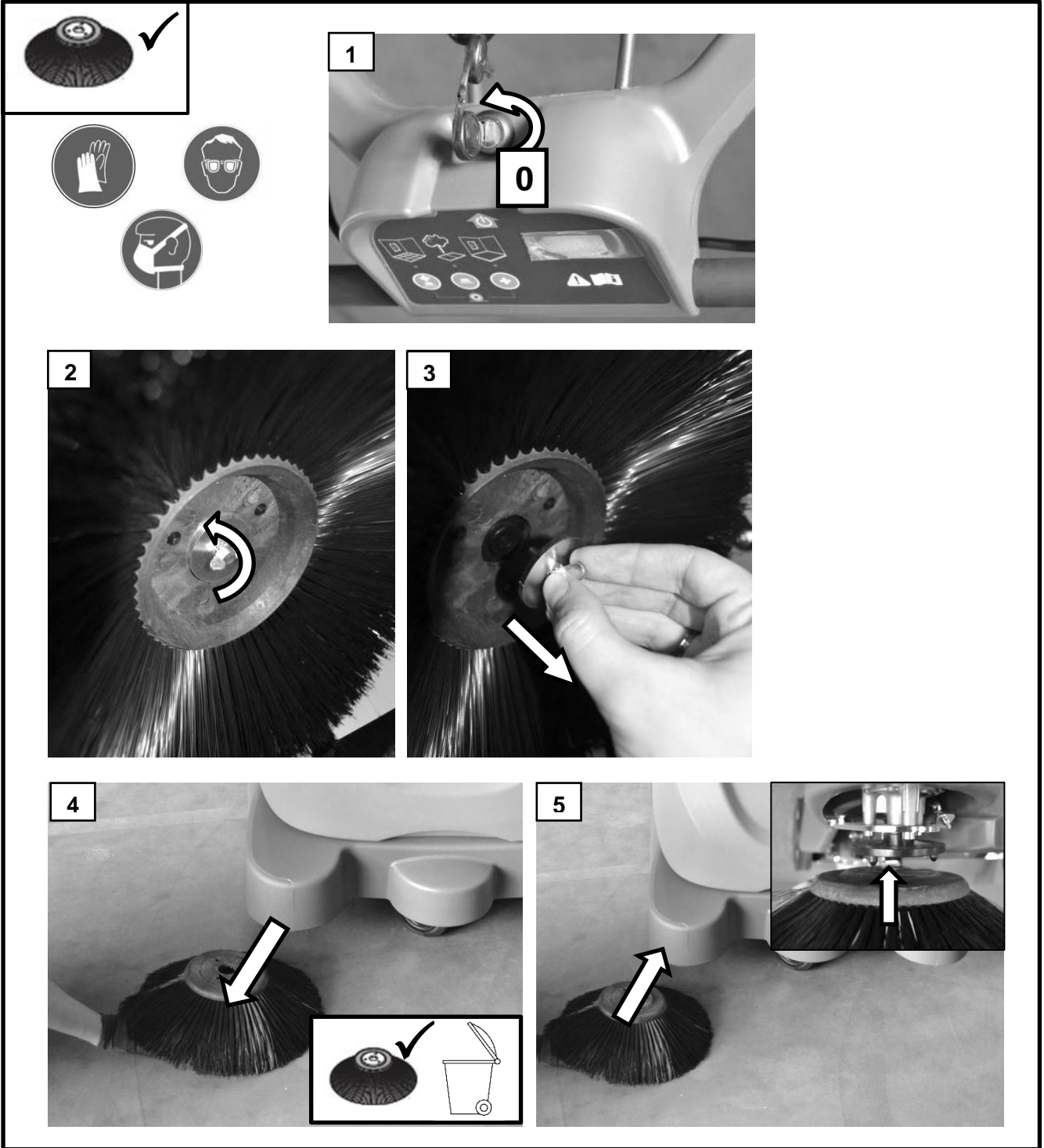

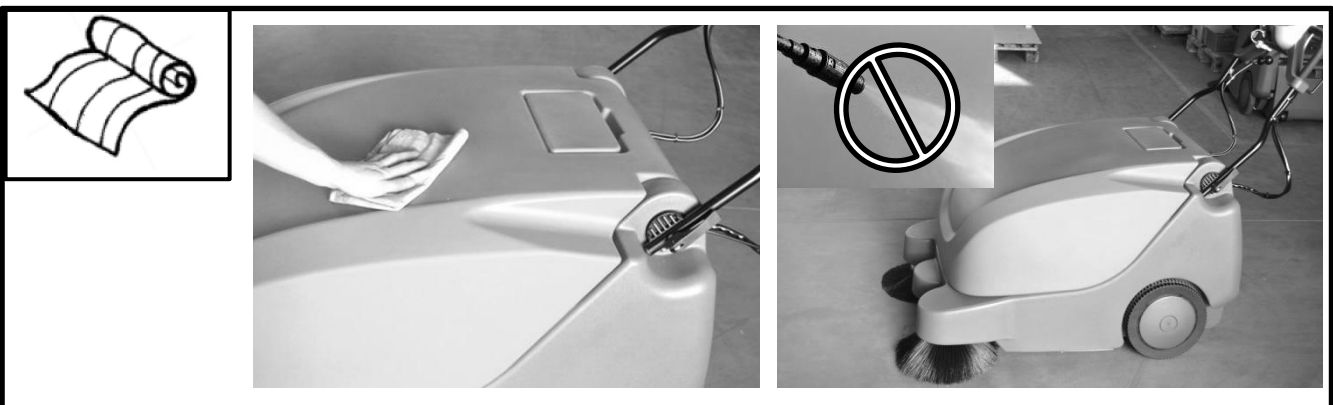
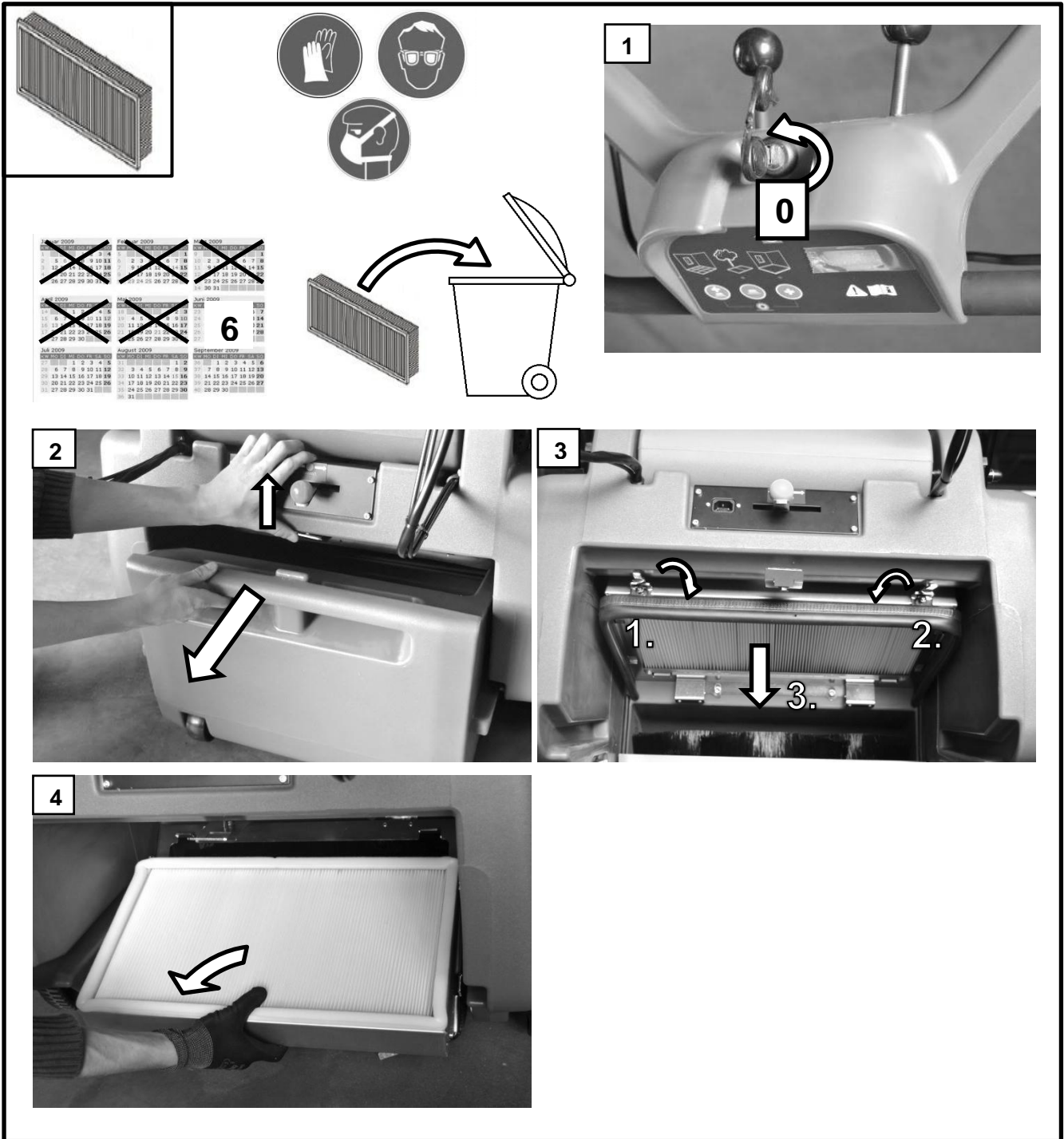

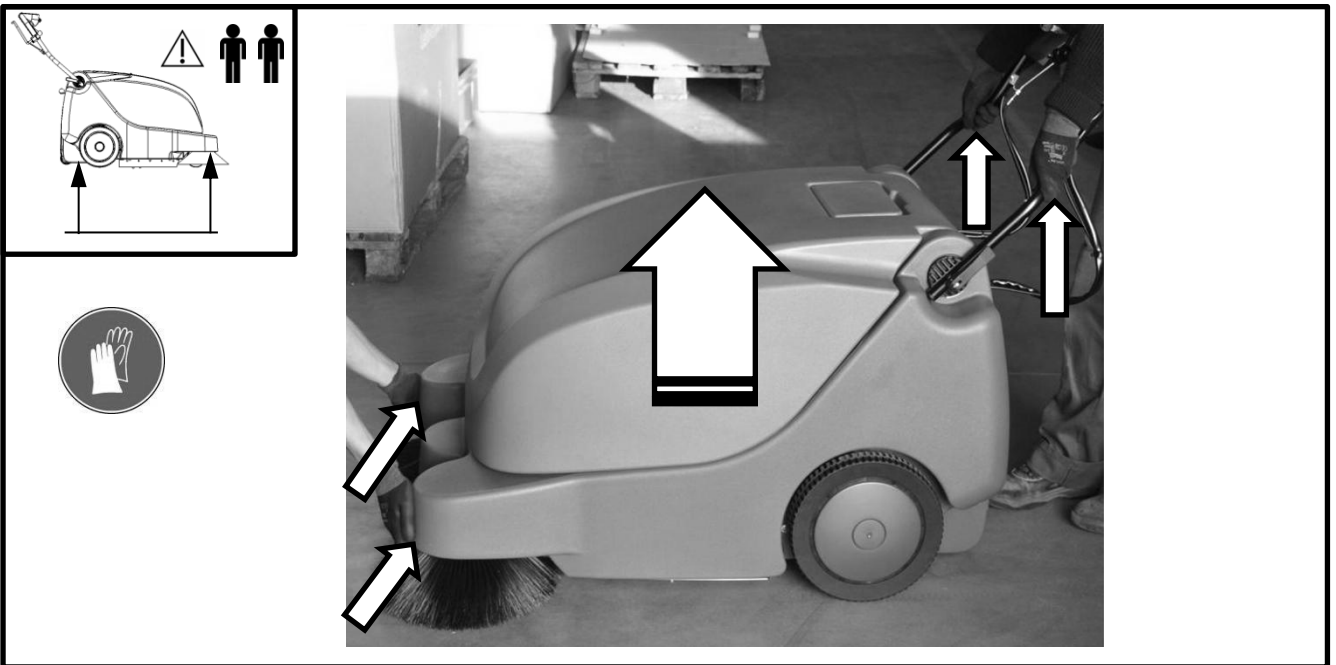
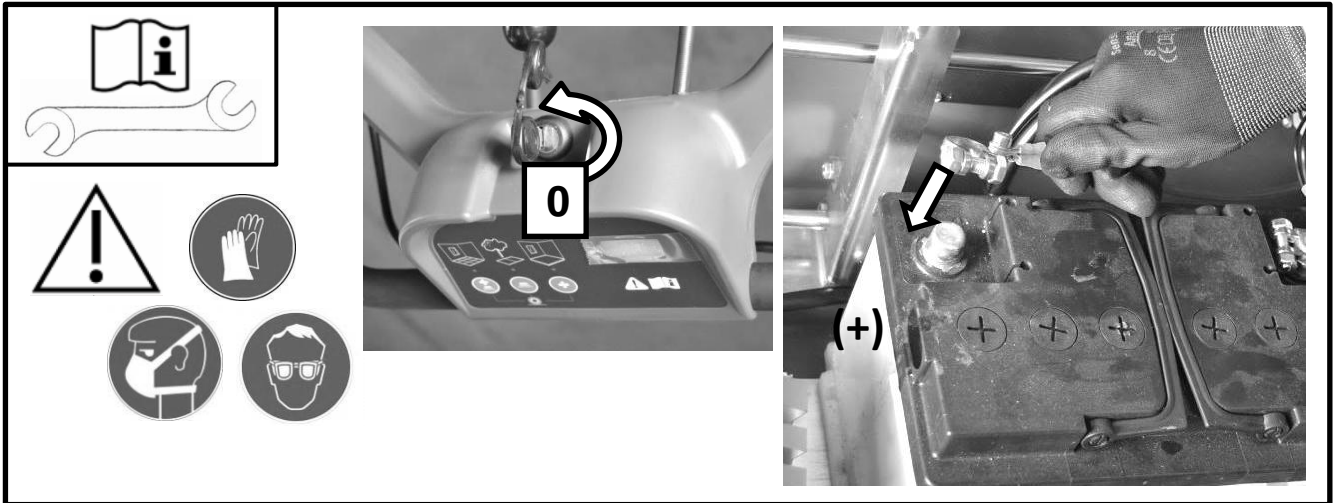

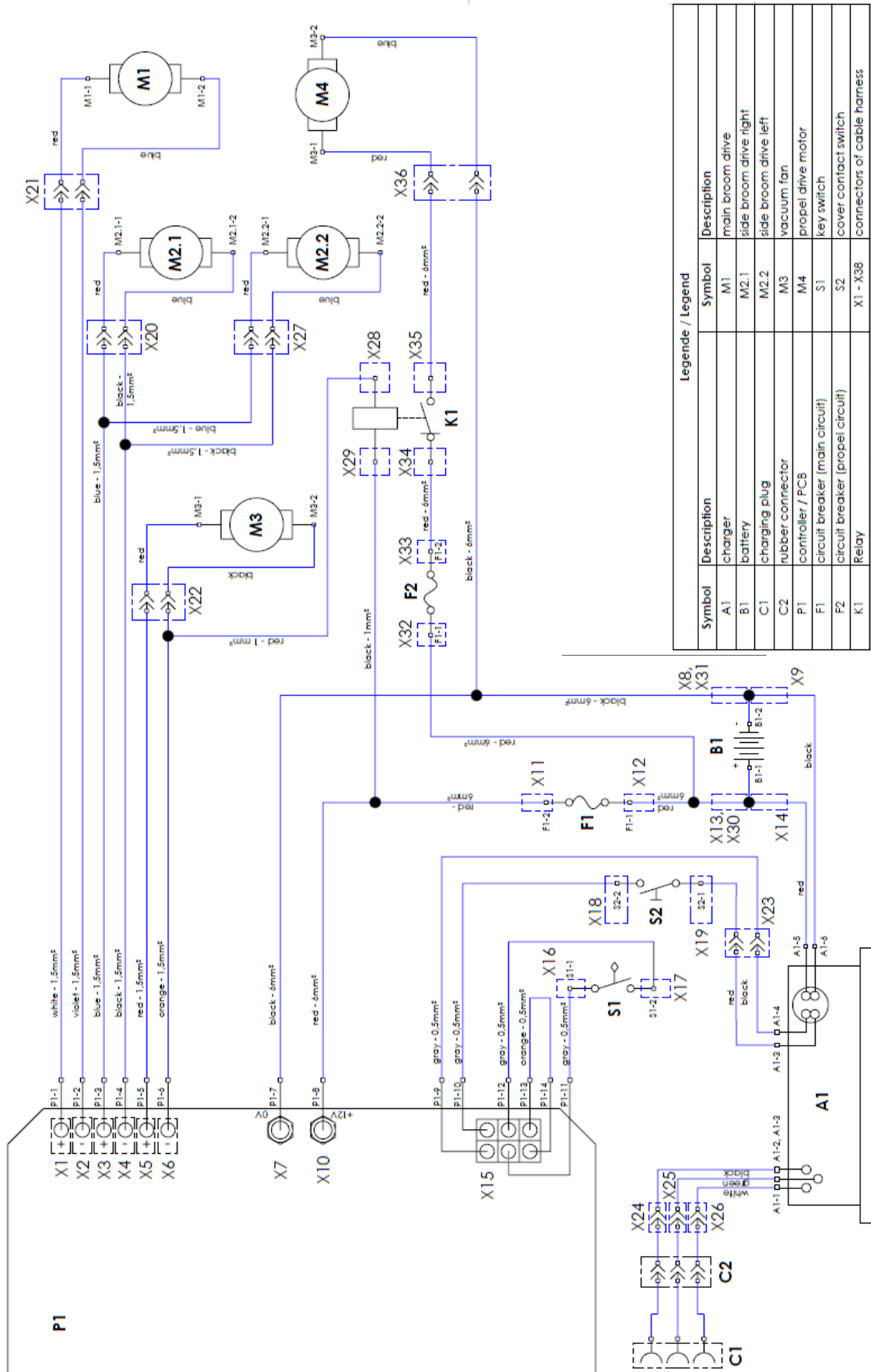

POWER EQUIPMENT			
Walk Behind Sweeper			
MODEL:	XX	POWER:	590 W
MATERIAL NO.:	XXXXXXX	VOLTAGE:	12 V
SERIAL NUMBER:	XX XXX XXX	CURRENT:	34.3 A
DC:	XXXX	WEIGHT-NET :	97 kg
PROTECTION:	IPX3	WEIGHT-	
		WITH BATTERY:	137 kg
		SOUND PRESSURE:	62 dB
			2%
TENNANT COMPANY 701 North Lilac Drive P.O. Box 1452 Minneapolis, MN 55440 USA 1-800-553-8033 www.tennantco.com			Made in Germany

Electrical Diagram



Legende / Legend	
Symbol	Description
A1	charger
B1	battery
C1	charging plug
C2	rubber connector
P1	controller / PCB
F1	circuit breaker (main circuit)
F2	circuit breaker (propel circuit)
K1	Relay
M1	main broom drive
M2.1	side broom drive right
M2.2	side broom drive left
M3	vacuum fan
M4	propel drive motor
S1	key switch
S2	cover contact switch
X1 - X38	connectors of cable harness

Fig. 1 – Wheel and Caster Assy

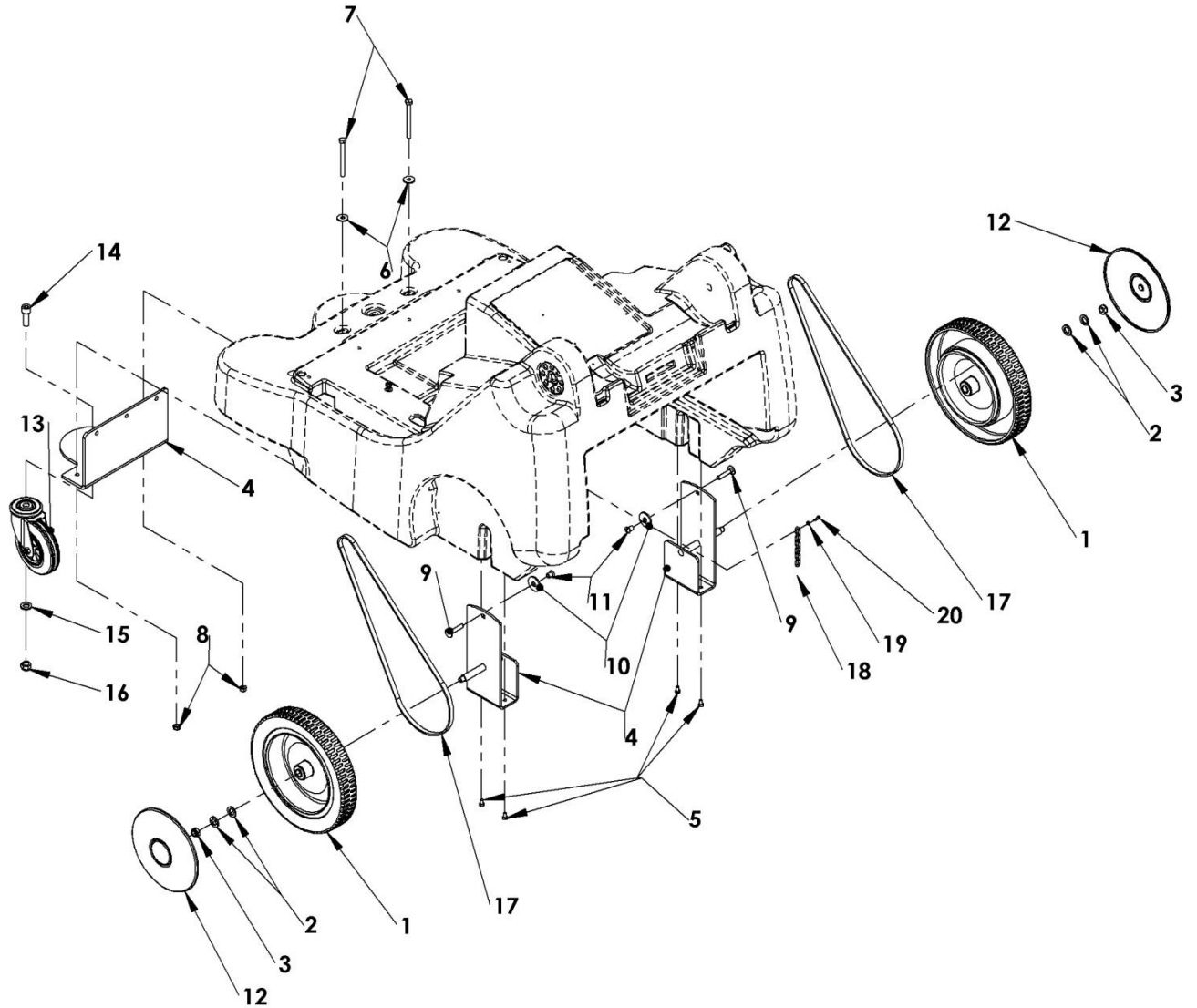

Fig. 1 – Wheel and Caster Assy

Ref.	Part No.	Description	Qty.
▽	1	9010055 ● Wheel Kit (Includes Wheel Qty 1, Bearings Qty 2 & Mounting Hardware	2
▲	2	N/A Washer, Flat, M14	4
▲	3	N/A Nut, Hex, Lock, M10	2
▽	4	9010080 Wheel MTG Kit (Includes Wheel bracket Qty 2, Caster Bracket Qty1 & Mounting Hardware)	1
▲	5	N/A Screw, Soc, M6x1x10	4
▲	6	N/A Washer, Flat, M8x20	2
▲	7	N/A Screw, Hex, M8x1.25x90	2
▲	8	N/A Nut, Hex, Lock, M8	2
▲	9	N/A Bolt Carriage M8x1.25x40	2
▲	10	N/A Washer, Flat 8.4x34x2.5	2
▲	11	N/A Sleeve Nut M8	2
	12	9010057 ● Hub Cap Kit Teal (Includes Hub Cap Teal Qty 2)	1
▽	13	9010059 ● Caster Kit (Includes Caster Qty 1 & Mounting Hardware)	1
▲	14	N/A Screw, Soc, M12x1.75x35	1
▲	15	N/A Washer, Flat, M12	1
▲	16	N/A Nut, Hex, Lock, M12	1
	17	9010076 ● Belt Kit Propel (Includes V-Belt Qty1 & Toothed Belt Qty2)	1
▽	18	9009647 ● Strap Kit, Static (Includes Static Strap & Mounting Hardware)	1
▲	19	N/A Washer, flat M4	1
▲	20	N/A Screw, Pan, 3.9x13 TCUT	1

▽ ASSEMBLY

▲ INCLUDED IN ASSEMBLY

● RECOMMENDED STOCK ITEM

N/A Not Available Separately. Local Purchase.

Fig. 2 – Wheel and Main Brush Drive

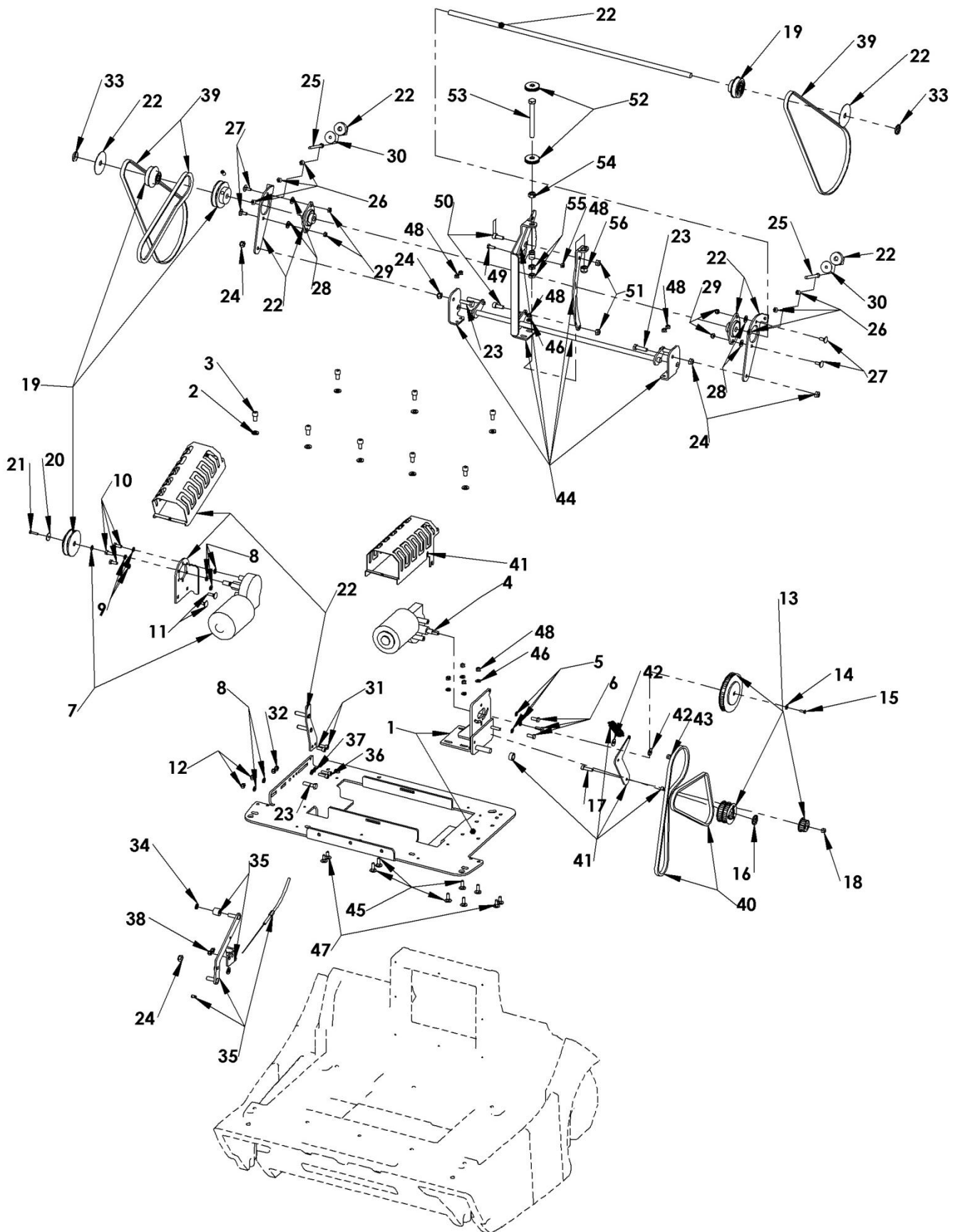

Fig. 2 – Wheel and Main Brush Drive

Ref.	Part No.	Description	Qty.	
▽	1	9010168	Bracket Kit Battery and Fan (Includes Battery Bracket Qty 1, Motor Bracket Qty 1, Fan Bracket Qty 1, Shaker Bracket Qty 1 & Mounting Hardware)	1
▲	2	N/A	Washer, flat, M8x17	8
▲	3	N/A	Screw, Soc, M8x1.25x16	8
▽	4	9010066 ●	Motor Kit Main Brush (Includes Main Brush Motor Qty1, Motor Guard Qty1 & Mounting Hardware)	1
▲	5	N/A	Washer, Lock, M6	3
▲	6	N/A	Screw, Lock, M6x1x16	3
▽	7	9010017 ●	Propel Motor Kit (Includes Propel Motor Qty 1, & Mounting Hardware)	1
▲	8	N/A	Washer, Flat, M6	5
▲	9	N/A	Washer, Lock, M6	3
▲	10	N/A	Screw, Hex, M6x1x16	3
▲	11	N/A	Bolt carriage M6x1x20	2
▲	12	N/A	Nut, Hex, Lock M6	2
▽	13	9010165	Pulley Kit, Main Brush(Includes Pulley Z60 Qty 1, Pulley Z20 Qty1, Double Pulley Z32 Qty1, Pulley Z32 Qty2, Bushing Qty1 & Mounting Hardware)	1
▲	14	N/A	Washer, Flat, M4	1
▲	15	N/A	Screw, Hex, M4x0.7x12	1
▲	16	N/A	Retainment Ring 12	1
▲	17	N/A	Screw, Soc, M6x1x24	1
▲	18	N/A	Nut, Hex, Lock M6	1
▽	19	9010178	Pulley Kit Propel (Includes Motor Pulley Qty1, Pulley Qty1, Pulley Z32 lh Qty1, Pulley Z32 rh Qty1, Washer d60 Qty2 & Mounting Hardware)	1
▲	20	N/A	Washer, Flat, M4x20	1
▲	21	N/A	Screw, Hex, M4x0.7x20	1
▽	22	9010179	Propel Tensioning Kit (Includes Drive Shaft Qty1, Bracket lh Qty1, Bracket rh Qty1, Bearings Qty2, Clutch Lever Qty1, Motor Bracket Qty1, Motor Guard Qty1, Bushing Qty2, Washer D=60 Qty2 & Mounting Hardware)	1
▲	23	N/A	Screw, Hex, M8x1.25x30	3
▲	24	N/A	Nut, Hex, Lock M8	5
▲	25	N/A	Screw, Hex, M6x1x65	2
▲	26	N/A	Nut, Hex, Std M6	6
▲	27	N/A	Bolt carriage M6x1x16	4
▲	28	N/A	Washer, Flat, M8	4
▲	29	N/A	Nut, Hex, Lock M6	4
▲	30	N/A	Washer, Flat, M6x30	2
▲	31	N/A	Screw, Soc, M6x1x16	2
▲	32	N/A	Nut, Hex, Lock M6	2
▲	33	N/A	Retainment Ring 12	2
▲	34	N/A	Retainment Ring 8	1
▽	35	9010175 ●	Propel Bail and Cable (Includes Bail Qty1, Clutch Cable Qty1, Cable Bracket Qty2 & Mounting Hardware)	1
▲	36	N/A	Screw, Soc, M6x1x20	2
▲	37	N/A	Washer, Flat, M6	2
▲	38	N/A	Nut, Hex, Lock M6	2

▽ ASSEMBLY

▲ INCLUDED IN ASSEMBLY

● RECOMMENDED STOCK ITEM

N/A Not Available Separately. Local Purchase.

Fig. 2 – Wheel and Main Brush Drive

Ref.	Part No.	Description	Qty.
	39	9010076 ● Belt Kit Propel (Includes V-Belt Qty1, Timing Belt Qty2)	1
	40	9010078 ● Belt Kit Main Brush (Includes Double Timing Belt Qty 1 & Timing Belt Qty1)	1
▽	41	9010166 Tensioning Arm Kit, Main Brush (Includes Lever Qty 1, Motor Guard Qty1, Spring Qty 1 & Mounting Hardware)	1
▲	42	N/A Washer, Flat, M6x20	2
▲	43	N/A Nut, Hex, Lock M6	1
▽	44	9010167 Adjuster Kit Rear Brush (Includes Axle Qty1, Adjuster Bracket Qty1, Lever Qty1, Pointer Qty1, Fixing Bracket lh Qty1, Fixing Bracket rh Qty1, Flange Bracket Qty2, Lever Qty2 & Mounting Hardware)	1
▲	45	N/A Bolt carriage M6x1x20	6
▲	46	N/A Washer, Flat, M6	6
▲	47	N/A Bolt carriage M6x1x16	4
▲	48	N/A Nut, Hex, Lock, M6	9
▲	49	N/A Screw, Hex, M6x1x16	1
▲	50	N/A Screw, Soc, M8x1.25x20	2
▲	51	N/A Nut, Hex, Lock, M8	2
▽	52	9010011 ● Knob Kit (Includes Black Balls M8 Qty 2, Yellow Balls M8 Qty 1, Knurled Knob M10 Qty 2, Knurled Knob M6 Qty 1 & Mounting Material)	1
▲	53	N/A Screw, Hex, M10x1.5x100	1
▲	54	N/A Nut, Hex, Std, M10	1
▲	55	N/A Nut, Hex Jam, M10	2
▲	56	N/A Nut, Hex , Lock, M10	1

▽ ASSEMBLY

▲ INCLUDED IN ASSEMBLY

● RECOMMENDED STOCK ITEM

N/A Not Available Separately. Local Purchase.

Fig. 3 – Main Brush Assy

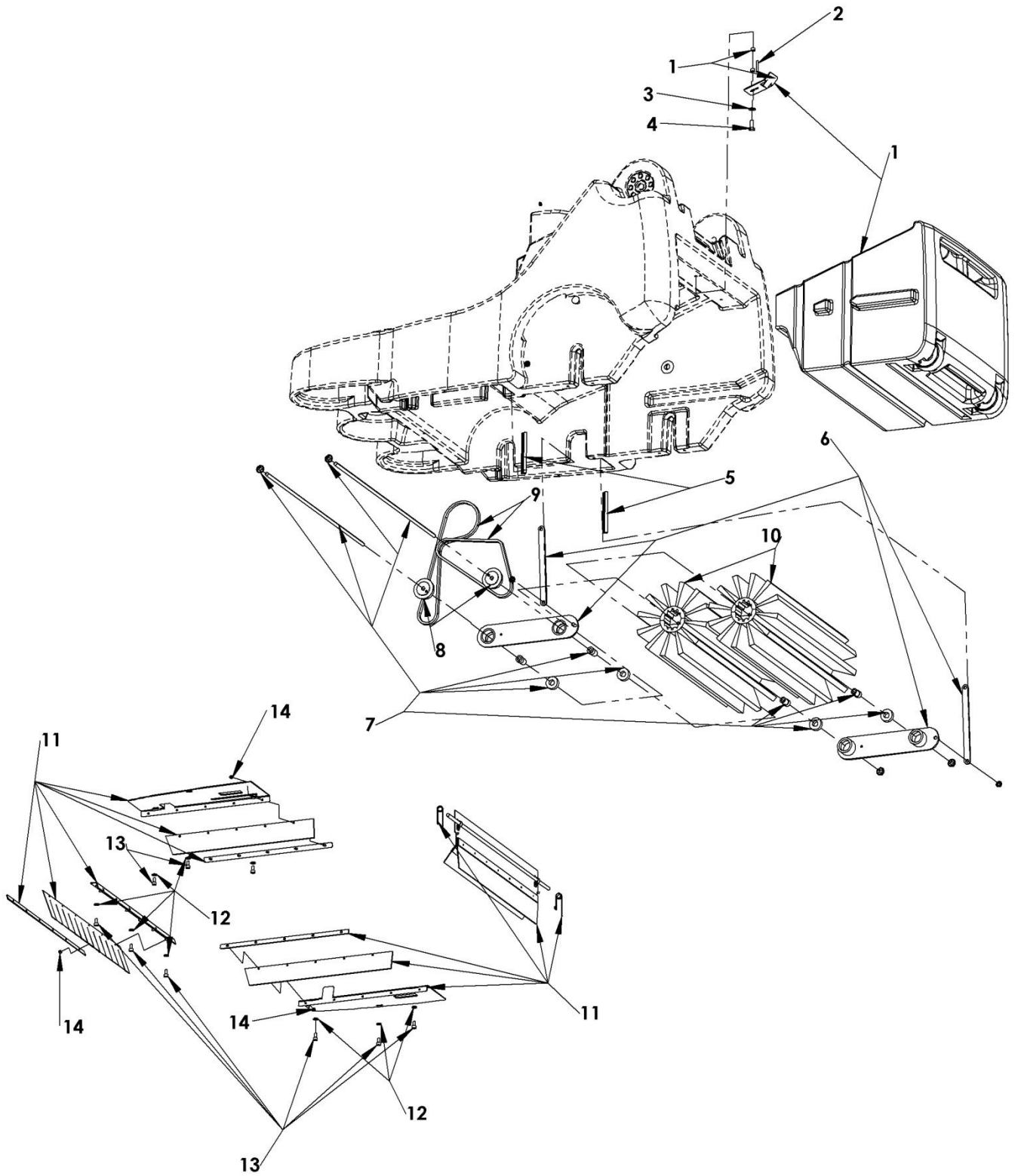

Fig. 3 – Main Brush Assy

Ref.	Part No.	Description	Qty.	
▽	1	9010031	Hopper Kit (Includes Hopper Qty1, Wheels Qty2, Closing Bracket Qty1, Bushings Qty2 & Mounting Hardware)	1
▲	2	N/A	Spiral Pin 8x30	1
▲	3	N/A	Washer, Flat, M8	1
▲	4	N/A	Screw, Hex, M8x1.25x20	1
▲	5	9010043 ●	Hopper Seal Kit (Includes Hopper Seal Qty2)	1
	6	9010167	Adjuster Kit Rear Brush (Includes Axle Qty1, Adjuster Bracket Qty1, Lever Qty1, Pointer Qty1, Fixing Bracket lh Qty1, Fixing Bracket rh Qty1, Flange Bracket Qty2, Lever Qty2 & Mounting Hardware)	1
	7	9010176	Main Broom Axle Kit (Includes Axle Qty2, Bearing Qty4, Bearing Support Qty4 & Retainment Rings Qty4)	1
	8	9010165	Pulley Kit, Main Brush (Includes Pulley Z60 Qty 1, Pulley Z20 Qty1, Double Pulley Z32 Qty1, Pulley Z32 Qty2, Bushing Qty1 & Mounting Hardware)	1
	9	9010078 ●	Belt Kit Main Brush (Includes Double Timing Belt Qty 1 & Timing Belt Qty1)	1
	10	9010036 ●	Brush Kit (Includes Main Brush Halves Qty 2 & Mounting Hardware)	2
▽	11	9010038 ●	Brush Flap Kit (Includes Flaps Side Qty2, Front and Rear Qty2, Brackets Qty9, Axle Qty1, Spring Qty2, Clamp Qty2 & Mounting Hardware)	1
▲	12	N/A	Washer, Flat, M6	9
▲	13	N/A	Screw, Soc, M6x1x12	9
▲	14	N/A	Nut, Hex, Lock, M4	16

▽ ASSEMBLY

▲ INCLUDED IN ASSEMBLY

● RECOMMENDED STOCK ITEM

N/A Not Available Separately. Local Purchase.

Fig. 4 – Side Brush Assy

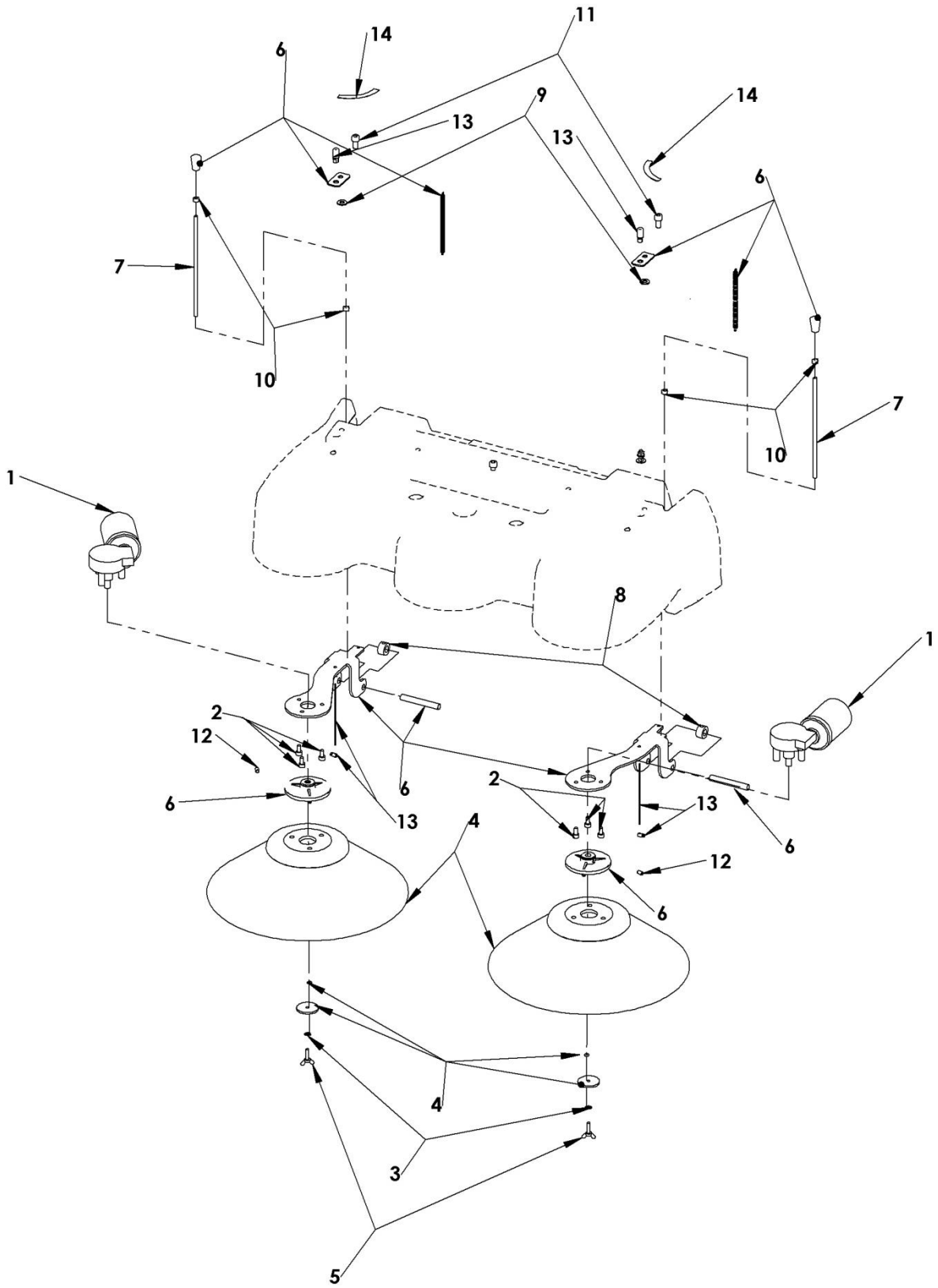

Fig. 4 – Side Brush Assy

Ref.	Part No.	Description	Qty.
▽	1	9010067 ● Motor Kit Side Brush (Includes Gear Motor Qty 1, & Mounting Hardware)	2
▲	2	N/A Screw, Soc, M6x1x12	6
▲	3	N/A Washer, Lock, M4	2
▽	4	9010040 ● Side Brush Kit (Includes Side Brush Qty1 & Mounting Hardware)	2
▲	5	N/A Wing Screw, M5x0.8x20	2
▽	6	9010169 Bracket Kit, Side Brush (Includes Side Brush Bracket lh Qty1, Side Brush Bracket rh Qty1, Side Brush Flange Qty2, Cable Bracket Qty2, Spring Qty2, Knob Qty2 & Mounting Hardware)	1
▲	7	N/A Screw, Stud, M8x1.25x200	2
▲	8	N/A Adjusting Ring D=12	2
▲	9	N/A Washer, Flat, M6	2
▲	10	N/A Nut, Hex, Std, M6	4
▲	11	N/A Screw, Soc, M8x1.25x16	2
▲	12	N/A Screw, Headless, M6x1x10	2
	13	9010053 ● Side Brush Lift Cable Kit (Includes Side Brush Cables Qty2 & Cable Fitting Qty2)	1
	14	9010103 ● Label Kit (Includes Tennant Logo Qty1, Label S9 Qty2, Label Warning NA Qty1, Label Warning EU Qty1, Label Side Brush Qty1, Label Main Brush Qty1, Label Shaker Qty1)	1

▽ ASSEMBLY

▲ INCLUDED IN ASSEMBLY

● RECOMMENDED STOCK ITEM

N/A Not Available Separately. Local Purchase.

Fig. 5 – Filter and Shaker Assy

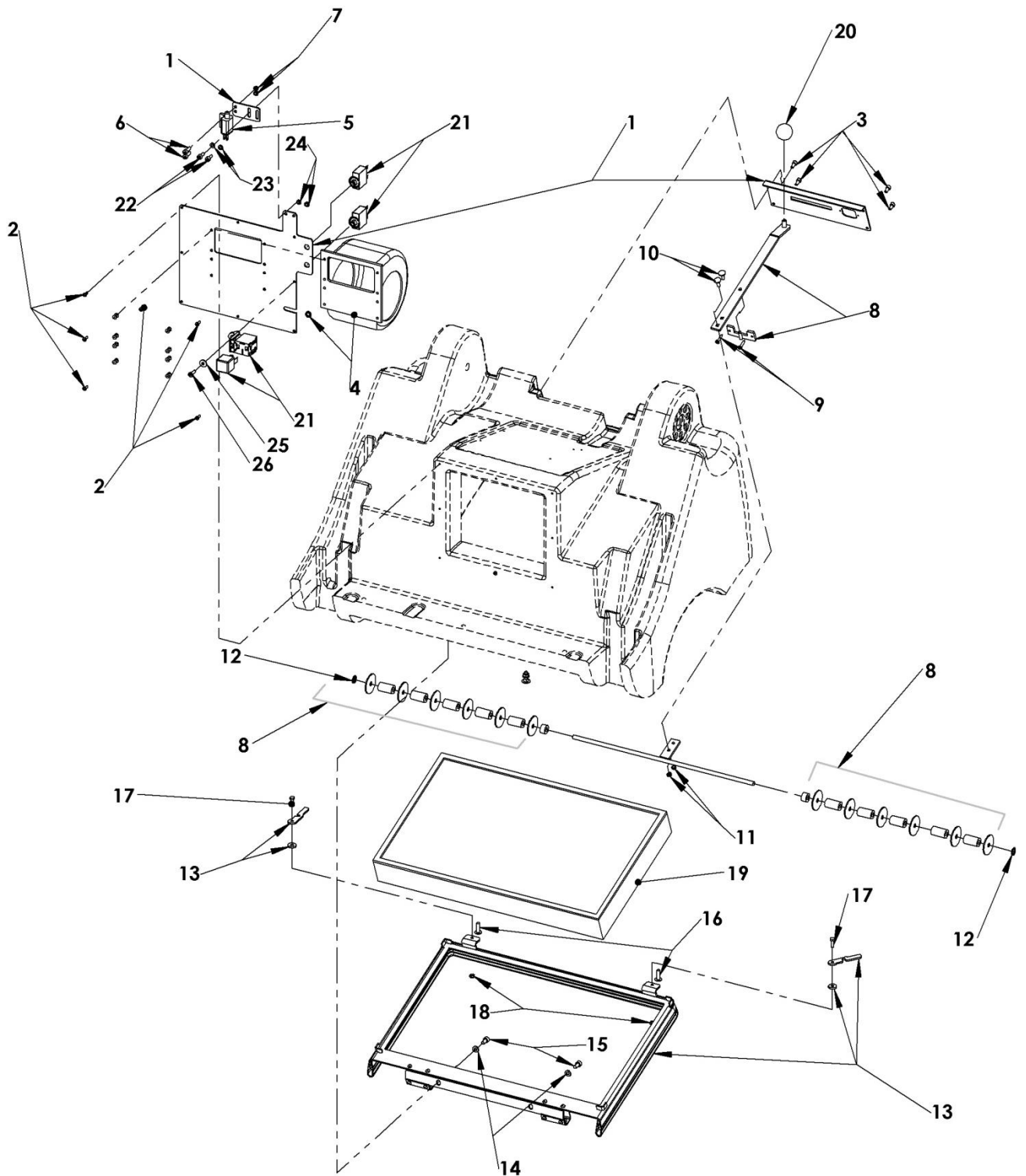

Fig. 5 – Filter and Shaker Assy

Ref.	Part No.	Description	Qty.	
▽	1	9010168	Bracket Kit, Fan, Batt (Includes Fan Bracket Qty1, Shaker Bracket Qty1, Switch Holder Qty1, & Mounting Hardware)	1
▲	2	N/A	Screw, Pan, 3.5x16 TCUT	7
▲	3	N/A	Screw, Soc, M5x0,8x10	4
	4	9010065 ●	Fan Blower Kit (Includes Fan Qty1 & Mounting Hardware)	1
▽	5	9010046 ●	Switch Kit (Includes Switch & Mounting Hardware)	1
▲	6	N/A	Screw, Soc, M5x0.8x16	2
▲	7	N/A	Nut, Hex, Lock, M5	2
▽	8	9010062	Shaker Kit (Includes Bracket Qty1, Lever Qty1, Axle Qty1, Bushing Qt2, Bushing Qty10, Rubber Disc Qty12 & Mounting Hardware)	1
▲	9	N/A	Screw, Pan, 4x20 TCUT	2
▲	10	N/A	Bolt Carriage, M5x0.8x16	2
▲	11	N/A	Nut, Hex, Lock, M5	2
▲	12	N/A	Retainment Ring D=8	2
▽	13	9010193	Filter Holder Kit (Includes Filter Bracket Qty1, Hinge Bracket Qty1, Hinge Bracket Qty2, Hinge Qty4, Sealing Qty1, Locking Handle Qty2 & Mounting Hardware)	1
▲	14	N/A	Washer, Flat M6	2
▲	15	N/A	Screw, Soc, M6x1x12	2
▲	16	N/A	Screw, Rnd M6x1x20	2
▲	17	N/A	Screw, Hex, M5x0,8x16	2
▲	18	N/A	Nut, Hex, Lock, M5	2
	19	9010042 ●	Filter Kit (Includes FilterQty1)	1
	20	9010011 ●	Knob Kit (Includes Black Balls M8 Qty 2, Yellow Balls M8 Qty 1, Knurled Knob M10 Qty 2, Knurled Knob M6 Qty 1 & Mounting Hardware)	1
▽	21	9010418 ●	Circuit Breaker and Relay Kit (Includes Circuit Breaker 20A Qty1, Circuit Breaker 25A Qty1, Relay Holder Qty1, Relay Qty1 & Mounting Hardware)	1
▲	22	N/A	Screw, Hex, M5x0,8x12	2
▲	23	N/A	Washer, Flat M5	2
▲	24	N/A	Nut, Hex, Lock, M5	2
▲	25	N/A	Washer, flat M5 D=15	1
▲	26	N/A	Screw, Pan, 4.8x16 TCUT	1

▽ ASSEMBLY

▲ INCLUDED IN ASSEMBLY

● RECOMMENDED STOCK ITEM

N/A Not Available Separately. Local Purchase.

Fig. 6 – Cover and Electrical Assy

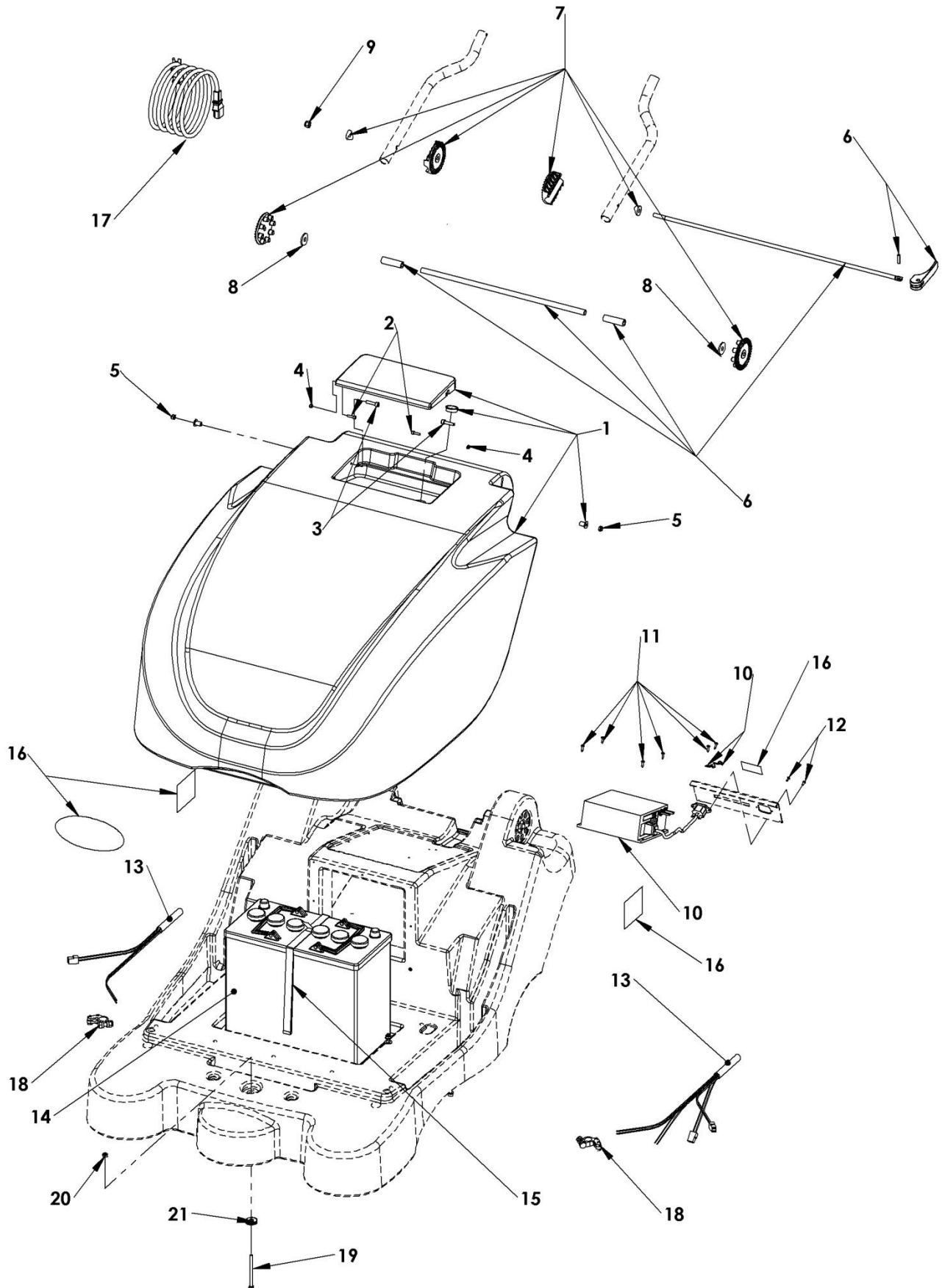

Fig. 6 – Cover and Electrical Assy

Ref.	Part No.	Description	Qty.	
▽	1	9010137	Front Cover Kit (Includes Frontcover Qty1, Flap Qty1, Plug Qty 1, Sleeve Qty 2, Knurled Knob Qty 1 & Mounting Hardware)	1
▲	2	N/A	Screw, Soc, M4x0.7x16	2
▲	3	N/A	Screw, Soc, M6x0.8x25	2
▲	4	N/A	Nut, Hex, Lock, M4	2
▲	5	N/A	Nut, Hex, Lock, M6	2
	6	9010180	Handle Rod & Lever Kit (Includes Lever Qty1, Pipe Long Qty1, Pipe Short Qty2, Rod Qty1 & Spring 6x22)	1
▽	7	9010034 ●	Handle Pivot Disc Kit (Includes Hinge Outside Qty2, Hinge Inside Qty2, Plastic Disc Qty2, & Mounting Hardware)	1
▲	8	N/A	Washer, Flat, M8x28	2
▲	9	N/A	Nut, Hex, Lock, M8	1
▽	10	9010048 ●	Charger Kit (Includes Charger Qty1, Clamp Qty2 & Mounting Hardware)	
▲	11	N/A	Screw, Pan, 3.5x13 TCUT	6
▲	12	N/A	Screw, Hex, M3x0.5x8	2
	13	9010052	Wire Harness Kit	1
	14	1071125 ●	Battery NA	1
	14	994201 ●	Battery EU	1
	15	9010168	Bracket Kit Battery and Fan (Includes Strap Qty1)	1
	16	9010103 ●	Label Kit (Includes Tennant Logo Qty1, Label S9 Qty2, Label Warning NA Qty1, Label Warning EU Qty1, Label Side Brush Qty1, Label Main Brush Qty1, Label Shaker Qty1)	1
	17	1044067 ●	Cord, Power, 16/3 BLK [2,5meter, US/JP]	1
		1044069 ●	Cord, Power, BLK [2,5meter, BRZL/UK]	
		1044068 ●	Cord, Power, BLK [2,5meter, KOR/CE]	
		1026325 ●	Cord, Power, 1.0mm ² /3 BLK [2,5meter, AUS]	
		1026330 ●	Cord, Power, 1,000mm ² BLK [2,5meter, CHINA]	
	18	9010474 ●	Terminal Clamp Kit, Battery (Includes "+" Terminal Qty1, "-" Terminal Qty1)	1
	19	N/A	Screw, Hex, M6x1x90 (Included with item 1)	1
	20	N/A	Nut, Hex, Lock, M6 (Included with item 1)	1
	21	N/A	Knob, Knurled, M6 (Included with Item 1)	1

Note: Knob also included with Knob Kit 9010011

▽ ASSEMBLY

▲ INCLUDED IN ASSEMBLY

● RECOMMENDED STOCK ITEM

N/A Not Available Separately. Local Purchase.

Fig. 7 – Handle Assy

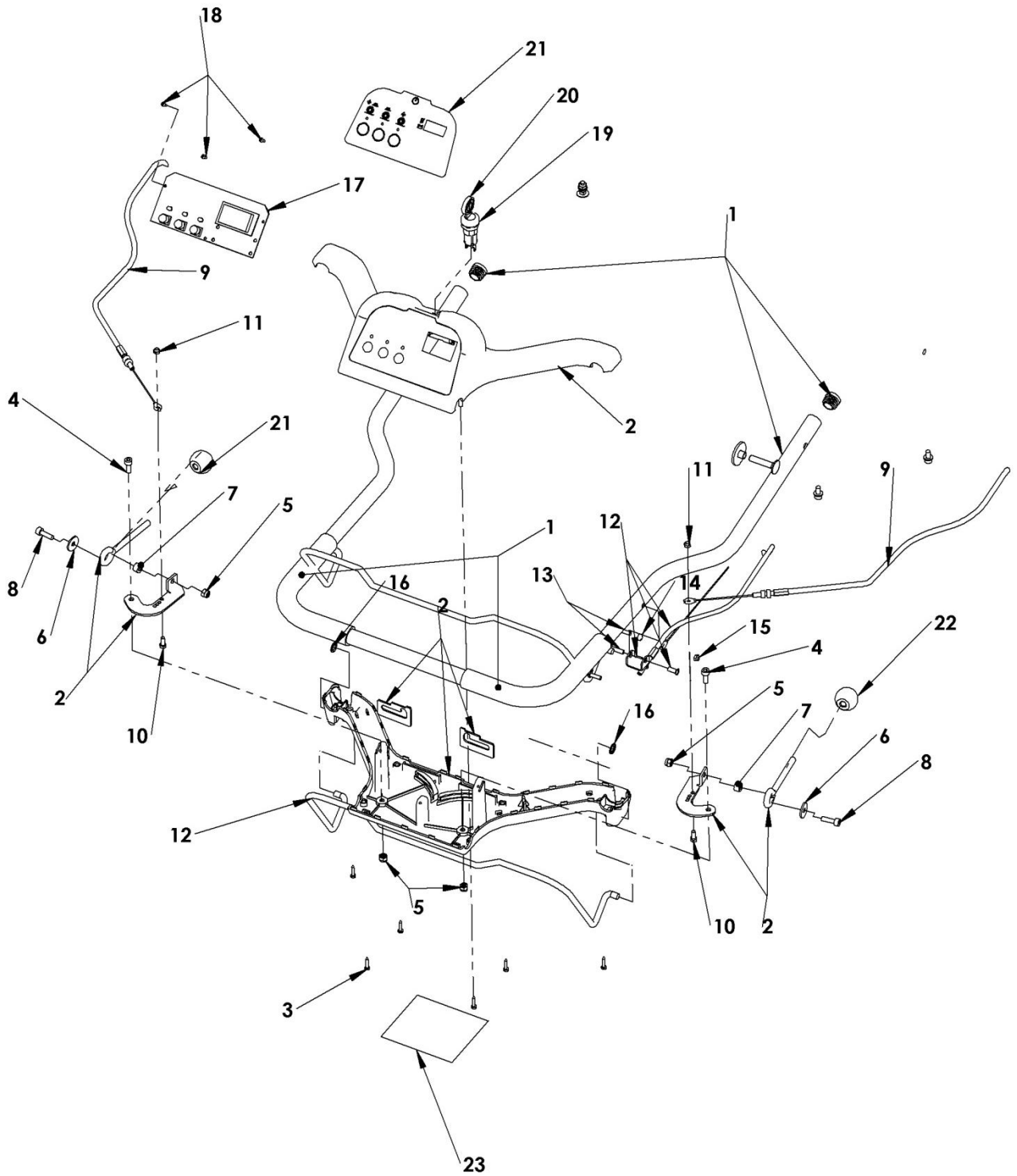

Fig. 7 – Handle Assy

Ref.	Part No.	Description	Qty.	
	1	9010033	Handle Kit (Includes Handle Qty 1, Softgripp Qty2, Plugs Qty2)	1
▽	2	9010044	Inst Panel Kit (Includes Panel Top Qty1, Panel Bottom Qty1, Slotted Bracket Qty2, Adjuster Bracket lh Qty1, Adjuster Bracket rh Qty1, Eye Bolt Qty2 & Mounting Hardware)	1
▲	3	N/A	Screw, Pan 3.5x20 TCUT	6
▲	4	N/A	Screw, Soc M6x1x12	2
▲	5	N/A	Nut, Hex, Lock, M6	4
▲	6	N/A	Washer, Flat M6x22	2
▲	7	N/A	Sleeve M6	2
▲	8	N/A	Screw, Soc M6x1x20	2
▽	9	9010053 ●	Side Brush Lift Cable Kit (Includes Side Cables Qty2, Side Cable Qty1 & Mounting Hardware)	1
▲	10	N/A	Screw, Hex M5x0.8x20	2
▲	11	N/A	Nut, Hex, Lock, M5	2
▽	12	9010175 ●	Bail and Cable Kit Propel (Includes Bail Qty1, Clutch Cable Qty1, Bracket Qty1, Sleeve Nut Qty1 & Mounting Hardware)	1
▲	13	N/A	Screw, Soc M5x0.8x20	2
▲	14	N/A	Nut, Hex, Std, M5	1
▲	15	N/A	Nut, Hex, Lock, M5	1
▲	16	N/A	Retainment Ring 8	2
▽	17	9010050 ●	Controller Kit (Includes Controller Qty1 & Mounting Hardware)	1
▲	18	N/A	Screw, Pan 2.9x13 TCUT	3
▽	19	9010045 ●	Key Switch	1
▲	20	1017696 ●	Key, Replacement	1
	21	1071274 ●	Inst Panel Label	1
	22	9010011 ●	Knob Kit (Includes Black Balls M8 Qty 2, Yellow Balls M8 Qty 1, Knurled Knob M10 Qty 2, Knurled Knob M6 Qty 1 & Mounting Material)	1
	23	9010103 ●	Label Kit (Includes Tennant Logo Qty1, Label S9 Qty2, Label Warning NA Qty1, Label Warning EU Qty1, Label Main Brush Qty1, Label Shaker Qty1)	1

▽ ASSEMBLY

▲ INCLUDED IN ASSEMBLY

● RECOMMENDED STOCK ITEM

