



E86014-00



FOREMAN™ AS20B

20" Automatic Scrubber



Operator's Manual Parts Schematic

GRUPPO BASAMENTO SPAZZOLA 450B-BT / 500B-BT
 BRUSH BASE ASSEMBLY 450B-BT / 500B-BT
 GROUPE EMBASE DE BROUSSE 450B-BT / 500B-BT
 GRUPPE BÜRSTENGESTELL 450B-BT / 500B-BT
 GRUPO BANCADA CEPILLO 450B-BT / 500B-BT

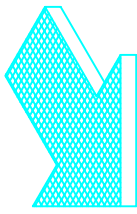
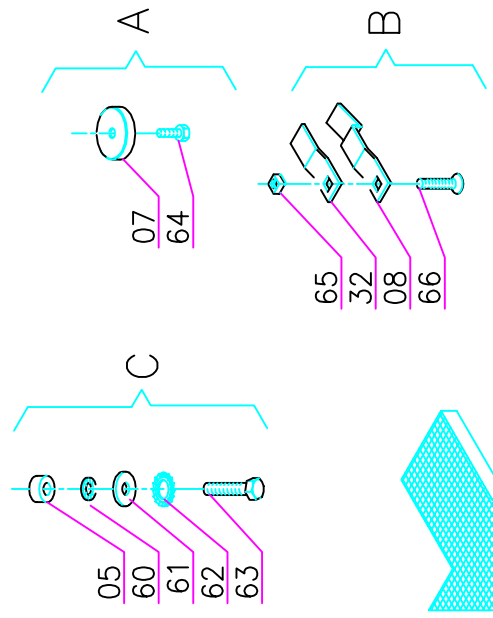
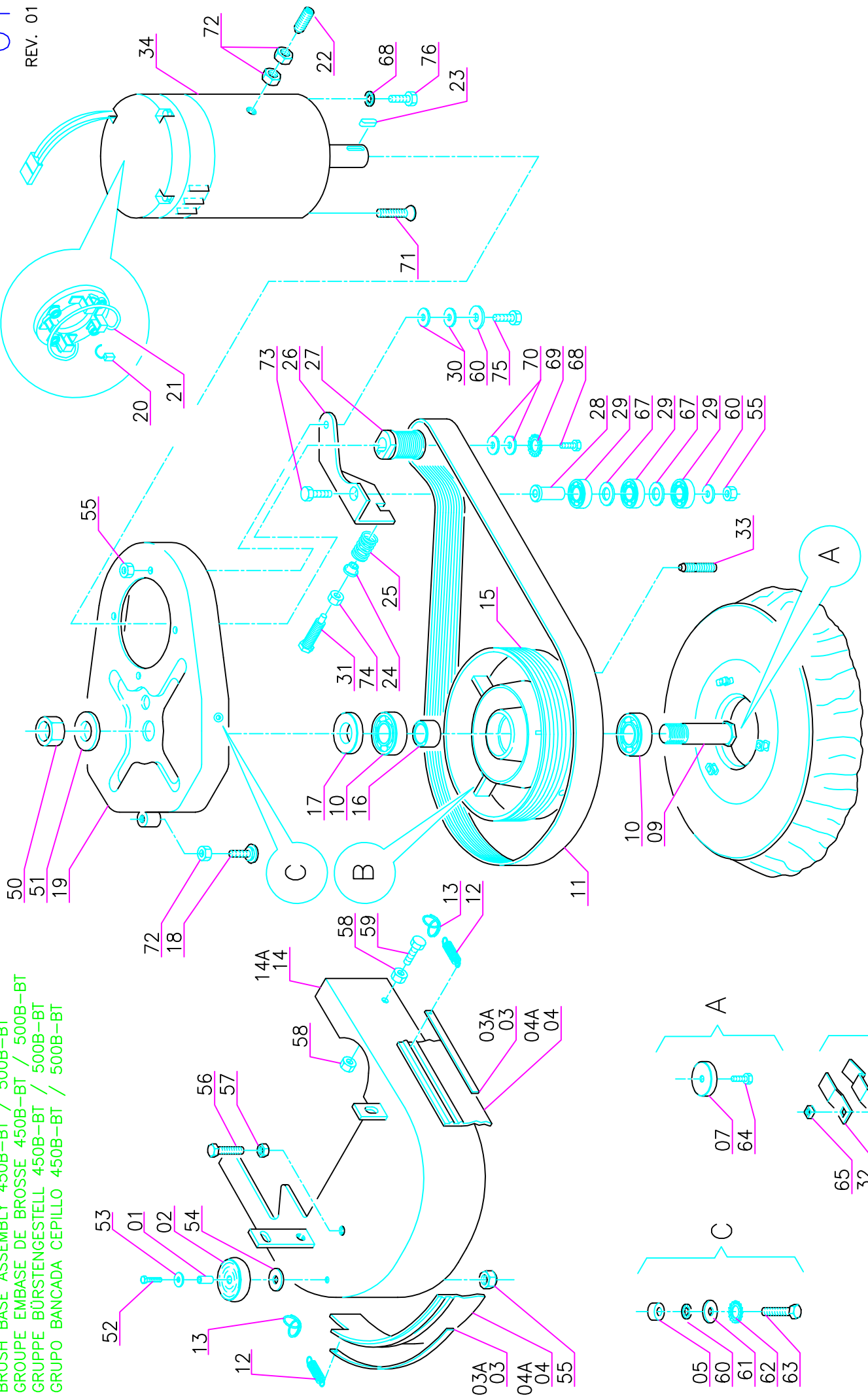

TAV.01

rev.01

GRUPPO BASAMENTO SPAZZOLA 450 B-BT / 500 B-BT

Pos.	Mod.	Codice	Q.tà	Denominazione	Denomination	Description	Benennung	Description
1		408021	1	BOCCOLA	BUSHING	BAGUE	BUCHSE	CASQUILLO
2		405708	1	RUOTA PARACOLPI	WHEEL	ROUE	RAD	RUEDA
3	450 B-BT	415131	1	LISTELLO PARASPRUZZI	BLADE	LAME	LEISTE	LISTON
3A	500 B-BT	415132	1	LISTELLO PARASPRUZZI	BLADE	LAME	LEISTE	LISTON
4	450 B-BT	202266	1	PARASPRUZ. MAXIMA 502B/450B-BT	SPLASH GUARD	BAVETTE	SPRITZGUMMI	PARASALPICADURAS
4A	500 B-BT	202264	1	PARASPRUZZI MAXIMA 500 B-BT	SPLASH GUARD	BAVETTE	SPRITZGUMMI	PARASALPICADURAS
5		408073	2	BOCCOLA BASAMENTO	BUSHING	BAGUE	BUCHSE	CASQUILLO
7		400721	1	RONDELLA SPECIALE	WASHER SPRING	RONDELLE RESSORT	SCHIEBE FEDER	ARANDELA RESORTE
8		407598	1	MOLLA BLOCCAGGIO SPAZZOLA	SHAFT	ARBRE	LENKWELLE	EJE
9		203283	1	ALBERO	BEARING	ROULEMENT	LAGER	COJINETE
10		408441	2	CUSCINETTO A SFERE 6205-2RS1	BELT	COURROIE	RIEMEN	CORREA
11		408319	1	CINGHIA POLY V J14-769	SPRING	RESSORT	FEDER	RESORTE
12		408113	2	MOLLA	RING	ANNEAU	RING	ANILLO
13		400415	2	ANELLO INOX DI AGGANCIO MOLLA	SUPPORT	SUPPORT	HALTERUNG	SOPORTE
14	450 B-BT	412447	1	SUPPORTO BASAMENTO	SUPPORT	SUPPORT	HALTERUNG	SOPORTE
14A	500 B-BT	412448	2	SUPPORTO BASAMENTO	PULLEY	POULIE	RIEMENSCHIEBE	POLEA
15		210288	1	PULEGGIA TRASC.	SAPCER	ENTRETOISE	DIETANZHÜLSE	DISTANCIADOR
16		210104	1	DISTANZIALE	SAPCER	ENTRETOISE	DIETANZHÜLSE	DISTANCIADOR
17		206508	1	DISTANZIALE	SAPCER	ENTRETOISE	DIETANZHÜLSE	DISTANCIADOR
18		408624	1	VITE 8X40 UNI 5732-65	SCREW	VIS	SCHRAUBE	TORNILLO
19		202554	1	BASAMENTO MAXIMA 450	BASE	BASE	UNTERTEIL	BASE
20		409420	4	SPAZZ. MOT. 10X18X18 GM4EC01	CARBON BRUSH	CHARBON MOTEUR	KOHLEBURSTE	ESCOBILLA MOTOR
21		412435	1	SUPPORTO SPAZZOLA	CARBON BRUSH HOLDER	PORTE-CHARBON	KOHLEBURSTENHALT	PORTAESCOBILLAS
22		411962	1	GRANO M8x40 TESTA PIANA	DOWEL	VIS	MADENSCHRAUBE	TORNILLO
23		408402	1	LINGUETTA 5X5X20 UNI 6604/A	TONGUE	LANGUETTE	PASSFEDER	CLAVETA
24		210191	1	BOCCOLA BASAMENTO	BUSHING SPRING	BAGUE RESSORT	BUCHSE FEDER	CASQUILLO RESORTE
25		408091	1	MOLLA COMPR.	BRACKET	ATTAQUE	BÜGEL	SOPORTE FIJADOR
26		203490	1	STAFFA TENDICINGHIA	PULLEY	POULIE	RIEMENSCHIEBE	POLEA
27		202502	1	PULEGGIA MOTORE MAXIMA	BUSHING	BAGUE	BUCHSE	CASQUILLO
28		204365	1	BOCCOLA TENDICINGHIA	BEARING	ROULEMENT	LAGER	COJINETE
29		408427	3	CUSCINETTO A SFERE 6202-2RS1	CUPPED WASHER	RONDELLE CONCAVE	UNTERLAGSCHEIBE	ARANDELA CONCAVA
30		409186	2	MOLLA A TAZZA	REGISTER REINFORCEMENT SPRING	REGISTRE RESSORT RENFORCE	REGISTER VERSTAERKUNGSFEDER	REGISTRO REFUERZO
31		203285	1	REGISTRO	DOWEL	VIS	MADENSCHRAUBE	TORNILLO
32		407599	1	MOLLA DI RINFORZO	MOTOR	MOTEUR	MOTOR	MOTOR
33		408903	1	GRANO M6X10 UNI 5929	NUT	ECROU	MUTTER	TUERCA
34		407709	1	MOTORE MP 100S 24V 560W 1400g	WASHER	RONDELLE	SCHIEBE	ARANDELA
50		-	-	DADO M24 UNI 5588	SCREW	VIS	SCHRAUBE	TORNILLO
51		-	-	ROSETTA M24 UNI 6592	WASHER	RONDELLE	SCHIEBE	ARANDELA
52		-	-	VITE M8X40 UNI 5739	WASHER	RONDELLE	SCHIEBE	ARANDELA
53		-	-	ROSETTA M8 UNI 6592	WASHER	RONDELLE	SCHIEBE	ARANDELA
54		-	-	ROSETTA M8 D.32 UNI 6593	WASHER	RONDELLE	SCHIEBE	ARANDELA
55		-	-	DADO M8 AUTOBL. UNI 7474	LOCK NUT	ECROU AUTOBLOQUANT	STOPMUTTER	TUERCA AUTOBLOCANTE

GRUPPO BASAMENTO SPAZZOLA 450B-BT / 500B-BT
 BRUSH BASE ASSEMBLY 450B-BT / 500B-BT
 GROUPE EMBASE DE BROSSE 450B-BT / 500B-BT
 GRUPPE BÜRSTENGESTELL 450B-BT / 500B-BT
 GRUPO BANCADA CEPILLO 450B-BT / 500B-BT

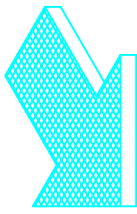
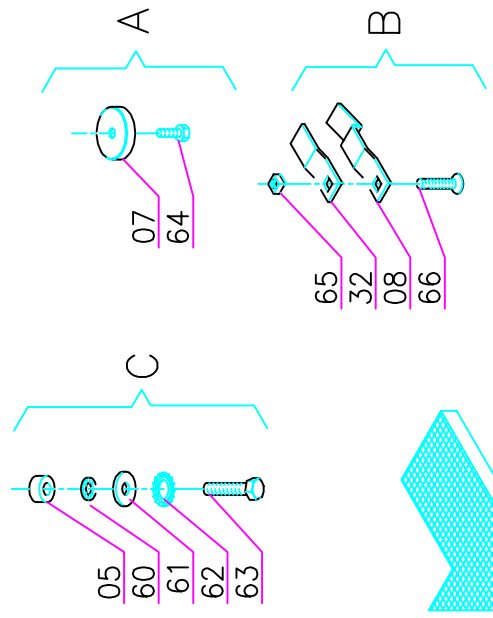
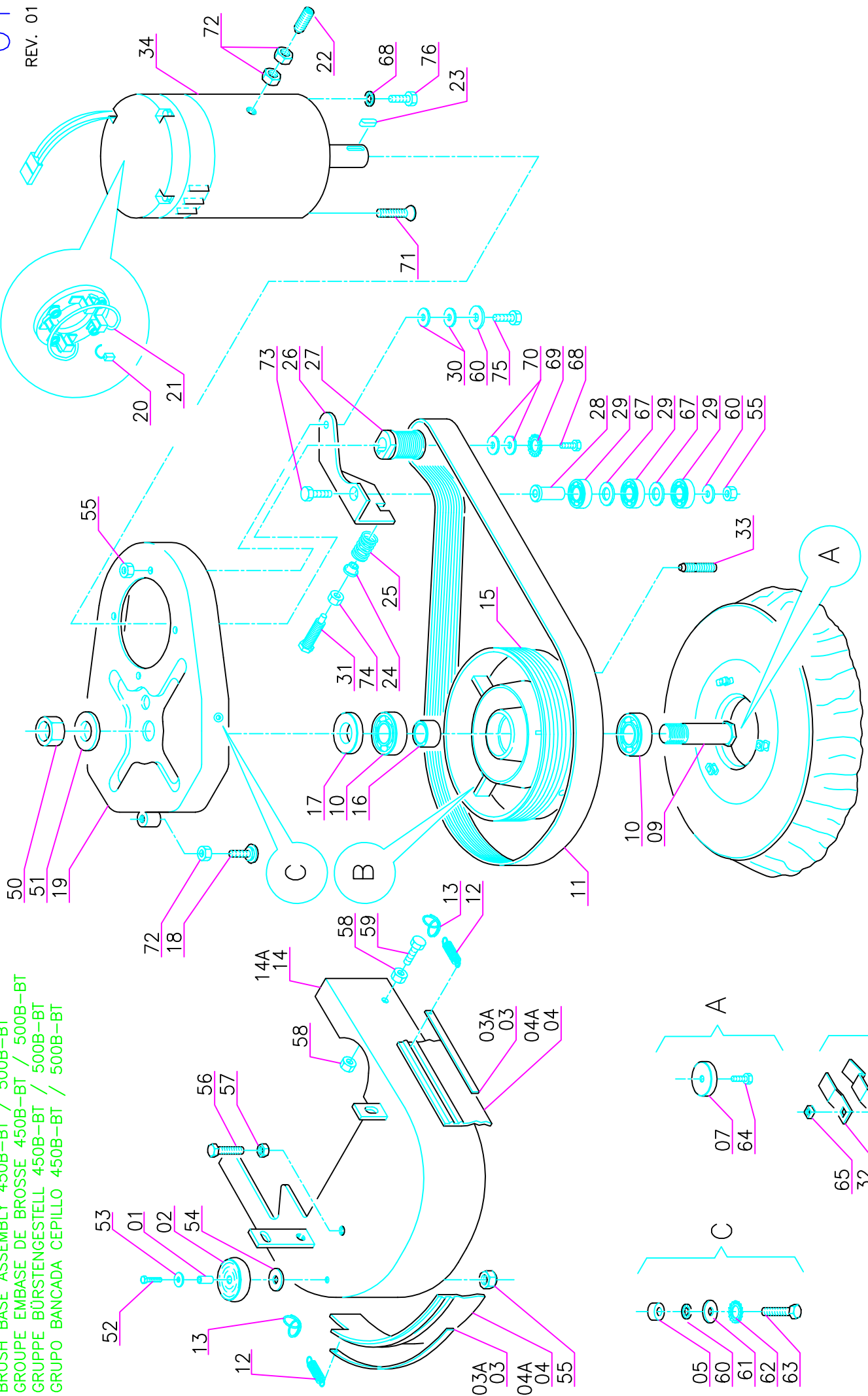

TAV.01 rev.01 GRUPPO BASAMENTO SPAZZOLA 450 B-BT / 500 B-BT

Pos.	Mod.	Codice	Q.tà	Denominazione	Denomination	Description	Benennung	Description
56	-	-	-	VITE M6X30 UNI 5739	SCREW	VIS	SCHRAUBE	TORNILLO
57	-	-	-	DADO M6 UNI 5588	NUT	ECROU	MUTTER	TUERCA
58	-	-	-	DADO M5 SERPRESS	NUT	ECROU	MUTTER	TUERCA
59	-	-	-	VITE M5X20 UNI 5739 A2	SCREW	VIS	SCHRAUBE	TORNILLO
60	-	-	-	ROSETTA M8 D.24 UNI 6593	WASHER	RONDELLE	SCHIBE	ARANDELA
61	-	-	-	ROSETTA M8 DIN 6798/A	LOCK WASHER	RONDELLE	ZAHNSCHIEBE	ARANDELA DENTADA
62	-	-	-	ROSETTA M8 SCHNORR	LOCK WASHER	RONDELLE	ZAHNSCHIEBE	ARANDELA DENTADA
63	-	-	-	VITE M8X20 UNI 5739	SCREW	VIS	SCHRAUBE	TORNILLO
64	-	-	-	VITE M6X35 UNI 5739	SCREW	VIS	SCHRAUBE	TORNILLO
65	-	-	-	DADO M6 A GABBIA	NUT	ECROU	MUTTER	TUERCA
66	-	-	-	VITE M6X20 UNI 5933 A2	SCREW	VIS	SCHRAUBE	TORNILLO
67	-	-	-	ROSETTA M14 UNI 6592 OTTONE	WASHER	RONDELLE	SCHIBE	ARANDELA
68	-	-	-	VITE M6X18 UNI 5739	SCREW	VIS	SCHRAUBE	TORNILLO
69	-	-	-	ROSETTA M6 DIN 6798/A	LOCK WASHER	RONDELLE	ZAHNSCHIEBE	ARANDELA DENTADA
70	-	-	-	ROSETTA M6 D.18 UNI 6593	WASHER	RONDELLE	SCHIBE	ARANDELA
71	-	-	-	VITE M6X16 UNI 5933	SCREW	VIS	SCHRAUBE	TORNILLO
72	-	-	-	DADO M8 UNI 5588	NUT	ECROU	MUTTER	TUERCA
73	-	-	-	VITE M8X55 UNI 5933	SCREW	VIS	SCHRAUBE	TORNILLO
74	-	-	-	DADO M12X1.25 UNI 5588	NUT	ECROU	MUTTER	TUERCA
75	-	-	-	VITE M8X25 UNI 5739	SCREW	VIS	SCHRAUBE	TORNILLO
76	-	-	-	VITE M6X18 UNI 5739	SCREW	VIS	SCHRAUBE	TORNILLO

GRUPPO BASAMENTO SPAZZOLE 452 B-BT / 502 B-BT
 BRUSHES BASE ASSEMBLY 452 B-BT / 502 B-BT
 GROUPE PLATEAU DES BROSSES 452 B-BT / 502 B-BT
 GRUPPE BÜRSTENGESTELL 452 B-BT / 502 B-BT
 GRUPO BANCADA CEPILLOS 452 B-BT / 502 B-BT

01A
 REV. 0'

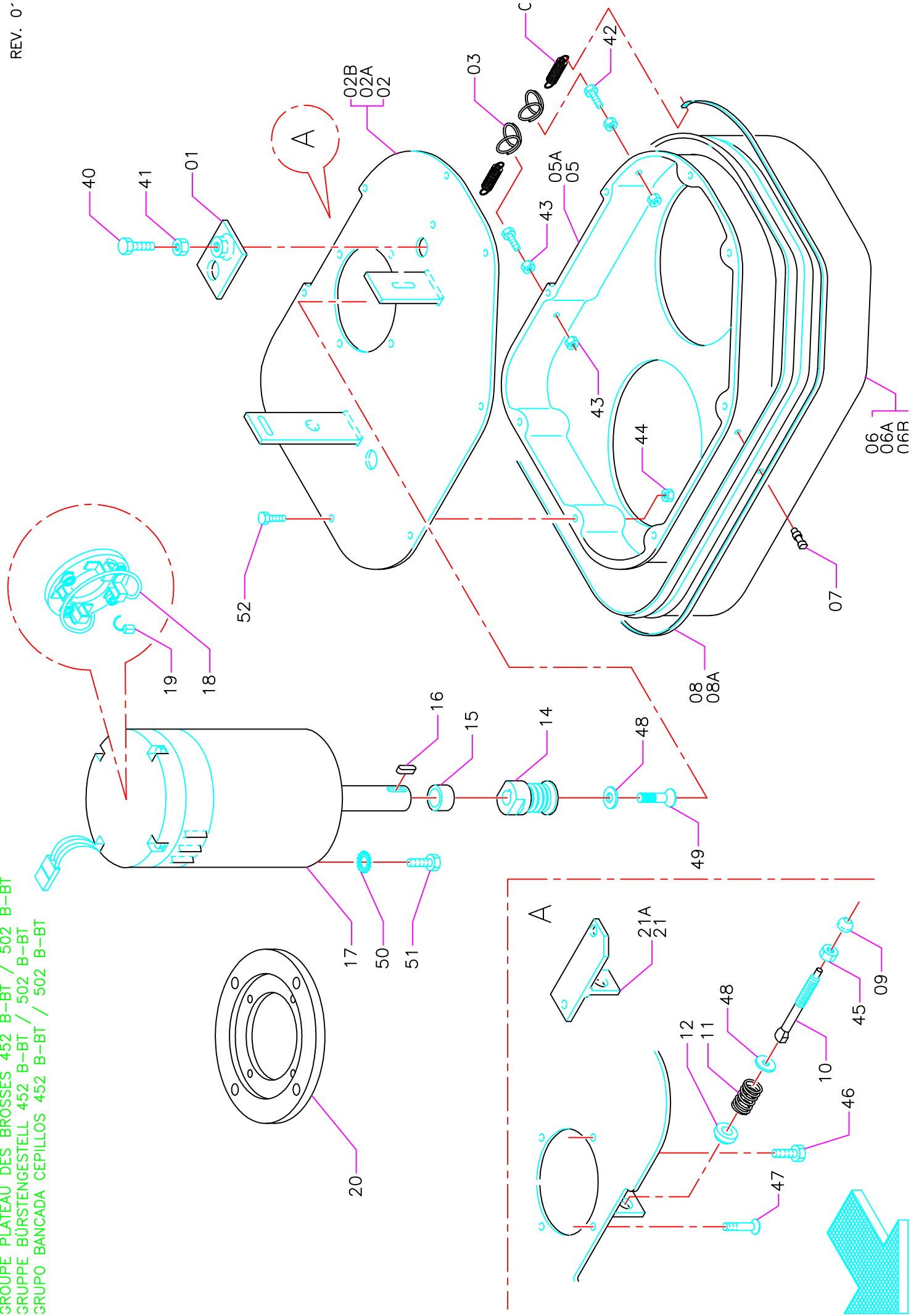

TAV.01A

rev.01

GRUPPO BASAMENTO SPAZZOLE 452 B-BT / 502 B-BT

Po	Mod.	Codice	Q.tà	Denominazione	Denomination	Description	Benennung	Description
1	452-502B	204370	1	PIASTRINA DI REGOLAZIONE	SUPPORT PLATE	PLAQUETTE	STÜTZPLATTE	OREJA DE APOYO
2	452 B-BT	202559	1	BASAMENTO MAXIMA	BASE	BASE	UNTERTEIL	BASE
2A	502 B-BT	E9825020	1	BASAMENTO MAXIMA	BASE	BASE	UNTERTEIL	BASE
2B	*	202560	1	BASAMENTO	BASE	BASE	UNTERTEIL	BASE
3		400415	2	ANELLO INOX DI AGGANCIAMENTO MOLLA	RING	BAGUE	RING	ANILLO
4		408113	2	MOLLA	SPRING	RESSORT	FEDER	RESORTE
5	452 B-BT	202555	1	CARTER BASAMENTO	BASE COVER	PROTECTION	ABDECKUNG	PROTECCION BANCADA
5A	502 B-BT	202556	1	CARTER BASAMENTO	BASE COVER	PROTECTION	ABDECKUNG	PROTECCION BANCADA
6	452 B	202265	1	PARASPRUZZI	SPLASH GUARD	BAVETTE	SPRITZGUMMI	PARASALPICADURAS
6A	452 BT	202267	1	PARASPRUZZI	SPLASH GUARD	BAVETTE	SPRITZGUMMI	PARASALPICADURAS
6B	502 B	202266	1	PARASPRUZZI	SPLASH GUARD	BAVETTE	SPRITZGUMMI	PARASALPICADURAS
6C	502 BT	202268	1	PARASPRUZZI	SPLASH GUARD	BAVETTE	SPRITZGUMMI	PARASALPICADURAS
7		206170	1	ATTACCO LISTELLO PARASPRUZZI	JOINT	EMBRAYAGE	KUPPLUNG	JUNTURA
8	452 B-BT	400666	2	LISTELLO PARASPRUZZI SX	LEFT BLADE	PLAQUETTE GAUCHE	LEISTE LNIKS	LISTON IZQUIERDO
8A	502 B-BT	400636	2	LISTELLO PARASPRUZZI SX	LEFT BLADE	PLAQUETTE GAUCHE	LEISTE LNIKS	LISTON IZQUIERDO
9		204364	1	BOCCOLA SFERICA	BUSHING	BAGUE	BUCHSE	CASQUILLO
10		204368	1	REGISTRO TENDICINGHIA	REGISTER	REGISTRE	REGISTER	REGISTRO
11		408091	1	MOLLA	SPRING	RESSORT	FEDER	RESORTE
12		408032	1	BOCCOLA	BUSHING	BAGUE	BUCHSE	CASQUILLO
14		202511	1	PULEGGIA MOTORE	MOTOR PULLEY	POULIE DE MOTEUR	RIEMENSCHLEIBE MOTOR	POLEA DE MOTOR
15		210117	1	DISTANZIALE	SPACER	ENTRETOISE	DISTANZHÜLSE	DISTANCIADOR
16		408402	1	LINGUETTA	TONGUE	LANGUETTE	PASSFEDER	CLAVETA
17		411738	1	MOTORE MP80S/2 24V 600W 3500G	MOTOR	MOTEUR	MOTOR	MOTOR
18		409722	1	SUPPORTO SPAZZOLA GM4EC01 RAME	CARBON BRUSH HOLDER	PORTE-CHARBON	KOHLEBURSTENHALTERUNG	PORTAESCOBILLAS
19		409412	4	SPAZZ. MOT. 7X14X19 GM4EC01	CARBON BRUSH MOTOR	CHARBON MOTEUR	KOHLEBURSTE	ESCOBILLA MOTOR
20		415470	1	FLANGIA DI ADATTAMENTO MOTORE	FLANGE	FLASQUE	FLANSCH	BRIDA
21		400319	1	SUPPORTO TENDICINGHIA	SUPPORT	SUPPORT	HALTERUNG	SOPORTE
21A	452-502B	202556	1	SUPPORTO TENDICINGHIA	SUPPORT	SUPPORT	HALTERUNG	SOPORTE
40	452-502B	-	-	VITE M10X30 UNI 5739	SCREW	VIS	SCHRAUBE	TORNILLO
41	452-502B	-	-	DADO M10 UNI 5589	NUT	ECROU	MUTTER	TUERCA
42		-	-	VITE M5X20 UNI 5739 A2	SCREW	VIS	SCHRAUBE	TORNILLO
43		-	-	DADO M5 SERPRESS	NUT	ECROU	MUTTER	TUERCA
44		-	-	DADO M5 AUTOBL. UNI 7474	LOCK NUT	ECROU AUTOBLOQUANT	STOPMUTTER	TUERCA AUTOBLOCANTE
45		-	-	DADO M10 AUTOBL. UNI 7474	LOCK NUT	ECROU AUTOBLOQUANT	STOPMUTTER	TUERCA AUTOBLOCANTE
46		-	-	VITE M8X30 UNI 5739	SCREW	VIS	SCHRAUBE	TORNILLO
47		-	-	VITE M8X30 UNI 5933	SCREW	VIS	SCHRAUBE	TORNILLO
48		-	-	ROSETTA M10 UNI 6593	WASHER	RONDELLE	SCHEIBE	ARANDELA
49		-	-	VITE M6X20 UNI 5739	SCREW	VIS	SCHRAUBE	TORNILLO
50		-	-	ROSETTA M6 DIN 6798/A	LOCK WASHER	RONDELLE	ZAHNSCHLEIBE	ARANDELA DENTADA
51		-	-	VITE M6X18 UNI 5739	SCREW	VIS	SCHRAUBE	TORNILLO
52		-	-	VITE M5X12 UNI 5739	SCREW	VIS	SCHRAUBE	TORNILLO

* = 502B KLINIK LINE

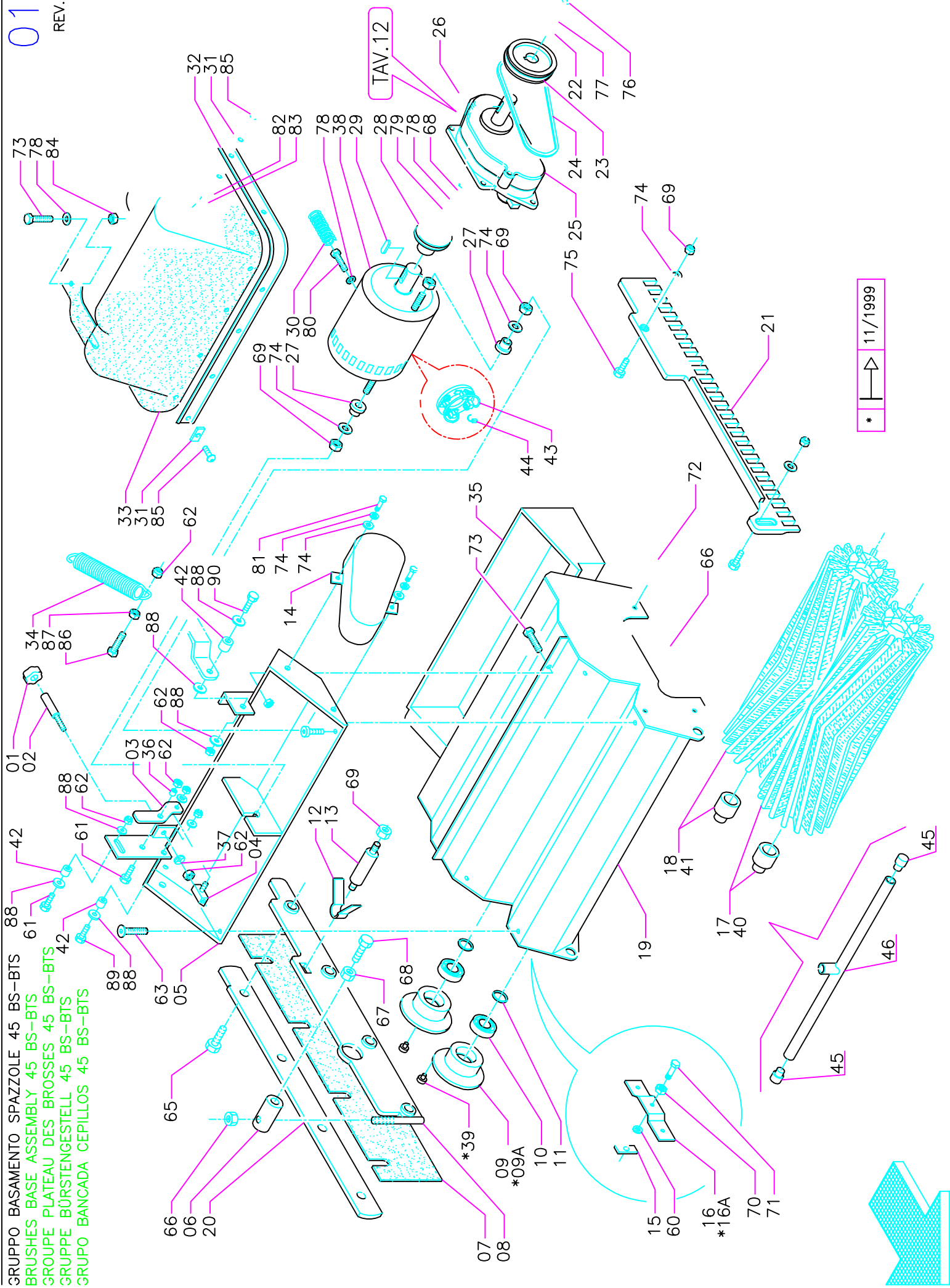

GRUPPO BASAMENTO SPAZZOLE 45 BS-BTS
 BRUSHES BASE ASSEMBLY 45 BS-BTS
 GROUPE PLATEAU DES BROSSES 45 BS-BTS
 GRUPPE BÜRSTENGESTELL 45 BS-BTS
 GRUPO BANCADA CEPILLOS 45 BS-BTS

* | —> 11/1999

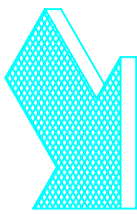

TAV.01B rev.01 GRUPPO BASAMENTO SPAZZOLE 45 BS-BTS

Pos.	Mod.	Codice	Q.tà	Denominazione	Denomination	Description	Benennung	Description
1	45BS	416158	1	POMELLO D.45 M8 FEMMINA	KNOB	POMMEAU	KUGELGRIFF	POMO
2	45BS	203528	1	TIRANTE REGISTRO	TIE ROD	TIRANT	SPANNSTANGE	TIRANTE
3	45BS	203527	1	LEVA REGISTRO TRAZIONE	LEVER	LEVIER	HABEL	PALANCA
4	45BS	203529	1	REGISTRO TRAZIONE	ADJUSTER	REGLAGE	VERSTELLSCHRAUBE	REGULADOR
5		203530	1	PIASTRA SUPPORTO MOTORE	PLAQUE	PLAQUETTE	BEFESTIGUNGSAUFLAGE	PLAQUETA
6		203438	1	ATTACCO BARRA LATERALE DX	COUPLING	ATTAQUE	KUPPLUNG	SOPORTE
7		406016	1	GOMMA LATERALE DX	RUBBER	CAUTCHOUC	GUMMI	GOMA
8		203434	1	BARRA LATERALE DX	RIGHT SIDE BAR	BARRE LATERALE DROITE	SEITENSTANGE RECHTS	BARRA LATERAL DERECHA
9		R1903010	2	SUPPORTO DX SPAZZOLA OTTONE	RIGHT SUPPORT	SUPPORT DROITE	HALTERUNG RECHTS	SOPORTE DERECHO
9A		400547	2	SUPPORTO DX SPAZZOLA OTTONE	RIGHT SUPPORT	SUPPORT DROITE	HALTERUNG RECHTS	SOPORTE DERECHO
10		408420	2	CUSCINETTO A SFERE 6001-2RS1	BEARING	ROULEMENT	LAGER	COJINETE
11		407610	2	PARAOILIO 20x28x4	OIL SEAL	JOINT PAULSTRA	SIMMERING	ARO RASCADOR DE ACEITE
12		410324	1	AGGANCIO RAPIDO C4434-7	RAPID COUPLER	ETRIER	SCHNELLVERSCHLUSS	ENCHUFE RAPIDO
13		206526	1	TESTINA AGGANCIO RAPIDO M5	HOOK HEAD	TETE DE CROCHET	VERSCHLUSS	CABEZA
14		400752	1	PROTEZIONE CINGHIA	PROTECTION	PROTECTION	ABDECKUNG	PROTECCION
15		206519	1	GALLETTO M8	WING NUT	PAPILLON	FLÜGELSCHRAUBE	POMO
16		R1903060	1	TRAVERSO FISSAGGIO	CROSS BEAM	TRAVERSE	QUERSHWELLE	TRAVERSANO
16A		400732	1	TRAVERSO FISSAGGIO	CROSS BEAM	TRAVERSE	QUERSHWELLE	TRAVERSANO
17		202865	1	SPAZZOLA COMPLETA CIL. PPL 0,5	BRUSH	BROSSE	BÜRSTE	CEPILLO
18		202866	1	SPAZZOLA COMPLETA CIL. PPL 0,3	BRUSH	BROSSE	BÜRSTE	CEPILLO
19		415155	1	TELAIO TUNNEL	FRAME	CHASSIS	RAHMEN	BASTIDOR
20		202344	1	LAMA PREMIGOMMA	BLADE	PLAQUE	PLATTE	LISTON
21		203435	1	BARRA LATERALE SX	LEFT SIDE BAR	BARRE LATERALE GAUCHE	SEITENSTANGE LINKS	BARRA LATERAL IZQUIERDA
22		206516	1	RONDELLA D.5,5x20x3	WASHER	RONDELLE	SCHEIBE	ARANDELA
23		202500	1	PULEGGIA RIDUTTORE G35	PULLEY	POULIE	RIEMENSCHIEBE	POLEA
24		408299	1	CINGHIA TRAP. LINEA-X Z16	BELT	COURROIE	RIEMEN	CORREA
25		203049	1	RIDUTTORE COMPLETO G35	REDUCTION GEAR ASSEMBLY	REDUCTEUR COMPLET	GETRIEBE KOMPLETT	GRUPO REDUCTOR
26		408401	1	LINGUETTA 5X5X12 UNI 6604/A	TONGUE	LANGUETTE	PASSFEDER	CLAVETA
27		414721	2	BOCCOLA 5,2x10x5,5	BUSHING	BAGUE	BUCHSE	CASQUILLO
28		202503	1	PULEGGIA MOTORE 14X26	MOTOR PULLEY	POULIE DE MOTEUR	RIEMENSCHIEBE MOTOR	POLEA DE MOTOR
29		408402	1	LINGUETTA 5X5X20 UNI 6604/A	TONGUE	LANGUETTE	PASSFEDER	CLAVETA
30		209846	1	MOLLA COMPR. 17X2.2X45	SPRING	RESSORT	FEDER	RESORTE
31		400689	6	PIASTRINA SOTTOVITE x PARAURTI	SUPPORT PLATE	PLAQUETTE	STÜTZPLATTE	OREJA DE APOYO
32		203543	1	PARAURTI	BUMPER	PARE-CHOCS	STOSSDÄMPFER	PARACHOQUES
33		415153	1	CARTER BASAMENTO MAXIMA 45	BASE COVER	PROTECTION	ABDECKUNG	PROTECCION BANCADA
34		202482	1	MOLLA TRAZ. 30X4X142 24SPIRE	SPRING	RESSORT	FEDER	RESORTE
35		415156	1	CASSETTO	DRAWER	TIROIR	SCHUBLADE	CAJON
36	45BS	200325	1	BOCCOLA 8,5X13X6	BUSHING	BAGUE	BUCHSE	CASQUILLO
37	45BS	409178	1	MOLLA A TAZZA 8X18X1	CUPPED WASHER	RONDELLE CONCAVE	UNTERLAGSCHEIBE	ARANDELA CONCAVA
38		407712	1	MOTORE MP80M 24V 1400g 20A	MOTOR	MOTEUR	MOTOR	MOTOR
39		409836	2	TAPPO SALVAFILETTO	CAP	CAPUCHON	KAPPE	TAPON
40	*	202867	1	SPAZZOLA COMPLETA ANT.	BRUSH	BROSSE	BÜRSTE	CEPILLO
41	*	202868	1	SPAZZOLA COMPLETA POST.	BRUSH	BROSSE	BÜRSTE	CEPILLO

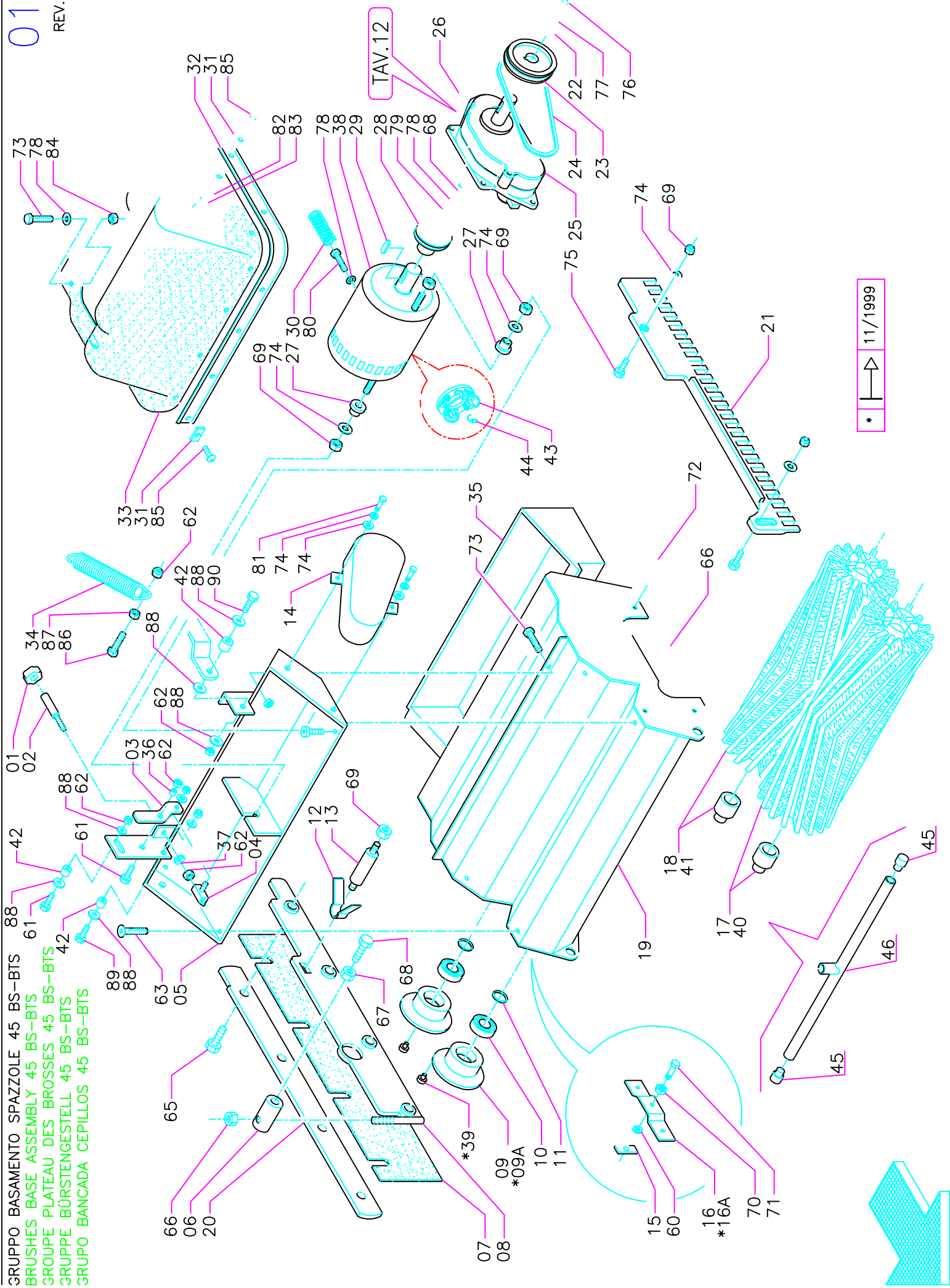

GRUPPO BASAMENTO SPAZZOLE 45 BS-BTS
BRUSHES BASE ASSEMBLY 45 BS-BTS
GROUPE PLATEAU DES BROSSES 45 BS-BTS
GRUPPE BÜRSTENGESTELL 45 BS-BTS
GRUPO BANCADA CEPILLOS 45 BS-BTS

* | —> 11/1999

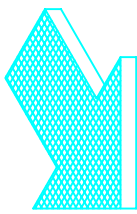

TAV.01B rev.01 GRUPPO BASAMENTO SPAZZOLE 45 BS-BTS

Pos.	Mod.	Codice	Q.tà	Denominazione	Denomination	Description	Benennung	Description
42		408018	3	BOCOLA	BUSHING	BAGUE	BUCHSE	CASQUILLO
43		409722	1	ANELLO D.95 +4CASS.7X14	CARBON BRUSH HOLDER	PORTE-CHARBON	KOHLEBURSTENHALTERUN	PORTAESCOBILLAS
44		409412	4	SPAZZOLA 7X14X19	CARBON BRUSH MOTOR	CHARBON MOTEUR	KOHLEBURSTE	ESCOBILLA MOTOR
45		409832	2	CAPPUCCIO COPRIDADO	PROTECTION CAP	CALOTTE DE PROTECTION	SICHERHEITSKAPPE	CAPUCHO
46		415157	1	TUBO DISTRIBUTORE	TUBE	TUYAU	ROHR	TUBO
60		-	-	ROSETTA M8 UNI 6592	WASHER	RONDELLE	SCHEIBE	ARANDELA
61	45BS	-	-	VITE M8X25 UNI 5739	SCREW	VIS	SCHRAUBE	TORNILLO
62		-	-	DADO M8 AUTOBL. UNI 7474	LOCK NUT	ECROU AUTOBLOQUANT	STOPMUTTER	TUERCA AUTOBLOCANTE
63		-	-	VITE M6X16 UNI 5933	SCREW	VIS	SCHRAUBE	TORNILLO
64		-	-	ROSETTA M6 UNI 6592	WASHER	RONDELLE	SCHEIBE	ARANDELA
65		-	-	VITE M6X20 UNI 5739 A2	SCREW	VIS	SCHRAUBE	TORNILLO
66		-	-	DADO M6 AUTOBL. UNI 7474	LOCK NUT	ECROU AUTOBLOQUANT	STOPMUTTER	TUERCA AUTOBLOCANTE
67		-	-	DADO M6 UNI 5588	NUT	ECROU	MUTTER	TUERCA
68		-	-	VITE M6X12 UNI 5739 A2	SCREW	VIS	SCHRAUBE	TORNILLO
69		-	-	DADO M5 AUTOBL. UNI 7474	LOCK NUT	ECROU AUTOBLOQUANT	STOPMUTTER	TUERCA AUTOBLOCANTE
70		-	-	DADO M8 UNI 5588 A2	NUT	ECROU	MUTTER	TUERCA
71		-	-	VITE M8X20 UNI 5739 A2	SCREW	VIS	SCHRAUBE	TORNILLO
72		-	-	VITE M6X20 UNI 5732	SCREW	VIS	SCHRAUBE	TORNILLO
73		-	-	VITE M6X16 UNI 5739 A2	SCREW	VIS	SCHRAUBE	TORNILLO
74		-	-	ROSETTA M5 D.15 UNI 6593	WASHER	RONDELLE	SCHEIBE	ARANDELA
75		-	-	VITE M5X16 UNI 7688 A2	SCREW	VIS	SCHRAUBE	TORNILLO
76		-	-	VITE M5X25 UNI 5732	SCREW	VIS	SCHRAUBE	TORNILLO
77		-	-	ROSETTA M5 DIN 6798/A	LOCK WASHER	RONDELLE	ZAHNSCHEIBE	ARANDELA DENTADA
78		-	-	ROSETTA M6 DIN 6798/A	LOCK WASHER	RONDELLE	ZAHNSCHEIBE	ARANDELA DENTADA
79		-	-	ROSETTA M8 D.18 UNI 6593	WASHER	RONDELLE	SCHEIBE	ARANDELA
80		-	-	VITE M6X10 UNI 5739 A2	SCREW	VIS	SCHRAUBE	TORNILLO
81		-	-	VITE M5X16 UNI 5739	SCREW	VIS	SCHRAUBE	TORNILLO
82		-	-	ROSETTA M4 D.12 UNI 6593	WASHER	RONDELLE	SCHEIBE	ARANDELA
83		-	-	DADO M4 AUTOBL. UNI 7474	LOCK NUT	ECROU AUTOBLOQUANT	STOPMUTTER	TUERCA AUTOBLOCANTE
84		-	-	DADO M6 UNI 5588 A2	NUT	ECROU	MUTTER	TUERCA
85		-	-	VITE M4X16 UNI 6109	SCREW	VIS	SCHRAUBE	TORNILLO
86		-	-	VITE M8X45 UNI 5739	SCREW	VIS	SCHRAUBE	TORNILLO
87		-	-	DADO M8 UNI 5588	NUT	ECROU	MUTTER	TUERCA
88		-	-	ROSETTA M8 D.24 UNI 6593	WASHER	RONDELLE	SCHEIBE	ARANDELA
89		-	-	VITE M8X40 UNI 5739	SCREW	VIS	SCHRAUBE	TORNILLO
90		-	-	VITE M8X30 UNI 5739	SCREW	VIS	SCHRAUBE	TORNILLO

* = INDY LINE

GRUPPO BASAMENTO SPAZZOLE 50 BS-BTS
BRUSHES BASE ASSEMBLY 50 BS-BTS
GROUPE PLATEAU DES BROSSES 50 BS-BTS
GRUPPE BÜRSTENGESTELL 50 BS-BTS
GRUPO BANCADA CEPILLOS 50 BS-BTS

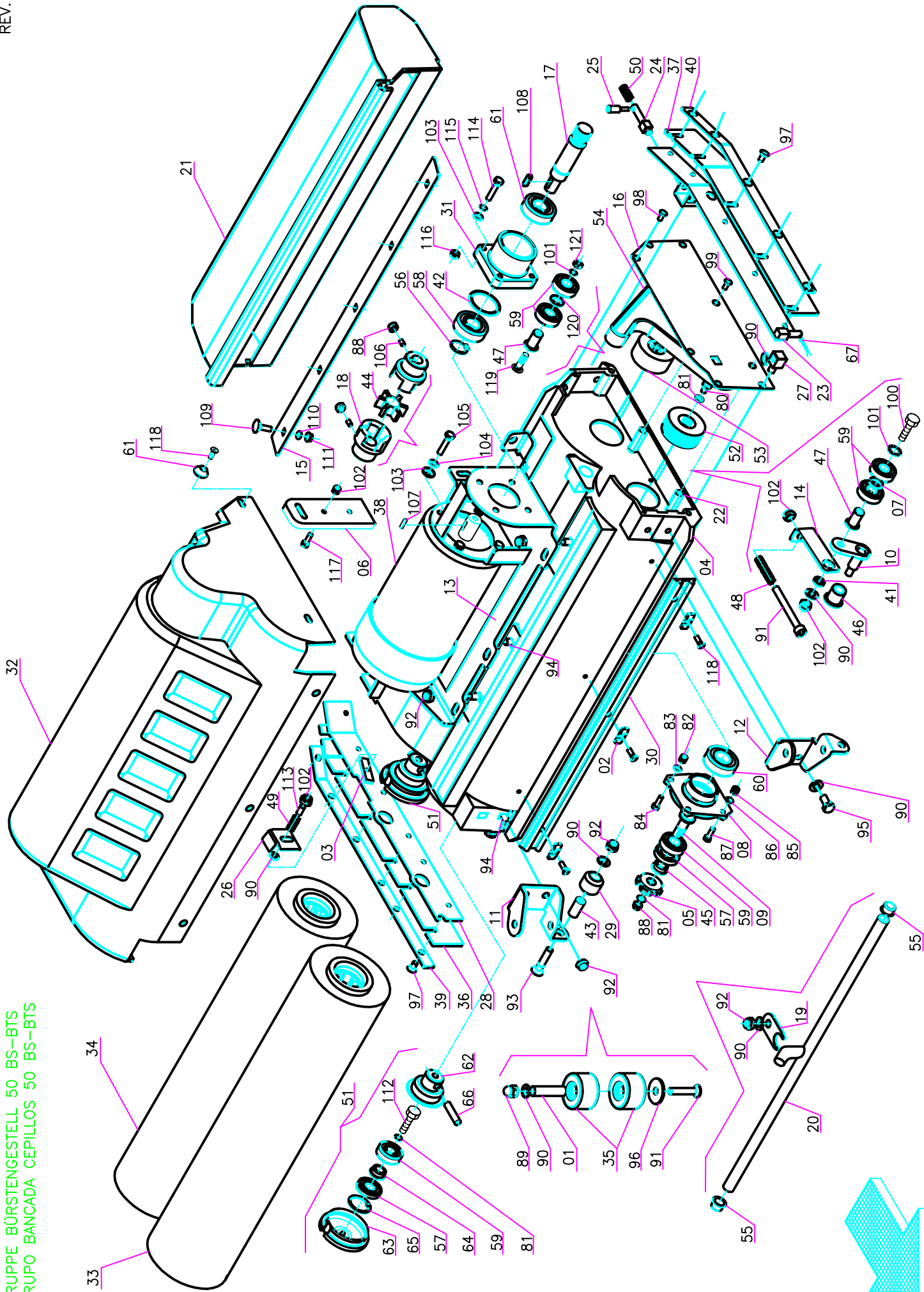

TAV.01C rev.00 GRUPPO BASAMENTO SPAZZOLE 50 BS-BTS

Pos.	Mod.	Codice	Q.tà	Denominazione	Denomination	Description	Benennung	Description
01		203346	2	TUBETTO	PIPE	TUBE	ROHR	TUBO
02		400689	3	PIASTRINA	PLAQUE	PLAQUETTE	BEFESTIGUNGSAUFLAGE	PLAQUETA
03		206519	1	GALLETTO TUNNEL	WING NUT TUNNEL	PAPILLON CARTER BALAI	FLÜGELSCHRAUBE TUNNEL	POMO TUNNEL
04		203533	1	MOZZO TRASCINATORE SINISTRO	LEFT HUB	MOYEU GAUCHE	NABE LINKS	CUBO IZQUIERDO
05		400821	2	PIASTRA	PLAQUE	PLAQUETTE	BEFESTIGUNGSAUFLAGE	PLAQUETA
06		203532	1	RONDELLA 12X18X2 OTTONE	WASHER BRASS	RONDELLE LAITON	UNTERLAGSCHIBE MESSING	ARANDELA LATON
07		409208	2	SUPPORTO CUSCINETTO SX	BEARING SUPPORT	SUPPORT ROULEMENT	LAGERHALTERUNG	SOPORTE COJINETE
08		400824	2	ALBERO DENTATO SX	SHAFT LEFT	ARBRE GAUCHE	WELLE LINKS	EJE IZQUIERDO
09		400825	2	BRACCIO TENDICINGHIA	ARM	BRAS	ARM	BRAZO
10		206798	1	SUPPORTO RUOTE DX	SUPPORT WHEELS	SUPPORT ROUES	HALTERUNG RÄDER	SOPORTE RUEDAS
11		203534	1	SUPPORTO RUOTE SX	SUPPORT WHEELS	SUPPORT ROUES	HALTERUNG RÄDER	SOPORTE RUEDAS
12		203535	1	SUPPORTO MOTORE	MOTOR SUPPORT	SUPPORT DE MOTEUR	MOTORHALTERUNG	SOPORTE DE MOTOR
13		206799	1	TIRANTE TENDICINGHIA	TIE ROD	TIGE	SPANNSTANGE	TIRANTE
14		203536	1	LAMA POST. TUNNEL	BLADE	PLAQUE	PLATTE	LISTON
15		400826	1	CARTER SX PULEGGE	COVER	CARTER	ABDECKUNG	CARTER
16		400827	1	ALBERO PULEGGIA MOTORE	SHAFT	ARBRE	WELLE	EJE
17		206800	1	MOZZO GIUNTO ALLUM.	HUB	MOYEU	NABE	CUBO
18		203537	2	PIASTRINA FISSAGGIO TUBO	STOP	ARRET	STOPBELEG	PLAQUETA DE SUJECION
19		400828	1	TUBO DISTRIBUZIONE	PIPE	TUBE	ROHR	TUBO
20		400829	1	CASSA DI RACCOLTA	HOPPER	BAC A DECHETS	SCHMUTZBEHÄLTER	CAJON DE RECOLECCION
21		400830	1	COLONNETTA M5	STUD BOLT	TIGE	GEWINDEBOLZEN	PRISONERO
22		400831	2	SUPPORTO PARASPRUZZI SX	SUPPORT	SUPPORT	HALTERUNG	SOPORTE
23		206801	1	PERNO AGGANCI	PIN	AXE	BOLZEN	PERNO
24		206802	1	PERNO	PIN	AXE	BOLZEN	PERNO
25		400832	1	LAMA SCORREVOLE	LEVER	LEVIER	HEBEL	PALANCA
26		400833	1	ATTACCO SUPPORTO PARASP. SX	COUPLING	ATTAQUE	KUPPLUNG	ACOPLAMIENTO
27		206803	1	SUPPORTO PARASPRUZZI DX	SUPPORT	SUPPORT	HALTERUNG	SOPORTE
28		400834	1	RUOTA D.25	WHEEL	ROUE	RAD	RUEDA
29		400835	2	PARAURTI	BUMPER	PARE-CHOCS	STOSSDAMPFER	PARACHOQUES
30		203544	1	SUPPORTO CUSCINETTI	SUPPORT	SUPPORT	HALTERUNG	SOPORTE
31		400845	1	CARTER	COVER	CARTER	ABDECKUNG	CARTER
32		415158	1	SPAZZOLA ANTERIORE	FRONT BRUSH	BROSSE AVANT	VORDERE WALZE	CEPILLO DELANTERA
33		-	1	SPAZZOLA POSTERIORE	REAR BRUSH	BROSSE ARRIERE	HINTERE WALZE	CEPILLO TRASERO
34		-	1	RUOTA PARACOLPI	WHEEL	ROUE	RAD	RUEDA
35		405707	4	PARASPRUZZI DX	SPLASH GUARD	BAVETTE DE PROTECTION	SPRITZGUMMI	PARASALPICADURAS
36		406050	1	PARASPRUZZI SX	SPLASH GUARD	BAVETTE DE PROTECTION	SPRITZGUMMI	PARASALPICADURAS
37		406051	1	MOTORE 24V 600W	MOTOR	MOTEUR	MOTOR	MOTOR
38		407717	1	LAMA PREMIGOMMA DX	RIGHT BLADE	PLAQUETTE DROITE	RECHTE LEISTE	LISTON DERECHO
39		407956	1	LAMA PREMIGOMMA SN	LEFT BLADE	PLAQUETTE GAUCHE	LINKE LEISTE	LISTON IZQUIERDO
40		407957	1	DISTANZIALE 8X14X3.5	SPACER	ENTRETOISE	DISTANZHÜLSE	DISTANCIADOR
41		407991	1	DISTANZIALE 35X42X2	SPACER	ENTRETOISE	DISTANZHÜLSE	DISTANCIADOR
42		202449	1	BOCCOLA	BUSHING	BAGUE	BUCHSE	CASQUILLO
43		408021	2					

GRUPPO BASAMENTO SPAZZOLE 50 BS-BTS
 BRUSHES BASE ASSEMBLY 50 BS-BTS
 GROUPE PLATEAU DES BROSSES 50 BS-BTS
 GRUPPE BÜRSTENGESTELL 50 BS-BTS
 GRUPO BANCADA CEPILLOS 50 BS-BTS

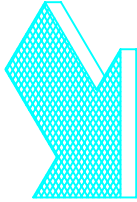
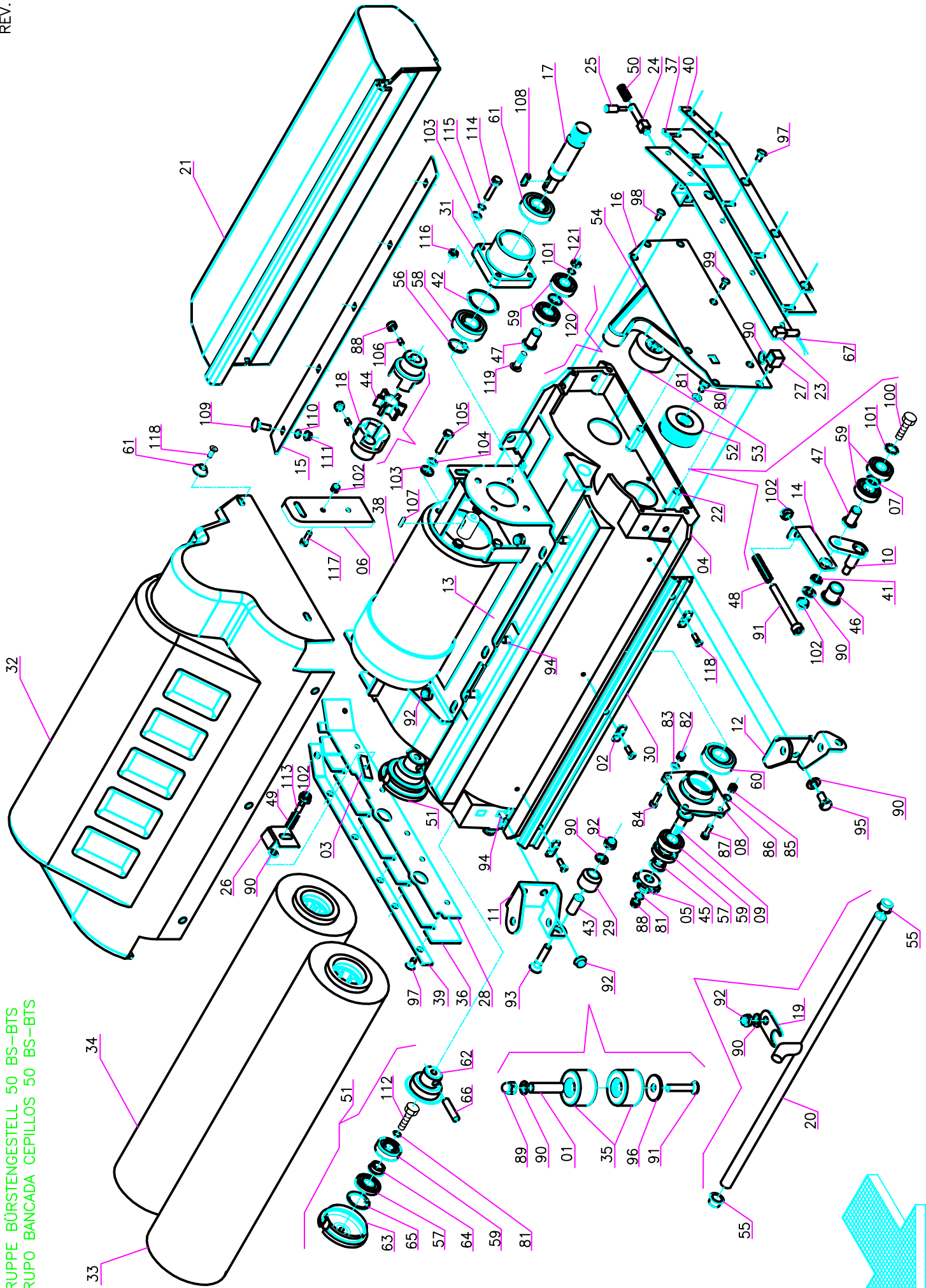

TAV.01C

rev.00

GRUPPO BASAMENTO SPAZZOLE 50 BS-BTS

Pos.	Mod.	Codice	Q.tà	Denominazione	Denomination	Description	Benennung	Description
44		410561	1	ANELLO IN GOMMA PER GIUNTO	RUBBER ROW	ANNEAU	GUMMIRING	ANILLO DE GOMA
45		210199	2	BOCCOLA ALBERO SN	BUSHING	BAGUE	BUCHSE	CASQUILLO
46		408089	1	BOCCOLA BRACCIO TERGI	BUSHING	BAGUE	BUCHSE	CASQUILLO
47		210200	2	BOCCOLA	BUSHING	BAGUE	BUCHSE	CASQUILLO
48		210206	1	MOLLA COMPRESSIONE	SPRING	RESSORT	FEDER	RESORTE
49		408107	1	MOLLA COMP. INOX	SPRING	RESSORT	FEDER	RESORTE
50		408108	1	MOLLA COMP. INOX	SPRING	RESSORT	FEDER	RESORTE
51		200154	1	MOZZO DESTRO COMPLETO	RIGHT HUB ASSY	MOYEU DROITE	NABE RECHTS	CUBO DERECHO
52		408160	1	PULEGGIA RIGATA	PULLEY	POULIE	RIEMENSCHLEIBE	PULEA
53		408162	1	PULEGGIA LISCIA	PULLEY	POULIE	RIEMENSCHLEIBE	PULEA
54		408322	1	CINGHIA PV J8 660	BELT	COURROIE	RIEMEN	CORREA
55		T2913002	2	TAPPO	COVER	COUVERCLE	DECKEL	TAPA
56		408356	1	SEEGER E20	SEEGER RING	SERRE CLIPS	SEEGERRING	ANILLO SEEGER
57		407608	4	PARAOLIO DIAM.17X32X5	OIL SEAL	JOINT PAULSTRA	SIMMERING	ARO RASCADOR DE ACEITE
58		408434	2	CUSCINETTO SF.6004-2RS	BEARING	ROULEMENT	LAGER	COJINETE
59		408422	8	CUSCINETTO 6201-2RS	BEARING	ROULEMENT	LAGER	COJINETE
60		408427	2	CUSCINETTO SF.6202-2RS	BEARING	ROULEMENT	LAGER	COJINETE
61		400250	4	RONDELLA SPECIALE	SPECIAL WASHER	RONDELLE SPACIALE	UNTERLAGSCHEIBE SPEZIAL	ARANDELA SPECIAL
62		400822	2	MOZZO DX FOLLE	RIGHT HUB	MOYEU DROITE	NABE RECHTS	CUBO DERECHO
63		400823	2	MOZZO DX FISSO	RIGHT HUB	MOYEU DROITE	NABE RECHTS	CUBO DERECHO
64		210198	2	BOCCOLA MOZZO DX	BUSHING	BAGUE	BUCHSE	CASQUILLO
65		408338	2	SEEGER INT. 32 UNI 7437 C 70	SEEGER	SEEGER	SEEGER	SEEGER
66		409380	2	SPINA CIL. Ø 8x3.5 INOX	SPRING PIN	FOURCHETTE	SPANNSTIFT	PASADOR
67		409383	1	COPIGLIA 2x20 UNI 1336 INOX	SPLIT PIN	GOUPILLE	SPLINT	PASADOR DE ALETAS
80		-	-	VITE M6x10 TE UNI 5739 ZINC.	SCREW	VIS	SCHRAUBE	TORNILLO
81		-	-	RONDELLA BOMB. D.6.1x18x1 DENT.	WASHER	RONDELLE	SCHEIBE	ARANDELA
82		-	-	DADO M4 UNI 7473	NUT	ECROU	MUTTER	TUERCA
83		-	-	RONDELLA M4 UNI 6592 INOX	WASHER	RONDELLE	SCHEIBE	ARANDELA
84		-	-	VITE M4x16 TE UNI 5739 A2	SCREW	VIS	SCHRAUBE	TORNILLO
85		-	-	DADO M5 UNI 7473 A2	NUT	ECROU	MUTTER	TUERCA
86		-	-	RONDELLA M5 UNI 6592 INOX	WASHER	RONDELLE	SCHEIBE	ARANDELA
87		-	-	VITE M5x16 TE UNI 5739 A2	SCREW	VIS	SCHRAUBE	TORNILLO
88		-	-	DADO M6 AUTOBL. UNI 7473 ZINC.	LOCK NUT	ECROU AUTOBLOQUANT	STOPMUTTER	TUERCA AUTOBLOCANTE
89		-	-	DADO M8 CIECO UNI 5722	NUT	ECROU	MUTTER	TUERCA
90		-	-	ROSETTA M8 UNI 6592 ZINC.	WASHER	RONDELLE	SCHEIBE	ARANDELA
91		-	-	VITE M8x70 TPSEI UNI 5933 ZINC.	SCREW	VIS	SCHRAUBE	TORNILLO
92		-	-	DADO AUTOBL. M8 UNI 7473 ZINC.	LOCK NUT	ECROU AUTOBLOQUANT	STOPMUTTER	TUERCA AUTOBLOCANTE
93		-	-	VITE M8x40 TPSEI UNI 5933 ZINC.	SCREW	VIS	SCHRAUBE	TORNILLO
94		-	-	VITE M8x25 TTQST UNI 5731-65 A2	SCREW	VIS	SCHRAUBE	TORNILLO
95		-	-	VITE M8x25 TE	SCREW	VIS	SCHRAUBE	TORNILLO
96		-	-	ROSETTA M8 D.32 UNI 6593 ZINC.	WASHER	RONDELLE	SCHEIBE	ARANDELA
97		-	-	VITE M6x12 TPSEI UNI 5933 A2	SCREW	VIS	SCHRAUBE	TORNILLO
98		-	-	VITE M5x12 TPSEI UNI 5933 A2	SCREW	VIS	SCHRAUBE	TORNILLO

Pos.	Mod.	Codice	Q.tà	Denominazione	Denomination	Description	Benennung	Description
99	-	VITE M5x25	-	SCREW	SCREW	VIS	SCHRAUBE	TORNILLO
100	-	VITE M8x45 TE UNI 5739 ZINC.	-	SCREW	SCREW	VIS	SCHRAUBE	TORNILLO
101	-	RONDELLA D.8 DENT.INT. DIN6798/J	-	WASHER	WASHER	RONDELLE	SCHEIBE	ARANDELA
102	-	DADO M8 UNI 5588 ZINC.	-	NUT	NUT	ECROU	MUTTER	TUERCA
103	-	ROSETTA M6 UNI 1751 ZINC.	-	WASHER	WASHER	RONDELLE	SCHEIBE	ARANDELA
104	-	ROSETTA M6 D.18 UNI 6593 ZINC.	-	WASHER	WASHER	RONDELLE	SCHEIBE	ARANDELA
105	-	VITE M6x30 TE UNI 5739 ZINC.	-	SCREW	SCREW	VIS	SCHRAUBE	TORNILLO
106	-	GRANO M6x16 EI UNI 5929 A COPPA	-	GRUB SCREW	GRUB SCREW	VIS	MAD ENSCHRAUBE	TORNILLO
107	-	LINGUETTA 5x5x20 UNI 6604/A	-	KEY	KEY	CLAVETTE	KEIL	CLAVIJA
108	-	CHIAVETTA 5x5x18	-	KEY	KEY	CLEVETTE	KEIL	CLAVIJA
109	-	VITE M6x20 TTQST UNI 5732 INOX	-	SCREW	SCREW	VIS	SCHRAUBE	TORNILLO
110	-	RONDELLA M6 D.12 INOX	-	WASHER	WASHER	RONDELLE	SCHEIBE	ARANDELA
111	-	DADO M6 AUTOB. INOX	-	LOCK NUT	LOCK NUT	EGROU AUTOBLOQUANT	STOPMUTTER	TUERCA AUTOBLOCANTE
112	-	VITE 8x35 TCEI DIN 7984 ZINC.	-	SCREW	SCREW	VIS	SCHRAUBE	TORNILLO
113	-	GRANO M8x25	-	GRUB SCREW	GRUB SCREW	VIS	MAD ENSCHRAUBE	TORNILLO
114	-	VITE 6x30 TE UNI 5739 ZINC.	-	SCREW	SCREW	VIS	SCHRAUBE	TORNILLO
115	-	ROSETTA M6 DENT. DIN 6798/A	-	WASHER	WASHER	RONDELLE	SCHEIBE	ARANDELA
116	-	DADO M6 AUTOB. UNI 7474 ZINC.	-	LOCK NUT	LOCK NUT	EGROU AUTOBLOQUANT	STOPMUTTER	TUERCA AUTOBLOCANTE
117	-	VITE M8x20 UNI 5739 ZINC.	-	SCREW	SCREW	VIS	SCHRAUBE	TORNILLO
118	-	VITE M5x16 TPSEI INOX	-	SCREW	SCREW	VIS	SCHRAUBE	TORNILLO
119	-	VITE M8x35 TTQST UNI 5732-65 A2	-	SCREW	SCREW	VIS	SCHRAUBE	TORNILLO
120	-	ROSETTA 12x18x2 OTTONE	-	WASHER	WASHER	RONDELLE	SCHEIBE	ARANDELA
121	-	DADO M8 UNI 5589 INOX BASSO	-	NUT	NUT	ECROU	MUTTER	TUERCA

GRUPPO SPAZZOLE 452B/502B
 BRUSHES ASSEMBLY 452B/502B
 GROUPE DES BROSSES 452B/502B
 BÜRSTENGESTELL 452B/502B
 GRUPO CEPILLOS 452B/502B

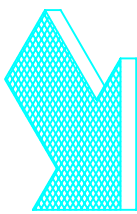
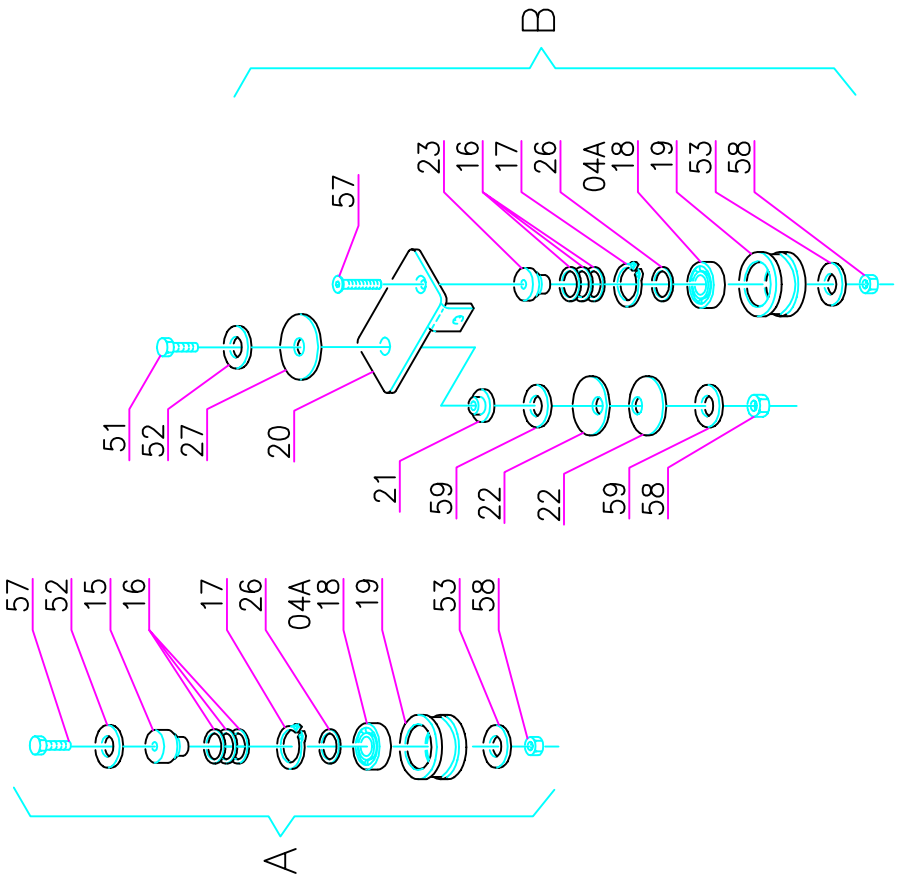
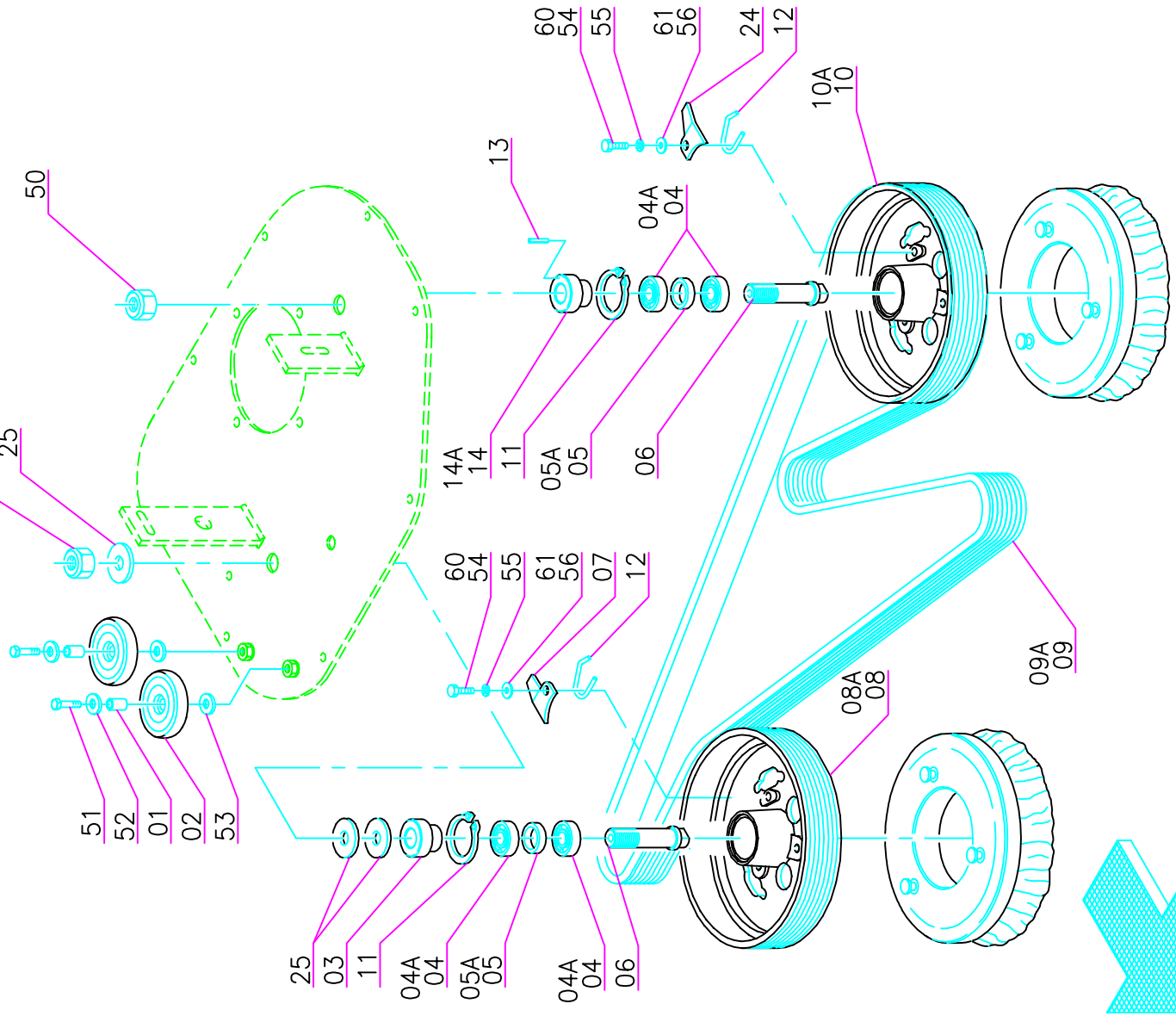
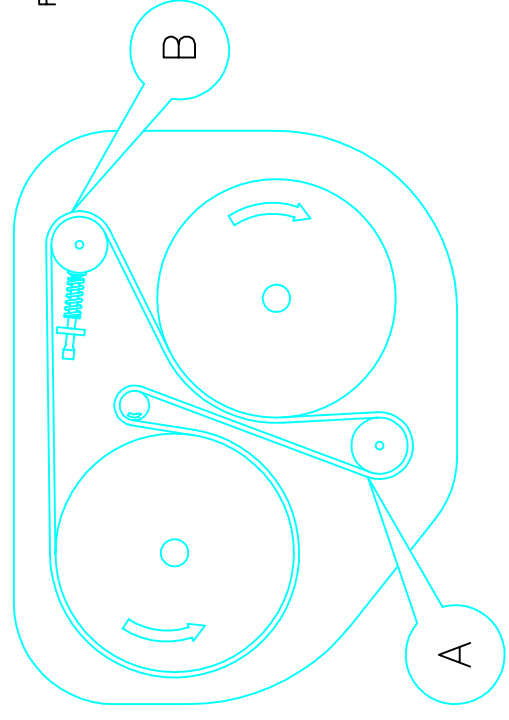

TAV.02 rev.01 GRUPPO SPAZZOLE 452B/502B

Pos.	Mod.	Codice	Q.tà	Denominazione	Denomination	Description	Benennung	Descrizione
1		408021	2	BOCCOLA 8X12X24	BUSHING	BAGUE	BUCHSE	CASQUILLO
2		405708	2	RUOTA PARACOLPI 80X23 NYLON	WHEEL	ROUE	RAD	RUEDA
3		204369	1	DISTANZIALE PER ALBERO DX	SPACER	ENTRETOISE	DISTANZHÜLSE	DISTANCIADOR
4	452B	408434	4	CUSCINETTO A SFERE 6004-2RS1	BEARING	ROULEMENT	LAGER	COJINETE
4A	502B	408435	6	CUSCINETTO A SFERE 6204-2RS1	BEARING	ROULEMENT	LAGER	COJINETE
5	452B	209860	2	DISTANZIALE 20x27x6.2 G42B	SPACER	ENTRETOISE	DISTANZHÜLSE	DISTANCIADOR
5A	502B	210071	2	DISTANZIALE 20x27x8 BAS. G52BT	SPACER	ENTRETOISE	DISTANZHÜLSE	DISTANCIADOR
6		400318	2	ALBERO PORTA SPAZZOLE	SHAFT	ARBRE	LENKWELLE	EJE
7	502B	203281	1	PIASTRINA DI SICUREZZA DX	RIGHT PLATE	PLAQUE DROITE	TELLER RECHTS	PLACA DERECHO
8	452B	210279	1	PULEGGIA TRASC. LISCIA G42 B	PULLEY	POULIE	RIEMENSCHLEIBE	POLEA
8A	502B	210287	1	PULEGGIA TRASC. LISCIA G52B	PULLEY	POULIE	RIEMENSCHLEIBE	POLEA
9	452B	408317	1	CINGHIA POLY V J10-1428	BELT	COURROIE	RIEMEN	CORREA
9A	502B	408318	1	CINGHIA POLY V J10-1651	BELT	COURROIE	RIEMEN	CORREA
10	452B	210252	1	PULEGGIA TRASC. A GOLE G42 B	PULLEY	POULIE	RIEMENSCHLEIBE	POLEA
10A	502B	210262	1	PULEGGIA TRASC. A GOLE G52B	PULLEY	POULIE	RIEMENSCHLEIBE	POLEA
11		408334	2	ANELLO INT. 42 UNI 7437 C70	RING	BAGUE	RING	ANILLO
12		408128	2	MOLLA BLOCCAGGIO SPAZZ. G42/52	SPRING	RESSORT	FEDER	RESORTE
13	452B	409366	1	SPINA ELASTICA 4X10 UNI 6873	ELASTIC PIN	CHEVILLE ELASTIQUE	SPANNSTIFT	ESPIÑA ELASTICA
14	452B	202452	1	DISTANZIALE BASAM. L17	SPACER	ENTRETOISE	DISTANZHÜLSE	DISTANCIADOR
14A	502B	210096	1	DISTANZIALE IN BASAM. G52B	SPACER	ENTRETOISE	DISTANZHÜLSE	DISTANCIADOR
15		204373	1	PERNO TENDICINGHIA FISSO G52	PIN	AXE	BOLZEN	PERNO
16		409240	6	SPESSORE RAM 20x28x0.3 DIN 988	SHIM	EPAISSEUR	BEILAGERING	ESPESOR
17		408335	2	ANELLO INT. 47 UNI 7437 C70	RING	BAGUE	RING	ANILLO
18	452B	408435	2	CUSCINETTO A SFERE 6204-2RS1	BEARING	ROULEMENT	LAGER	COJINETE
19		202519	2	PULEGGIA TENDICINGHIA G52/S.S.	PULLEY	POULIE	RIEMENSCHLEIBE	POLEA
20		203267	1	BRACCIO TENDICINGHIA	ARM	BRAS	ARM	BRAZO
21		408031	1	BOCCOLA 8X15.5X7.5 H=11.5	BUSHING	BAGUE	BUCHSE	CASQUILLO
22		409186	2	MOLLA A TAZZA 8x18x0.8	CUPPED WASHER	RONDELLE CONCAVE	UNTERLAGSCHEIBE	ARANDELA CONCAVA
23	452B	204372	1	PERNO TENDICINGHIA MOBILE G52	PIN	AXE	BOLZEN	PERNO
24	502B	203282	1	PIASTRINA DI SICUREZZA SX	LEFT PLATE	PLAQUE GAUCHE	TELLER LINKS	PLACA IZQUIERDO
25		409226	3	MOLLA A TAZZA 20X40X2	CUPPED WASHER	RONDELLE CONCAVE	UNTERLAGSCHEIBE	ARANDELA CONCAVA
26		409328	2	SPESSORE RAM 37X47X0.3	SHIM	EPAISSEUR	BEILAGERING	ESPESOR
27		400320	1	RONDELLA SPALLAMENTO	WASHER	RONDELLE	SCHLEIBE	ARANDELA
50		-	-	DADO M20 AUTOBL. UNI 7474	LOCK NUT	ECROU AUTOBLOQUANT	STOPMUTTER	TUERCA AUTOBLOCANTE
51		-	-	VITE M8X35 UNI 5739	SCREW	VIS	SCHRAUBE	TORNILLO
52		-	-	ROSETTA M8 UNI 6592	WASHER	RONDELLE	SCHLEIBE	ARANDELA
53		-	-	ROSETTA M8 D.32 UNI 6593	WASHER	RONDELLE	SCHLEIBE	ARANDELA
54	452B	-	-	VITE M4X10 UNI 7687 A2	SCREW	VIS	SCHRAUBE	TORNILLO
55	452B	-	-	ROSETTA M4 DIN 6798/A	LOCK WASHER	RONDELLE	ZAHNSCHLEIBE	ARANDELA DENTADA
56	452B	-	-	ROSETTA M5 D.20 UNI 6593	WASHER	RONDELLE	SCHLEIBE	ARANDELA
57		-	-	VITE M8X50 UNI 5739	SCREW	VIS	SCHRAUBE	TORNILLO
58		-	-	DADO M8 AUTOBL. UNI 7474	LOCK NUT	ECROU AUTOBLOQUANT	STOPMUTTER	TUERCA AUTOBLOCANTE

GRUPPO SPAZZOLE 452B/502B
 BRUSHES ASSEMBLY 452B/502B
 GROUPE DES BROSSES 452B/502B
 BÜRSTENGESTELL 452B/502B
 GRUPO CEPILLOS 452B/502B

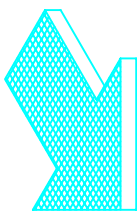
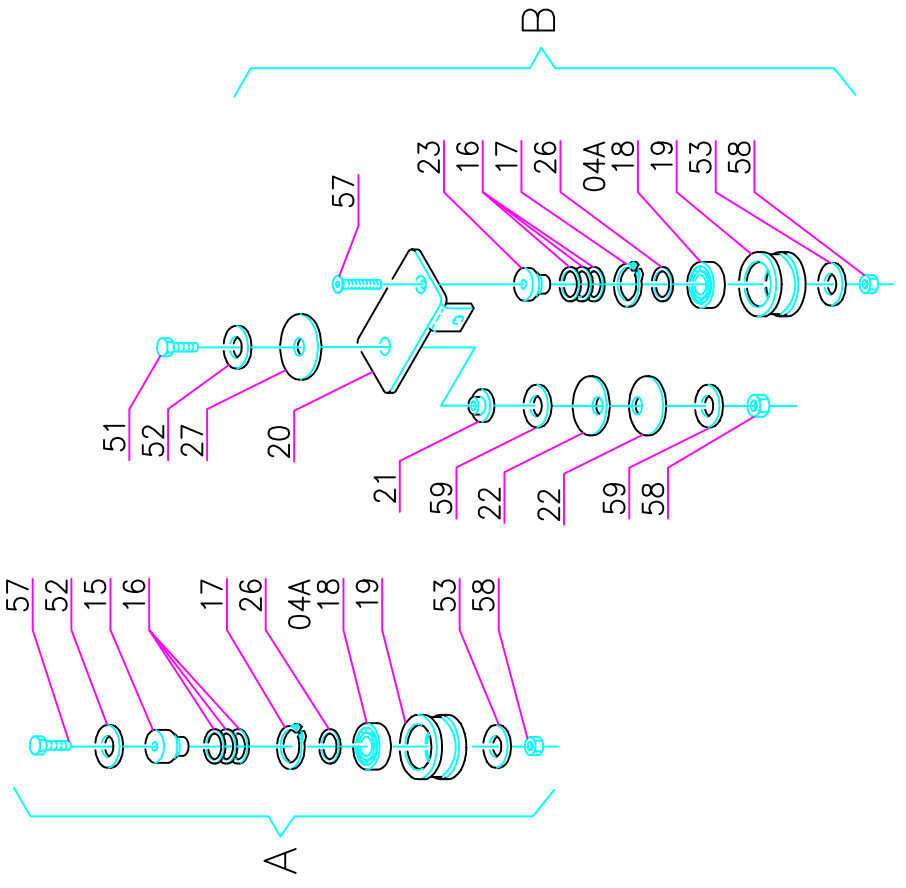
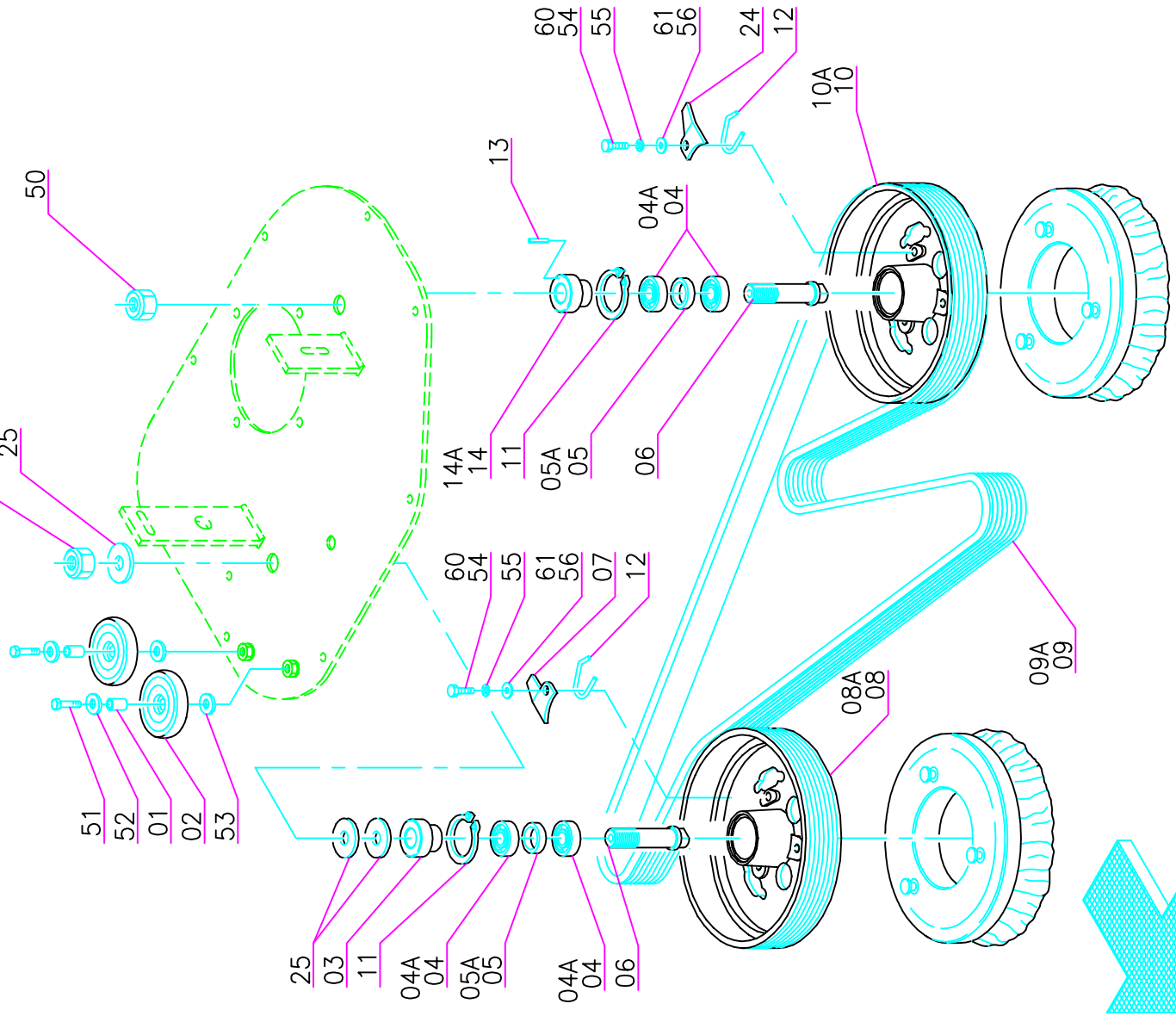
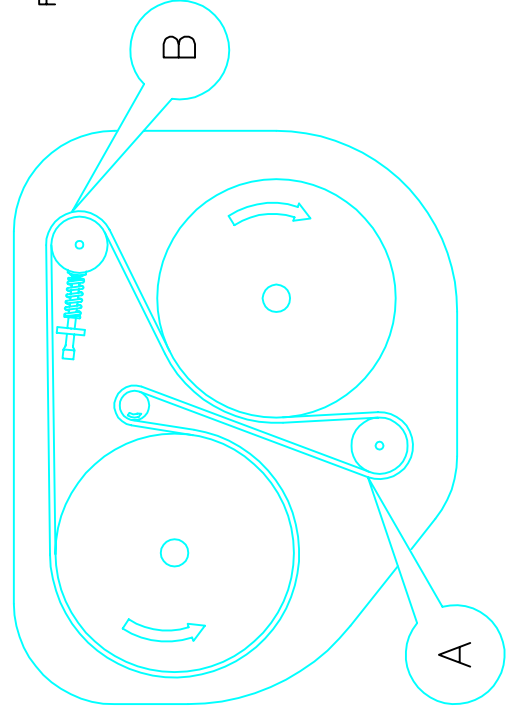

TAV.02 rev.01 GRUPPO SPAZZOLE 452B/502B

Pos.	Mod.	Codice	Q.tà	Denominazione	Denomination	Description	Benennung	Description
59		-	-	ROSETTA M8 D.24 UNI 6593	WASHER	RONDELLE	SCHEIBE	ARANDELA
60	502B	-	-	VITE M8X10 UNI 5739	SCREW	VIS	SCHRAUBE	TORNILLO
61	502B	-	-	ROSETTA M8 D.24 UNI 6593	WASHER	RONDELLE	SCHEIBE	ARANDELA
62	502B	-	-	ROSETTA M20 UNI 65892	WASHER	RONDELLE	SCHEIBE	ARANDELA

GRUPPO SPAZZOLE 452BT/502BT
 BRUSHES ASSEMBLY 452BT/502BT
 GROUPE DES BROSSES 452BT/502BT
 BÜRSTENGESTELL 452BT/502BT
 GRUPO CEPILLOS 452BT/502BT

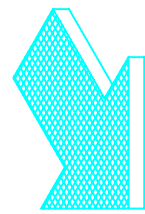
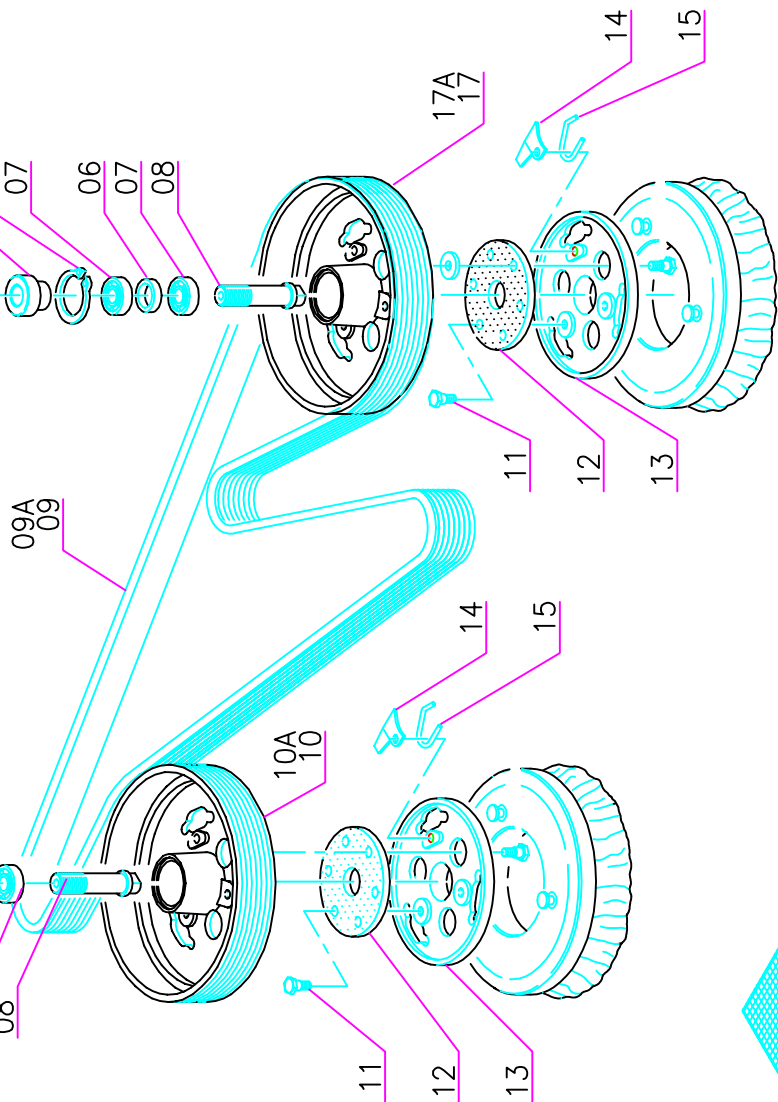
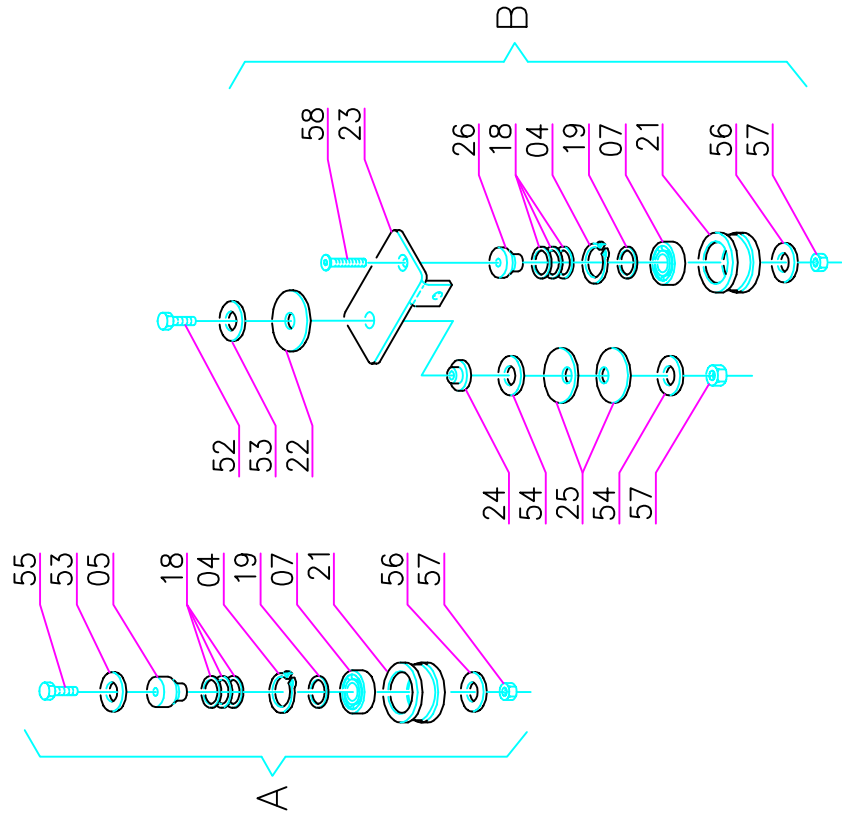
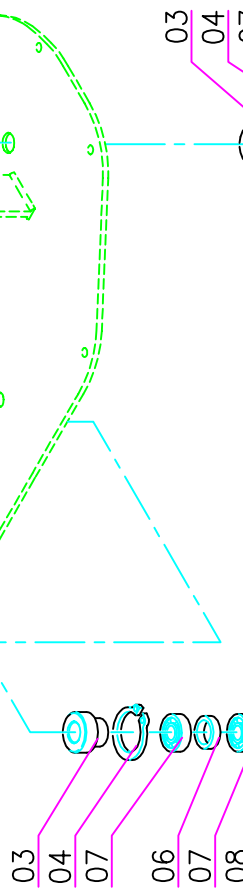
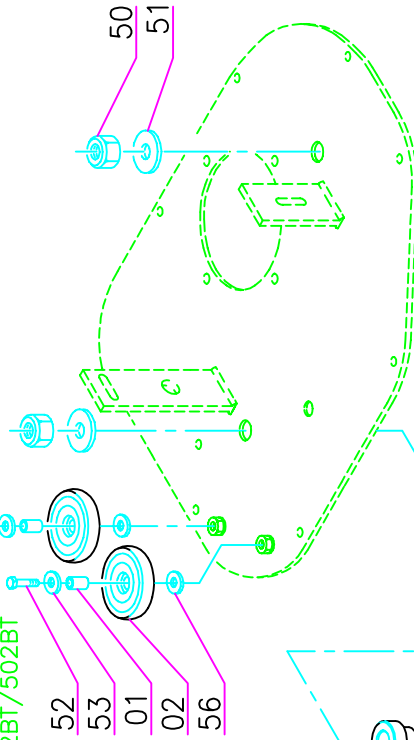
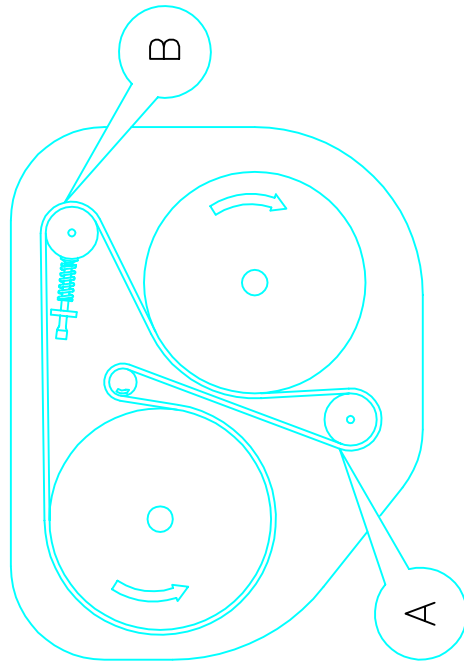

TAV.02A rev.01 GRUPPO SPAZZOLE 452BT/502BT

Pos.	Mod.	Codice	Q.tà	Denominazione	Denomination	Description	Benennung	Description
1		408021	2	BOCCOLA 8X12X24	BUSHING	BAGUE	BUCHSE	CASQUILLO
2		405708	2	RUOTA PARACOLPI 80X23 NYLON	WHEEL	ROUE	RAD	RUEDA
3		204369	2	DISTANZIALE PER ALBERO DX	SPACER	ENTRETOISE	DISTANZHÜLSE	DISTANCIADOR
4		408335	4	ANELLO INT. 47 UNI 7437 C70	RING	BAGUE	RING	ANILLO
5		204373	1	PERNO TENDICINGHIA FISSO G52	PIN	AXE	BOLZEN	PERNO
6		210071	2	DISTANZIALE 20x27x8 BAS. G52BT	SPACER	ENTRETOISE	DISTANZHÜLSE	DISTANCIADOR
7		408435	6	CUSCINETTO A SFERE 6204-2RS1	BEARING	ROULEMENT	LAGER	COJINETE
8		400318	1	ALBERO PORTA SPAZZOLE	SHAFT	ARBRE	LENKWELLE	EJE
9	452BT	408317	1	CINGHIA POLY V J10-1428	BELT	COURROIE	RIEMEN	CORREA
9A	502BT	408318	1	CINGHIA POLY V J10-1651	BELT	COURROIE	RIEMEN	CORREA
10	452BT	210286	1	PULEGGIA TRASC. LISCIA G42BT	PULLEY	POULIE	RIEMENSCHLEIBE	POLEA
10A	502BT	210285	1	PULEGGIA TRASC. LISCIA G52BT	PULLEY	POULIE	RIEMENSCHLEIBE	POLEA
11		203269	12	COLONNETTA PER GIUNTO	STUD BOLT	TIGE	GEWINDEBOLZEN	PRISIONERO
12		400634	2	GIUNTO ELASTICO D.108 T.4 H=8	FLEXIBLE COUPLING	ENTRAINEMENT ELASTIQUE	GUMMIKUPPLUNG	ACOPLAMIENTO ELASTICO
13		400413	2	PIATTO PORTA SPAZZOLA	BRUSH PLATE	PLATEAU DE BROSSSE	BÜRSTENTRÄGER	PLATO PORTACEPILLO
14		203268	2	PIASTRINA DI SICUREZZA G42BT	RIGHT PLATE	PLAQUE DROITE	TELLER RECHTS	PLACA DERECHO
15		408128	2	MOLLA BLOCCAGGIO SPAZZ. G42/52	SPRING	RESSORT	FEDER	RESORTE
17	452BT	210261	1	PULEGGIA TRASC. A GOLE G42BT	PULLEY	POULIE	RIEMENSCHLEIBE	POLEA
17A	502BT	210260	1	PULEGGIA TRASC. A GOLE G52BT	PULLEY	POULIE	RIEMENSCHLEIBE	POLEA
18		409240	6	SPESSORE RAM 20x28x0.3 DIN 988	SHIM	EPAISSEUR	BEILAGERING	ESPESOR
19		409328	2	SPESSORE RAM 37x47x0.3 DIN 998	SHIM	EPAISSEUR	BEILAGERING	ESPESOR
21		202519	2	PULEGGIA TENDICINGHIA G52/S.S.	PULLEY	POULIE	RIEMENSCHLEIBE	POLEA
22		400320	1	RONDELLA SPALLAMENTO	WASHER	RONDELLE	SCHLEIBE	ARANDELA
23		203267	1	BRACCIO TENDICINGHIA	ARM	BRAS	ARM	BRAZO
24		408031	1	BOCCOLA 8X15.5X7.5 H=11.5	BUSHING	BAGUE	BUCHSE	CASQUILLO
25		409186	2	MOLLA A TAZZA 8x18x0.8	CUPPED WASHER	RONDELLE CONCAVE	UNTERLAGSCHEIBE	ARANDELA CONCAVA
26		204372	1	PERNO TENDICINGHIA MOBILE G52	PIN	AXE	BOLZEN	PERNO
50		-	-	DADO M20 AUTOBL. UNI 7474	LOCK NUT	ECROU AUTOBLOQUANT	STOPMUTTER	TUERCA AUTOBLOCANTE
51		-	-	ROSETTA M20 UNI 6592	WASHER	RONDELLE	SCHLEIBE	ARANDELA
52		-	-	VITE M8X35 UNI 5739	SCREW	VIS	SCHRAUBE	TORNILLO
53		-	-	ROSETTA M8 UNI 6592	WASHER	RONDELLE	SCHLEIBE	ARANDELA
54		-	-	ROSETTA M8 D.24 UNI 6593	WASHER	RONDELLE	SCHLEIBE	ARANDELA
55		-	-	VITE M8X45 UNI 5739	SCREW	VIS	SCHRAUBE	TORNILLO
56		-	-	ROSETTA M8 D.32 UNI 6593	WASHER	RONDELLE	SCHLEIBE	ARANDELA
57		-	-	DADO M8 AUTOBL. UNI 7474	LOCK NUT	ECROU AUTOBLOQUANT	STOPMUTTER	TUERCA AUTOBLOCANTE
58		-	-	VITE M8X45 UNI 6739	SCREW	VIS	SCHRAUBE	TORNILLO

GRUPPO RUOTE E TRAZIONE B-BT / BS-BTS
 WHEELS AND TRACTION ASSEMBLY B-BT / BS-BTS
 ENSEMBLE ROUES ET TRACTION B-BT / BS-BTS
 HINTERRAEUER UND ANTRIEBSGRUPPE B-BT / BS-BTS
 GRUPO RUEDAS Y TRACCION B-BT / BS-BTS

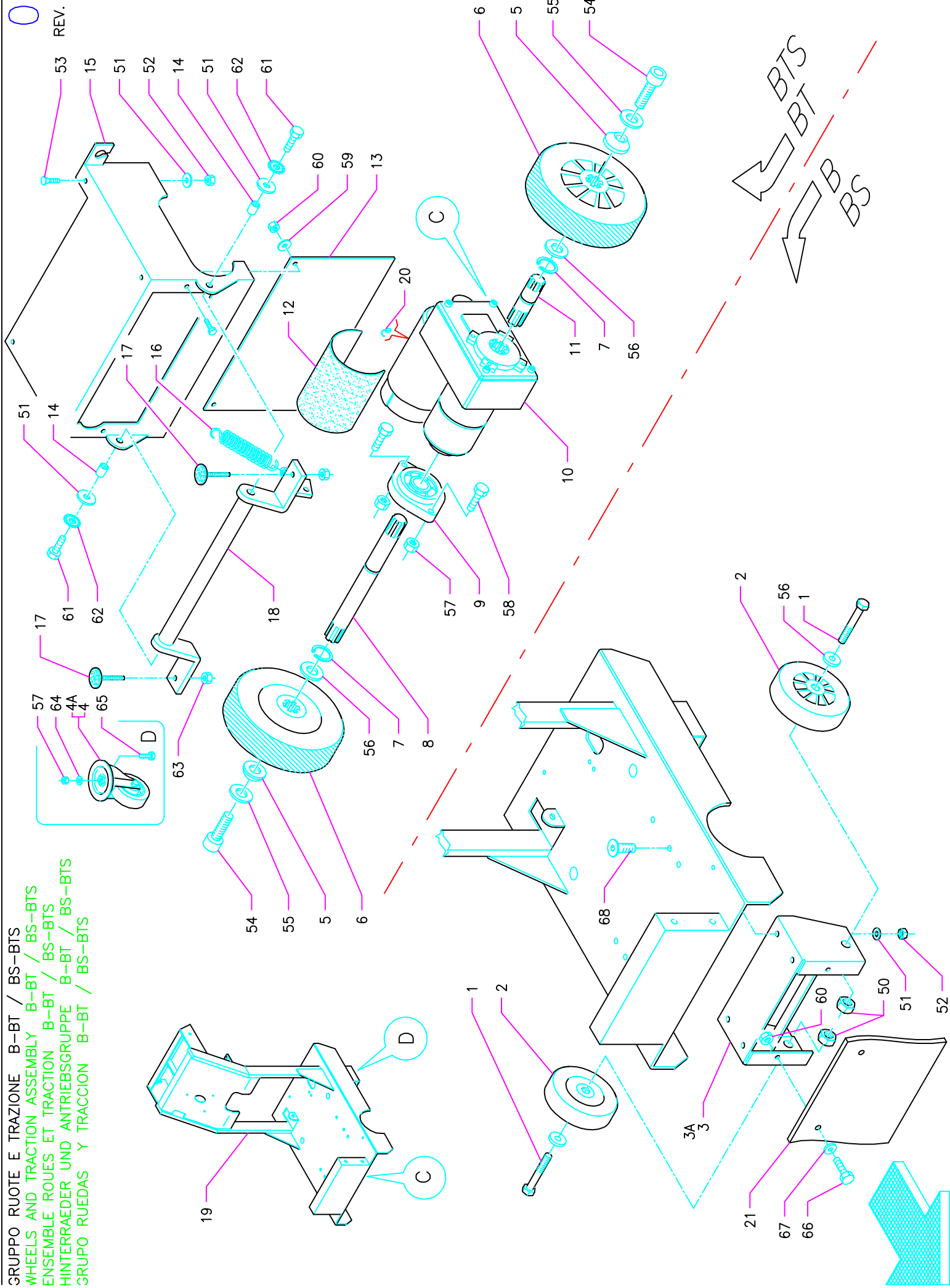

TAV.03 rev.01 GRUPPO RUOTE E TRAZIONE BS-BTS / B-BT

Po	Mod.	Codice	Q.tà	Denominazione	Denomination	Description	Benennung	Description
1	B-BS	203502	2	ASSE RUOTE	CENTRE LINE	AXE	ACHSE	EJE
2	B-BS	414314	2	RUOTA NON TRAZIONE	WHEEL	ROUE	RAD	RUEDA
3	B	203501	1	SUPPORTO RUOTE	SUPPORT	SUPPORT	LAGER	SOPORTE
3A	BS	203541	1	SUPPORTO RUOTE	SUPPORT	SUPPORT	LAGER	SOPORTE
4		405746	2	RUOTA PIVOTTANTE	WHEEL	ROUE	RAD	RUEDA
4A	45 BS-BTS	414332	2	RUOTA PIVOTTANTE	WHEEL	ROUE	RAD	RUEDA
5	BT-BTS	203262	2	RONDELLA RUOTA	WASHER	RONDELLE	SCHEIBE	ARANDELA
6	BT-BTS	405729	2	RUOTA TRAZIONE	WHEEL	ROUE	RAD	RUEDA
7	BT-BTS	408360	2	ANELLO SEEGER E20	SEEGER RING	SERRE CLIPS	SEEGERRING	ANILLO SEEGER
8	BT-BTS	415135	1	SEMIASSE DX	AXLE-SHAFT	DEMI-ASSIEU	ACHSWELLE	SIMI-EJE
9	BT-BTS	415675	1	SUPPORTO	SUPPORT	SUPPORT	LAGER	SOPORTE
10	BT-BTS	414603	1	MOTORIDUTTORE	GEARMOTOR	MOTOREDUCTEUR	REDUZIERGETRIEBE	MOTORIDUCTOR
11	BT-BTS	415136	1	SEMIASSE SX	AXLE-SHAFT	DEMI-ASSIEU	ACHSWELLE	SIMI-EJE
12	BT-BTS	405938	1	CUFFIA MOTORE	SHROUD	JOINT	SAUGMOTORABDECKUNG	ANILLO DEL MOTOR
13	BT-BTS	405975	1	PARASPRUZZI CANTRALE	SPLASH GUARD	BAVETTE	SPRITZGUMMI	PARASALPICADURAS
14	BT-BTS	200325	2	BOCCOLA	BUSHING	DOUILLE	BUCHSE	CASQUILLO
15	BT-BTS	203500	1	SUPPORTO RUOTE	SUPPORT	SUPPORT	LAGER	SOPORTE
16	BT-BTS	202478	1	MOLLA	SPRING	RESSORT	FEDER	RESORTE
17	BT-BTS	204371	2	TAMPONE FRENO	PAD	PATIN	SCHEIBE	ZAPATA
18	BT-BTS	203504	1	ALBERO FRENO	SHAFT	ARBRE	WELLE	EJE
19		202566	1	TELAIO	FRAME	CHASSIS	FAHRGESTELL	BASTIDOR
20		415982	2	SPAZZOLA MOTORE 7X14X19 GM4EC01	CARBON BRUSH MOTOR	CHARBON MOTEUR	KOHLEBURSTE	ESCOBILLA MOTOR
21		405975	1	PARAFLUTTI	SPLASH GUARD	BAVETTE	SPRITZGUMMI	PARASALPICADURAS
50	-	-	-	DADO M16x1.5 AUTOBL UNI 7474	NUT	ECROU	MUTTER	TUERCA
51	-	-	-	RONDELLA M8 UNI 6592	WASHER	RONDELLE	SCHEIBE	ARANDELA
52	-	-	-	DADO M8 AUTOBL. UNI 7474	NUT	ECROU	MUTTER	TUERCA
53	-	-	-	VITE M8x16 UNI 5933	SCREW	VIS	SCHRAUBE	TORNILLO
54	-	-	-	VITE M8x18 UNI 5931	SCREW	VIS	SCHRAUBE	TORNILLO
55	-	-	-	RONDELLA M8 SCHNORR	WASHER	RONDELLE	SCHEIBE	ARANDELA
56	-	-	-	RONDELLA M20 UNI 6592	WASHER	RONDELLE	SCHEIBE	ARANDELA
57	-	-	-	DADO M10 AUTOBL. UNI 7474	NUT	ECROU	MUTTER	TUERCA
58	-	-	-	VITE M10x25 UNI 5739	SCREW	VIS	SCHRAUBE	TORNILLO
59	-	-	-	RONDELLA M6 UNI 6592	WASHER	RONDELLE	SCHEIBE	ARANDELA
60	-	-	-	DADO M6 AUTOBL. UNI 7474	NUT	ECROU	MUTTER	TUERCA
61	-	-	-	VITE M8x20 UNI 5739	SCREW	VIS	SCHRAUBE	TORNILLO
62	-	-	-	RONDELLA M8 DIN 6798/A	WASHER	RONDELLE	SCHEIBE	ARANDELA
63	-	-	-	DADO M8 AUTOBL. UNI 7474	NUT	ECROU	MUTTER	TUERCA
64	-	-	-	RONDELLA M10 UNI 6592	WASHER	RONDELLE	SCHEIBE	ARANDELA
65	-	-	-	VITE M10X35 UNI 5739	SCREW	VIS	SCHRAUBE	TORNILLO
66	-	-	-	VITE M6X16 UNI 5739	SCREW	VIS	SCHRAUBE	TORNILLO
67	-	-	-	ROSETTA M6 D.18 UNI 6593	WASHER	RONDELLE	SCHEIBE	ARANDELA
68	-	-	-	VITE M8X22 UNI 5933	SCREW	VIS	SCHRAUBE	TORNILLO

GRUPPO TERGIPAVIMENTO B-BT / BS-BTS
 SQUEEGEE ASSEMBLY B-BT / BS-BTS
 ENSEMBLE DE SUCEUR B-BT / BS-BTS
 SAUGFUSSGRUPPE B-BT / BS-BTS
 GRUPO LIMPIADORES DE SUELO B-BT / BS-BTS

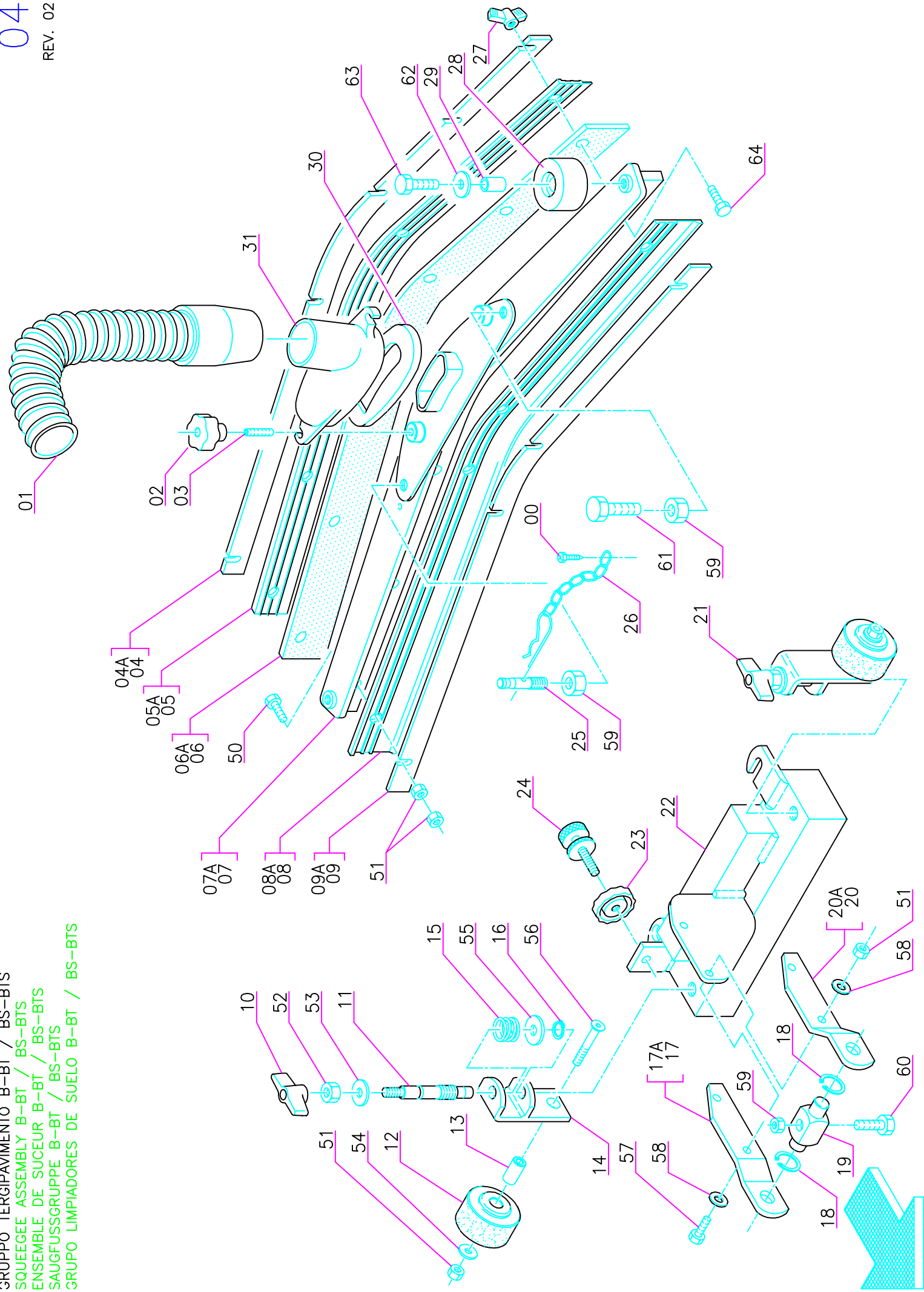

TAV.04 rev.02 GRUPPO TERGIPAVIMENTO B-BT / BS-BTS

Pos.	Mod.	Codice	Q.tà	Denominazione	Denomination	Description	Benennung	Description
1		202166	1	TUBO	PIPE	TUBE	ROHR	TUBE
2		410225	2	POMELLO	KNOB	POMMEAU	KUGELGRIFF	POMO
3		415812	2	GRANO M6x40 EI UNI 5927	DOWEL	VIS	MADENSCHRAUBE	TORNILLO
4	★	202346	1	LAMA PREMIGOMMA POSTERIORE	REAR BLADE	PLAQUETTE ARRIERE	HINTERER LEISTE	LISTON TRASERO
4A	✱	202339	1	LAMA PREMIGOMMA POSTERIORE	REAR BLADE	PLAQUETTE ARRIERE	HINTERER LEISTE	LISTON TRASERO
5	★	202280	1	GOMMA TERGIPAVIMENTO POSTERIORE	REAR RUBBER	BAVETTE ARRIERE	HINTERER SAUGGUMMI	GOMA TRASERA
5A	✱	202277	1	GOMMA TERGIPAVIMENTO POSTERIORE	REAR RUBBER	BAVETTE ARRIERE	HINTERER SAUGGUMMI	GOMA TRASERA
6	★	406234	1	GOMMA TERGIPAVIMENTO CENTRALE	CENTRAL RUBBER	BAVETTE CENTRAL	ZENTRALSAUGGUMMI	GOMA CENTRAL
6A	✱	405498	1	GOMMA TERGIPAVIMENTO CENTRALE	CENTRAL RUBBER	BAVETTE CENTRAL	ZENTRALSAUGGUMMI	GOMA CENTRAL
7	★	202536	1	CORPO TERGIPAVIMENTO	SQUEEGEE BODY	CORPS DE SUCEUR	SAUGFUSSKÖRPER	CUERPO LIMPIAPAVIMENTO
7A	✱	202535	1	CORPO TERGIPAVIMENTO	SQUEEGEE BODY	CORPS DE SUCEUR	SAUGFUSSKÖRPER	CUERPO LIMPIAPAVIMENTO
8	★	202281	1	GOMMA TERGIPAVIMENTO ANTERIORE	FRONT RUBBER	BAVETTE AVANT	VERDERER SAUGGUMMI	GOMA DELANTERA
8A	✱	202276	1	GOMMA TERGIPAVIMENTO ANTERIORE	FRONT RUBBER	BAVETTE AVANT	VERDERER SAUGGUMMI	GOMA DELANTERA
9	★	202345	1	LAMA PREMIGOMMA ANTERIORE	FRONT RUBBER	PLAQUETTE AVANT	VERDERER LEISTE	LISTON DELANTERO
9A	✱	202338	1	LAMA PREMIGOMMA ANTERIORE	FRONT RUBBER	PLAQUETTE AVANT	VERDERER LEISTE	LISTON DELANTERO
10		410237	2	GALLETTO	WING NUT	PAPILLON	FLÜGELSCHRAUBE	POMO
11		400724	2	PERNO REGISTRO RUOTINA	PIN	AXE	BOLZEN	PERNO
12		405682	2	RUOTA	WHEEL	ROUE	RAD	RUEDA
13		407996	2	BOCCOLA PER RUOTE TERGIPAVIMENTO	BUSHING	DOUILLE	BUCHSE	CASQUILLO
14		203289	2	SUPPORTO RUOTINA	SUPPORT	SUPPORT	HALTERUNG	SOPORTE
15		407625	2	MOLLA	SPRING	RESSORT	FEDER	RESSORTE
16		408371	1	ANELLO ELASTICO	RING	ANNEAU	RING	ANILLO
17		203277	1	LAMA ATTACCO TERGIPAVIMENTO DX	BLADE	PLAQUE	PLATTE	LISTON
17A	45BS-BTS	203538	1	LAMA ATTACCO TERGIPAVIMENTO DX	BLADE	PLAQUE	PLATTE	LISTON
18		408373	2	ANELLO ELASTICO	RING	ANNEAU	RING	ANILLO
19		203278	1	SNODO	JOINT	JOINT	GELENK	ARTICULACION
20		203276	1	LAMA ATTACCO TERGIPAVIMENTO SX	BLADE	PLAQUE	PLATTE	LISTON
20A	45BS-BTS	203539	1	LAMA ATTACCO TERGIPAVIMENTO SX	BLADE	PLAQUE	PLATTE	LISTON
21		203067	-	SUPPORTO RUOTINA COMPLETO	WHEEL ASSEMBLY	ROUE COMPLET	RAD KOMPLETT	RUEDA COMPLETA
22		203275	1	ATTACCO TERGIPAVIMENTO	COUPLING	ATTAQUE	KUPPLUNG	SOPORTE
23		400112	1	CONTRODADO	ADJUSTER NUT	ECROU DE REGLAGE	RÄNDELMUTTER	CONTRATUERCA
24		203274	1	REGISTRO	ADJUSTER	REGLAGE	VERSTELLSCHRAUBE	REGULADOR
25		203272	1	COLONNETTA TERGIPAVIMENTO	STUD BOLT	TIGE	GEWINDEBOLZEN	PRISIONERO
26		203273	1	CATENELLA CON SPILLO	CHAIN WITH PIN	CHAINE	KETTE MIT SPLINT	CADENA
27		410231	2	GALLETTO	WING NUT	PAPILLON	FLÜGELSCHRAUBE	POMO
28		405707	2	RUOTA PARACOLPI	WHEEL	ROUE	RAD	RUEDA
29		408033	2	BOCCOLA	BUSHING	BAGUE	BUCHSE	CASQUILLO
30		405954	1	GUARNIZIONE IMBOCCO TERGIPAVIMENTO	GASKET	JOINT	ABDICHTUNG	JUNTA
31		400722	1	BOCCHETTA TERGIPAVIMENTO	OPENING	BUSE	INNENÖFFNUNG	BOQUILLA
50		-	-	VITE M6X20 UNI 5739 A2	SCREW	VIS	SCHRAUBE	TORNILLO
51		-	-	DADO M6 AUTOBL. UNI 7474	LOCK NUT	ECROU AUTOBLOQUANT	STOPMUTTER	TUERCA AUTOBLOCANTE
52		-	-	DADO M6 UNI 5588 A2	NUT	ECROU	MUTTER	TUERCA

GRUPPO TERGIPAVIMENTO B-BT / BS-BTS
 SQUEEGEE ASSEMBLY B-BT / BS-BTS
 ENSEMBLE DE SUCEUR B-BT / BS-BTS
 SAUGFUSSGRUPPE B-BT / BS-BTS
 GRUPO LIMPIADORES DE SUELO B-BT / BS-BTS

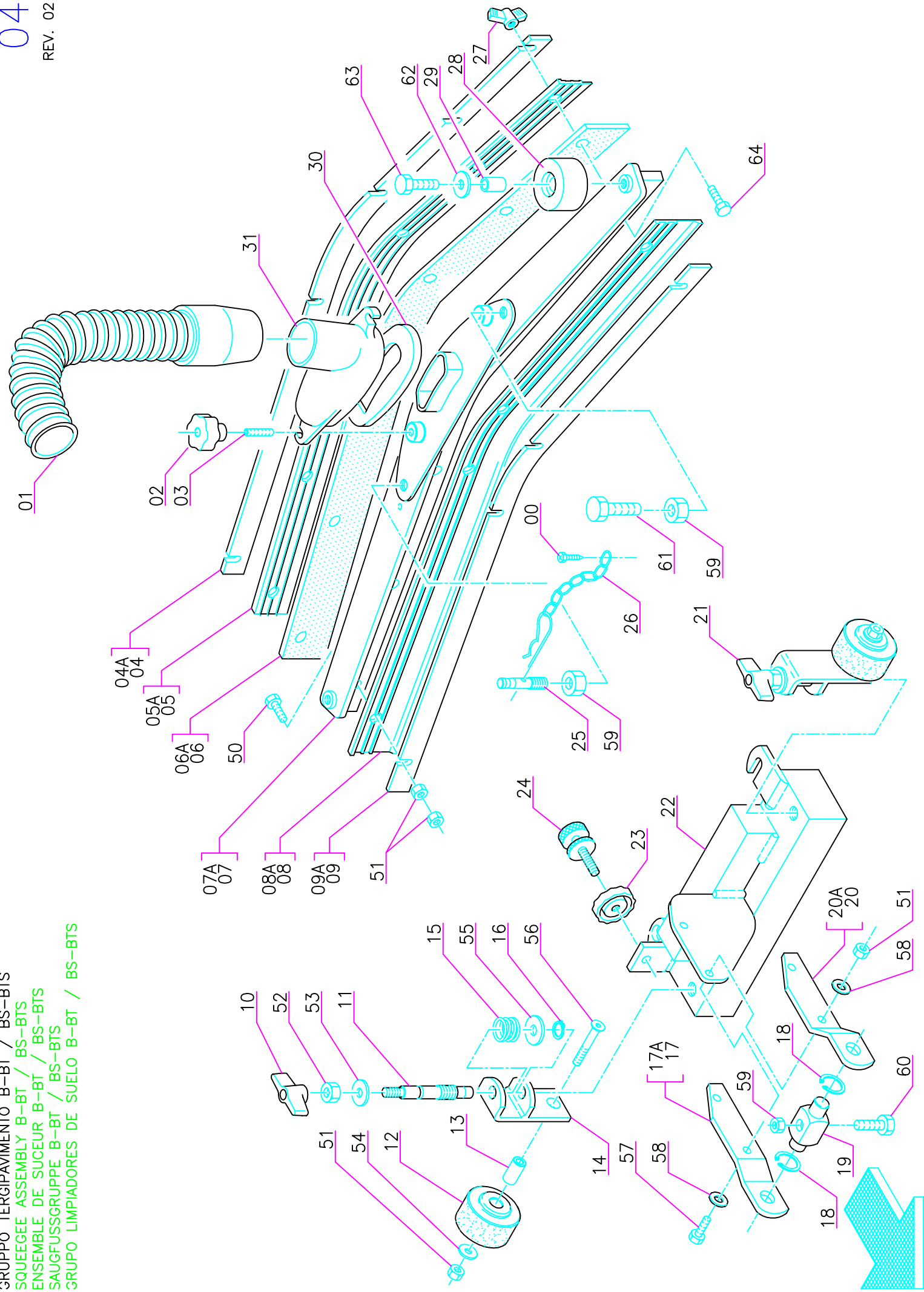

TAV.04 rev.02 GRUPPO TERGIPAVIMENTO B-BT / BS-BTS

Pos.	Mod.	Codice	Q.tà	Denominazione	Denomination	Description	Benennung	Description
53	-	-	-	ROSETTA M6 UNI 6592 OTTONE	WASHER	RONDELLE	SCHEIBE	ARANDELA
54	-	-	-	ROSETTA M6 D.18 UNI 6593	WASHER	RONDELLE	SCHEIBE	ARANDELA
55	-	-	-	ROSETTA M12 UNI 6592	WASHER	RONDELLE	SCHEIBE	ARANDELA
56	-	-	-	VITE M6X50 UNI 5933	SCREW	VIS	SCHRAUBE	TORNILLO
57	-	-	-	VITE M6X25 UNI 5739	SCREW	VIS	SCHRAUBE	TORNILLO
58	-	-	-	ROSETTA M6 UNI 6592	WASHER	RONDELLE	SCHEIBE	ARANDELA
59	-	-	-	DADO M10 UNI 5588	NUT	ECROU	MUTTER	TUERGA
60	-	-	-	VITE M10X50 UNI 5739	SCREW	VIS	SCHRAUBE	TORNILLO
61	-	-	-	VITE M10X25 UNI 5739	SCREW	VIS	SCHRAUBE	TORNILLO
62	-	-	-	ROSETTA M8 UNI 6592	-	-	-	-
63	-	-	-	VITE M8X30 UNI 5739	SCREW	VIS	SCHRAUBE	TORNILLO
64	-	-	-	VITE M6X25 UNI 5933 A2	SCREW	VIS	SCHRAUBE	TORNILLO
-	★	200255	-	TERGIPAVIMENTO COMPLETO	SQUEEGEE ASSEMBLY	ENSEMBLE DE SUCEUR	SAUGFUSSGRUPPE	GRUPO LIMPIADORES DE SUELO
-	✱	200786	-	TERGIPAVIMENTO COMPLETO	SQUEEGEE ASSEMBLY	ENSEMBLE DE SUCEUR	SAUGFUSSGRUPPE	GRUPO LIMPIADORES DE SUELO

★ = 450-452 B-BT

✱ = 500-502 B-BT; 45 BS-BTS

GRUPPO IDRICO 450/500B--BT
 WATER UNIT 450/500B--BT
 GROUPE HIDRIQUE 450/500B--BT
 WASSERGRUPPE 450/500B--BT
 GRUPO AGUA 450/500B--BT

10/2003

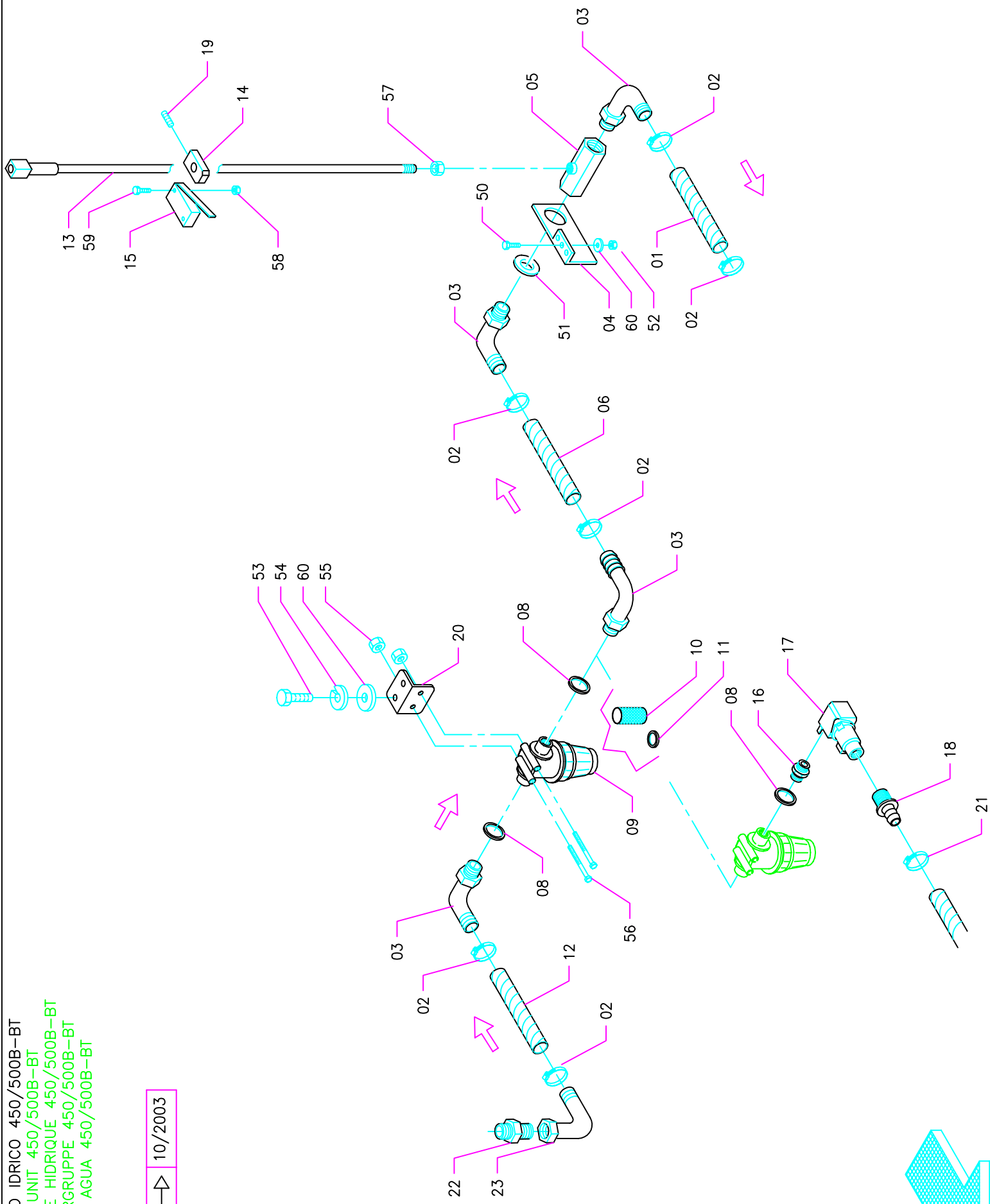

TAV.05 rev.03 GRUPPO IDRICO 450/500B-BT

Pos.	Mod.	Codice	Q.tà	Denominazione	Denomination	Description	Benennung	Description
1		202176	1	TUBO D.14X720 SPIRALATO	TUBE	TUYAU	ROHR	TUBO
2		416172	7	FASCETTA A VITE 16-22	CLAMP	COLLIER	BRIDE	ABRAZADERA
3		410339	3	PORTAGOMMA A GOMITO 1/2x16 M.	CONNECTOR HOSE	RACCORD DE TUYAU	VERBINDUNG-SCHLAUCH	UNION DE TUBO DE GOMA
4		203391	1	STAFFA RUBINETTO	SUPPORT	SUPPORT	HALTERUNG	SOPORTE FIJADOR
5		415110	1	RUBINETTO 1/2	COCK	ROBINET	WASSERHAHN	GRIFO
6		202188	1	TUBO D.14x125 SPIRALATO	TUBE	TUYAU	ROHR	TUBO
7		410371	1	PORTAGOMMA DIRITTO 1/2x16	CONNECTOR	RACCORD	SCHLAUCHANSCHLUSS	EMPALME TUBO DE GOMA
8		408501	2	GUARNIZIONE OR 3068	GASKET	JOINT	ABDICHTUNG	JUNTA
9		405409	1	FILTRO 1/2 F.F. 32 MESH	FILTER	FILTRE	FILTER	FILTRO
10		405410	1	CARTUCCIA	FILTER CARTRIDGE	CARTOUCHE DE FILTRE	FILTEREINSATZ	CARTUCHO FILTRO
11		405959	1	GUARNIZIONE	GASKET	JOINT	ABDICHTUNG	JUNTA
12		202172	1	TUBO D.14x480 SPIRALATO	TUBE	TUYAU	ROHR	TUBO
13		203521	1	ASTA RUBINETTO	ROD	TIGE	STANGE	VARILLA
14		203486	1	MORSETTO PER MICROINT.	CLAMP	BORNE	KLEMME	BORNE
15		409498	1	MICROINTERRUTTORE	MICROSWITCH	MICROINTERRUPTEUR	MIKROSCHALTER	MICROINTERRUPTOR
16	*	416234	1	NIPPOLO MM 3/8-1/2 OTTONE	NIPPLE	RACCORD	NIPPEL	BOQUILLA ROSCADA
17	*	414646	1	ELETTRIVALVOLA COMPLETA 24V	SOLENOID VALVE	ELECTROVANNE ASSY	MAGNETVENTIL COMPLETE	ELECTROVALVULA COMPLETA
18	*	420741	1	PORTAGOMMA DIRITTO 3/8 x13	CONNECTOR	RACCORD	SCHLAUCHANSCHLUSS	EMPALME TUBO DE GOMA
19		415808	1	GRANO M4X8	DOWEL	VIS	MADENSCHRAUBE	TORNILLO
20		203520	1	SUPPORTO FILTRO	SUPPORT	SUPPORT	HALTERUNG	SOPORTE
21	*	410292	1	FASCETTA A VITE 11-17	CLAMP	COLLIER	BRIDE	ABRAZADERA
22		410427	1	NIPLO RIDOTTO	NIPPLE	RACCORD	NIPPEL	BOQUILLA ROSCADA
23		416198	1	PORTAGOMMA A GOMITO	CONNECTOR HOSE	RACCORD DE TUYAU	VERBINDUNG-SCHLAUCH	UNION DE TUBO DE GOMA
50		-	-	VITE M6X16 UNI 5933	SCREW	VIS	SCHRAUBE	TORNILLO
51		-	-	ROSETTA M20 UNI 6592	WASHER	RONDELLE	SCHEIBE	ARANDELA
52		-	-	DADO M6 UNI 5588	NUT	ECROU	MUTTER	TUERCA
53		-	-	VITE M6X20 UNI 5739	SCREW	VIS	SCHRAUBE	TORNILLO
54		-	-	ROSETTA M6 UNI 1751	LOCK WASHER	RONDELLE	ZAHNSCHEIBE	ARANDELA DENTADA
55		-	-	DADO M8 AUTOBL. UNI 7474	LOCK NUT	ECROU AUTOBLOQUANT	STOPMUTTER	TUERCA AUTOBLOCANTE
56		-	-	VITE M8X70 UNI 5737	SCREW	VIS	SCHRAUBE	TORNILLO
57		-	-	DADO M5 UNI 5588	NUT	ECROU	MUTTER	TUERCA
58		-	-	DADO M3 AUTOBL. UNI 7474	LOCK NUT	ECROU AUTOBLOQUANT	STOPMUTTER	TUERCA AUTOBLOCANTE
59		-	-	VITE M3X20 UNI 5739 A2	SCREW	VIS	SCHRAUBE	TORNILLO
60		-	-	ROSETTA M6 UNI 6592	WASHER	RONDELLE	SCHEIBE	ARANDELA

* = PROFY LINE

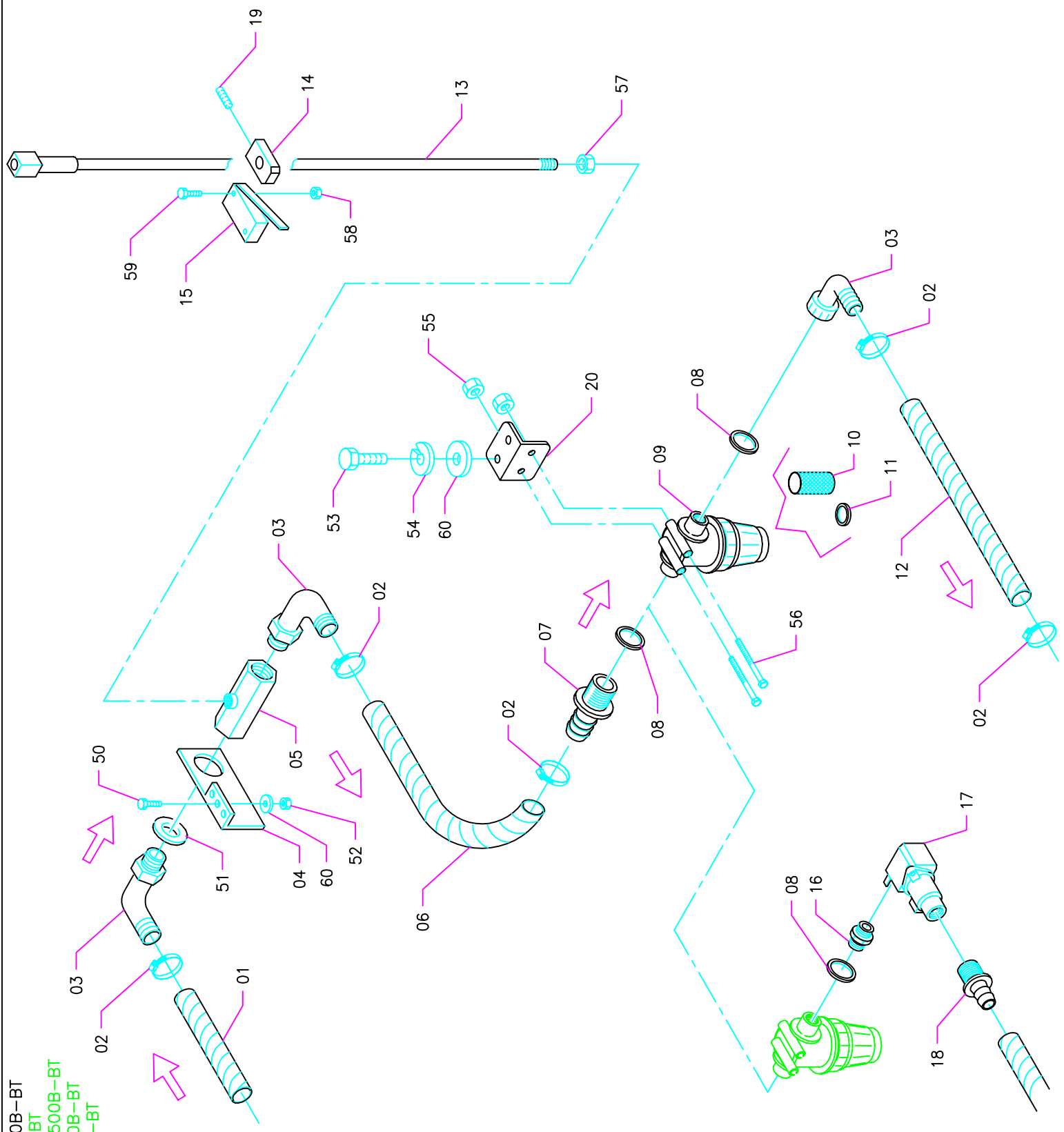

GRUPPO IDRICO 450/500B-BT
 WATER UNIT 450/500B-BT
 GROUPE HIDRIQUE 450/500B-BT
 WASSERGRUPPE 450/500B-BT
 GRUPO AGUA 450/500B-BT

→	05/2000
→	10/2003

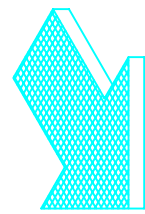

TAV.05A rev.02 GRUPPO IDRICO 450/500B-BT

Pos.	Mod.	Codice	Q.tà	Denominazione	Denomination	Description	Benennung	Description
1		202176	1	TUBO D.14x720 SPIRALATO	TUBE	TUYAU	ROHR	TUBO
2		416172	6	FASCETTA A VITE 16-22	CLAMP	COLLIER	BRIDE	ABRAZADERA
3		410339	3	PORTAGOMMA A GOMITO 1/2x16 M.	CONNECTOR HOSE	RACCORD DE TUYAU	VERBINDUNG-SCHLAUCH	UNION DE TUBO DE GOMA
4		203391	1	STAFFA RUBINETTO	SUPPORT	SUPPORT	HALTERUNG	SOPORTE FIJADOR
5		415110	1	RUBINETTO 1/2	COCK	ROBINET	WASSERHAHN	GRIFO
6		202152	1	TUBO D.14x250 SPIRALATO	TUBE	TUYAU	ROHR	TUBO
7		410371	1	PORTAGOMMA DIRITTO 1/2x16	CONNECTOR	RACCORD	SCHLAUCHANSCHLUSS	EMPALME TUBO DE GOMA
8		408501	2	GUARNIZIONE OR 3068	GASKET	JOINT	ABDICHTUNG	JUNTA
9		405409	1	FILTRO 1/2 F.F. 32 MESH	FILTER	FILTRE	FILTER	FILTRO
10		405410	1	CARTUCCIA	FILTER CARTRIDGE	CARTOUCHE DE FILTRE	FILTEREINSATZ	CARTUJO FILTRO
11		405959	1	GUARNIZIONE	GASKET	JOINT	ABDICHTUNG	JUNTA
12		202158	1	TUBO D.14x550 SPIRALATO	TUBE	TUYAU	ROHR	TUBO
13		203521	1	ASTA RUBINETTO	ROD	TIGE	STANGE	VARILLA
14		203486	1	MORSETTO PER MICROINT.	CLAMP	BORNE	KLEMME	BORNE
15		409498	1	MICROINTERRUTTORE	MICROSWITCH	MICROINTERRUPTEUR	MIKROSCHALTER	MICROINTERRUPTOR
16	*	416234	1	NIPPOLO MM 3/8-1/2 OTTONE	NIPPLE	RACCORD	NIPPEL	BOQUILLA ROSCADA
17	*	414646	1	ELETTROVALVOLA COMPLETA 24V	SOLENOID VALVE	ELECTROVANNE ASSY	MAGNETVENTIL COMPLETE	ELECTROVALVULA COMPLETA
18	*	420741	1	PORTAGOMMA DIRITTO 3/8 x13	CONNECTOR	RACCORD	SCHLAUCHANSCHLUSS	EMPALME TUBO DE GOMA
19		415808	1	GRANO M4X8	DOWEL	VIS	MADENSCHRAUBE	TORNILLO
20		203520	1	SUPPORTO FILTRO	SUPPORT	SUPPORT	HALTERUNG	SOPORTE
50		-	-	VITE M6X16 UNI 5933	SCREW	VIS	SCHRAUBE	TORNILLO
51		-	-	ROSETTA M20 UNI 6592	WASHER	RONDELLE	SCHEIBE	ARANDELA
52		-	-	DADO M6 UNI 5588	NUT	ECROU	MUTTER	TUERCA
53		-	-	VITE M6X20 UNI 5739	SCREW	VIS	SCHRAUBE	TORNILLO
54		-	-	ROSETTA M6 UNI 1751	LOCK WASHER	RONDELLE	ZAHNSCHEIBE	ARANDELA DENTADA
55		-	-	DADO M8 AUTOBL. UNI 7474	LOCK NUT	ECROU AUTOBLOQUANT	STOPMUTTER	TUERCA AUTOBLOCANTE
56		-	-	VITE M8X70 UNI 5737	SCREW	VIS	SCHRAUBE	TORNILLO
57		-	-	DADO M5 UNI 5588	NUT	ECROU	MUTTER	TUERCA
58		-	-	DADO M3 AUTOBL. UNI 7474	LOCK NUT	ECROU AUTOBLOQUANT	STOPMUTTER	TUERCA AUTOBLOCANTE
59		-	-	VITE M3X20 UNI 5739 A2	SCREW	VIS	SCHRAUBE	TORNILLO
60		-	-	ROSETTA M6 UNI 6592	WASHER	RONDELLE	SCHEIBE	ARANDELA

* = PROFY LINE

GRUPPO IDRICO 452/502B-BT
WATER UNIT 452/502B-BT
GROUPE HIDRIQUE 452/502B-BT
WASSERGRUPPE 452/502B-BT
GRUPO AGUA 452/502B-BT

06
REV. 03

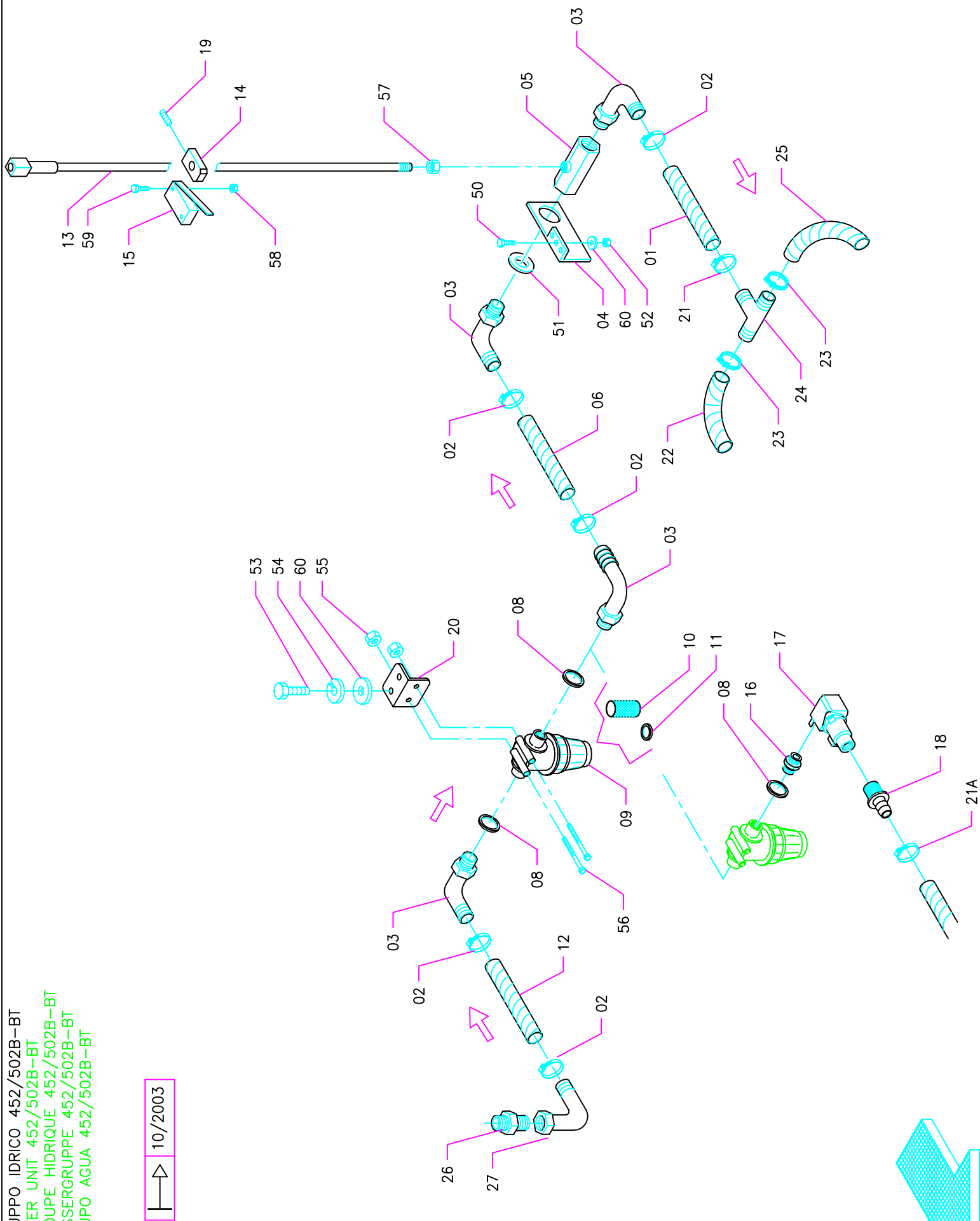

10/2003

Pos.	Mod.	Codice	Q.tà	Denominazione	Denomination	Description	Benennung	Description	Benennung
1		202176	1	TUBO D.14X720 SPIRALATO	TUBE	TUYAU	ROHR	TUBO	TUBO
2		416172	6	FASCETTA A VITE 16-22	CLAMP	COLLIER	BRIDE	ABRAZADERA	ABRAZADERA
3		410339	3	PORTAGOMMA A GOMITO 1/2x16 M.	CONNECTOR HOSE	RACCORD DE TUYAU	VERBINDUNG-SCHLAUCH	UNION DE TUBO DE GOMA	UNION DE TUBO DE GOMA
4		203391	1	STAFFA RUBINETTO	SUPPORT	SUPPORT	HALTERUNG	SOPORTE FIJADOR	SOPORTE FIJADOR
5		415110	1	RUBINETTO 1/2	COCK	ROBINET	WASSERHAHN	GRIFO	GRIFO
6		202188	1	TUBO D.14x125 SPIRALATO	TUBE	TUYAU	ROHR	TUBO	TUBO
7		410371	1	PORTAGOMMA DIRITTO 1/2x16	CONNECTOR	RACCORD	SCHLAUCHANSCHLUSS	EMPALME TUBO DE GOMA	EMPALME TUBO DE GOMA
8		408501	2	GUARNIZIONE OR 3068	GASKET	JOINT	ABDICHTUNG	JUNTA	JUNTA
9		405409	1	FILTRO 1/2 F.F. 32 MESH	FILTER	FILTRE	FILTER	FILTRO	FILTRO
10		405410	1	CARTUCCIA	FILTER CARTRIDGE	CARTOUCHE DE FILTRE	FILTEREINSATZ	CARTUJO FILTRO	CARTUJO FILTRO
11		405959	1	GUARNIZIONE	GASKET	JOINT	ABDICHTUNG	JUNTA	JUNTA
12		202172	1	TUBO D.14x480 SPIRALATO	TUBE	TUYAU	ROHR	TUBO	TUBO
13		203521	1	ASTA RUBINETTO	ROD	TIGE	STANGE	VARILLA	VARILLA
14		203486	1	MORSETTO PER MICROINT.	CLAMP	BORNE	KLEMME	BORNE	BORNE
15		409498	1	MICROINTERRUTTORE	MICROSWITCH	MICROINTERRUPTEUR	MIKROSCHALTER	MICROINTERRUPTOR	MICROINTERRUPTOR
16	*	416234	1	NIPPOLO MM 3/8-1/2 OTTONE	NIPPLE	RACCORD	NIPPEL	BOQUILLA ROSCADA	BOQUILLA ROSCADA
17	*	414646	1	ELETTROVALVOLA COMPLETA 24V	SOLENOID VALVE	ELECTROVANNE ASSY	MAGNETVENTIL COMPLETE	ELETTROVALVOLA COMPLETA	ELETTROVALVOLA COMPLETA
18	*	420741	1	PORTAGOMMA DIRITTO 3/8 x13	CONNECTOR	RACCORD	SCHLAUCHANSCHLUSS	EMPALME TUBO DE GOMA	EMPALME TUBO DE GOMA
19		415808	1	GRANO M4X8	DOWEL	VIS	MADENSCHRAUBE	TORNILLO	TORNILLO
20		203520	1	SUPPORTO FILTRO	SUPPORT	SUPPORT	HALTERUNG	SOPORTE	SOPORTE
21		410292	1	FASCETTA A VITE 11-17	CLAMP	COLLIER	BRIDE	ABRAZADERA	ABRAZADERA
21A	*	410292	1	FASCETTA A VITE 11-17	CLAMP	COLLIER	BRIDE	ABRAZADERA	ABRAZADERA
22		202210	1	TUBO VITREO D.8x200	TUBE	TUYAU	ROHR	TUBO	TUBO
23		410277	2	FASCETTA PLASTICA	CLAMP	COLLIER	BRIDE	ABRAZADERA	ABRAZADERA
24		400658	1	RACCORDO TUBI ACQUA	FITTING	RACCORD	VERSCHRAUBUNG	RACORT	RACORT
25		202209	1	TUBO D.8X300 VITREO	TUBE	TUYAU	ROHR	TUBO	TUBO
26		410427	1	NIPLO RIDOTTO	NIPPLE	RACCORD	NIPPEL	BOQUILLA ROSCADA	BOQUILLA ROSCADA
27		416198	1	PORTAGOMMA A GOMITO	CONNECTOR HOSE	RACCORD DE TUYAU	VERBINDUNG-SCHLAUCH	UNION DE TUBO DE GOMA	UNION DE TUBO DE GOMA
50		-	-	VITE M6X16 UNI 5933	SCREW	VIS	SCHRAUBE	TORNILLO	TORNILLO
51		-	-	ROSETTA M20 UNI 6592	WASHER	RONDELLE	SCHEIBE	ARANDELA	ARANDELA
52		-	-	DADO M6 UNI 5588	NUT	ECROU	MUTTER	TUERCA	TUERCA
53		-	-	VITE M6X20 UNI 5739	SCREW	VIS	SCHRAUBE	TORNILLO	TORNILLO
54		-	-	ROSETTA M6 UNI 1751	LOCK WASHER	RONDELLE	ZAHNSCHEIBE	ARANDELA DENTADA	ARANDELA DENTADA
55		-	-	DADO M8 AUTOBL. UNI 7474	LOCK NUT	ECROU AUTOBLOQUANT	STOPMUTTER	TUERCA AUTOBLOCANTE	TUERCA AUTOBLOCANTE
56		-	-	VITE M8X70 UNI 5737	SCREW	VIS	SCHRAUBE	TORNILLO	TORNILLO
57		-	-	DADO M5 UNI 5588	NUT	ECROU	MUTTER	TUERCA	TUERCA
58		-	-	DADO M3 AUTOBL. UNI 7474	LOCK NUT	ECROU AUTOBLOQUANT	STOPMUTTER	TUERCA AUTOBLOCANTE	TUERCA AUTOBLOCANTE
59		-	-	VITE M3X20 UNI 5739 A2	SCREW	VIS	SCHRAUBE	TORNILLO	TORNILLO
60		-	-	ROSETTA M6 UNI 6592	WASHER	RONDELLE	SCHEIBE	ARANDELA	ARANDELA

* = PROFY LINE

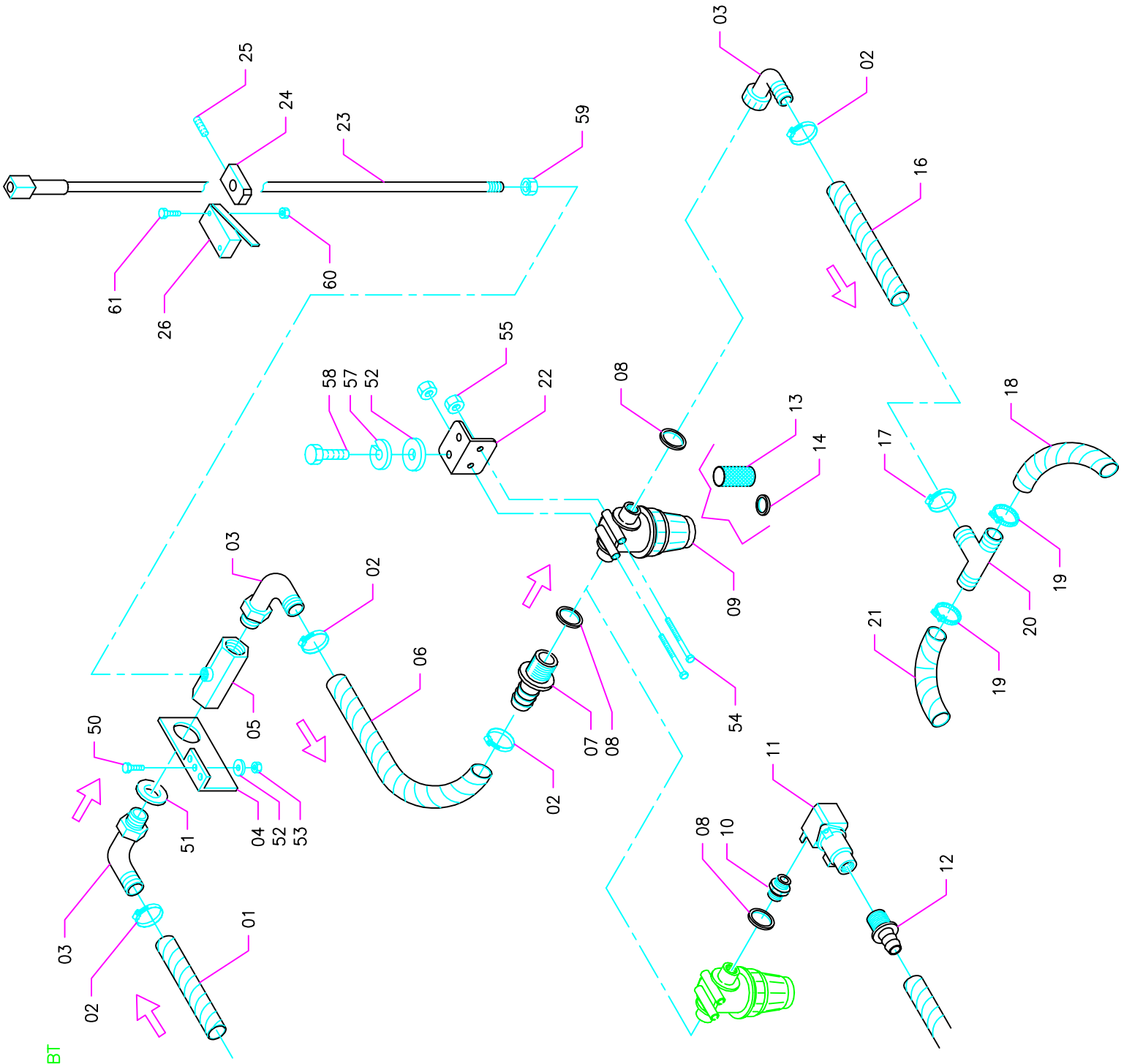

GRUPPO IDRICO 452/502B-BT
 WATER UNIT 452/502B-BT
 GROUPE HIDRIQUE 452/502B-BT
 WASSERGRUPPE 452/502B-BT
 GRUPO AGUA 452/502B-BT

→	05/2000
→	10/2003

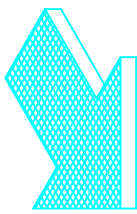

TAV.06A rev.02 GRUPPO IDRICO 452/502B-BT

Pos.	Mod.	Codice	Q.tà	Denominazione	Denomination	Description	Benennung	Description
1		202176	1	TUBO D.14X720 SPIRALATO	TUBE	TUYAU	ROHR	TUBO
2		416172	4	FASCETTA A VITE	CLAMP	COLLIER	BRIDE	ABRAZADERA
3		410339	3	PORTAGOMMA A GOMITO	CONNECTOR HOSE	RACCORD DE TUYAU SOUPLE	VERBINDUNG-SCHLAUCH	UNION DE TUBO DE GOMA
4		203391	1	STAFFA RUBINETTO	SUPPORT	SUPPORT	HALTERUNG	SOPORTE FIJADOR
5		415110	1	RUBINETTO	COCK	ROBINET	WASSERHAHN	GRIFO
6		202152	1	TUBO D.14x250 SPIRALATO	TUBE	TUYAU	ROHR	TUBO
7		410371	1	PORTAGOMMA DIRITTO	CONNECTOR	RACCORD	SCHLAUCHANSCHLUSS	EMPALME TUBO DE GOMA
8		408501	2	GUARNIZIONE OR	GASKET	JOINT	ABDICHTUNG	JUNTA
9		405409	1	FILTRO	FILTER	FILTRE	FILTER	FILTRO
10	*	416234	1	NIPPLO MM 3/8-1/2 OTTONE	NIPPLE	RACCORD	NIPPEL	BOQUILLA ROSCADA
11	*	414646	1	ELETTROVALVOLA COMPL.	SOLENOID VALVE	ELECTROVANNE ASSY	MAGNETVENTIL COMPLETE	ELECTROVALVULA COMPLETA
12	*	420741	1	PORTAGOMMA DIRITTO	CONNECTOR	RACCORD	SCHLAUCHANSCHLUSS	EMPALME TUBO DE GOMA
13		405410	1	CARTUCCIA FILTRO	FILTER CARTRIDGE	CARTOUCHE DE FILTRE	FILTREINSATZ	CARTUCHO FILTRO
14		405959	1	GUARNIZIONE PIANA	GASKET	JOINT	ABDICHTUNG	JUNTA
16		202150	1	TUBO D.14x320 SPIRALATO	TUBE	TUYAU	ROHR	TUBO
17		410292	1	FASCETTA A VITE	CLAMP	COLLIER	BRIDE	ABRAZADERA
18		202209	1	TUBO D.8X300 VITREO	TUBE	TUYAU	ROHR	TUBO
19		410277	2	FASCETTA PLASTICA	CLAMP	COLLIER	BRIDE	ABRAZADERA
20		400658	1	RACCORDO TUBI ACQUA	FITTING	RACCORD	VERSCHRAUBUNG	RACORT
21		202210	1	TUBO D.8X200 VITREO	TUBE	TUYAU	ROHR	TUBO
22		203520	1	SUPPORTO FILTRO	SUPPORT	SUPPORT	HALTERUNG	SOPORTE FIJADOR
23		203521	1	ASTA RUBINETTO	ROD	TIGE	STANGE	VARILLA
24		203486	1	MORSETTO	CLAMP	BORNE	KLEMME	BORNE
25		415808	1	GRANO M4X8	DOWEL	VIS	MADENSCHRAUBE	TORNILLO
26		409498	1	MICROINTERRUTTORE	MICROSWITCH	MICROINTERRUPTEUR	MIKROSCHALTER	MICROINTERRUPTOR
50		-	-	VITE M6X16 UNI 5933	SCREW	VIS	SCHRAUBE	TORNILLO
51		-	-	ROSETTA M20 UNI 6592	WASHER	RONDELLE	SCHEIBE	ARANDELA
52		-	-	ROSETTA M6 UNI 6592	WASHER	RONDELLE	SCHEIBE	ARANDELA
53		-	-	DADO M6 AUTOBL. UNI 7474	LOCK NUT	ECROU AUTOBLOQUANT	STOPMUTTER	TUERCA AUTOBLOCANTE
54		-	-	VITE M8X70 UNI 5737	SCREW	VIS	SCHRAUBE	TORNILLO
55		-	-	DADO M8 AUTOBL. UNI 7474	LOCK NUT	ECROU AUTOBLOQUANT	STOPMUTTER	TUERCA AUTOBLOCANTE
57		-	-	ROSETTA M6 UNI 1751	LOCK WASHER	RONDELLE	ZAHNSCHEIBE	ARANDELA DENTADA
58		-	-	VITE M6X20 UNI 5739	SCREW	VIS	SCHRAUBE	TORNILLO
59		-	-	DADO M5 UNI 5588	NUT	ECROU	MUTTER	TUERCA
60		-	-	DADO M3 AUTOBL. UNI 7474	LOCK NUT	ECROU AUTOBLOQUANT	STOPMUTTER	TUERCA AUTOBLOCANTE
61		-	-	VITE M3X20 UNI 5739 A2	SCREW	VIS	SCHRAUBE	TORNILLO

* = 402-502 PROFY LINE; 502 KLINIK LINE

10/2003

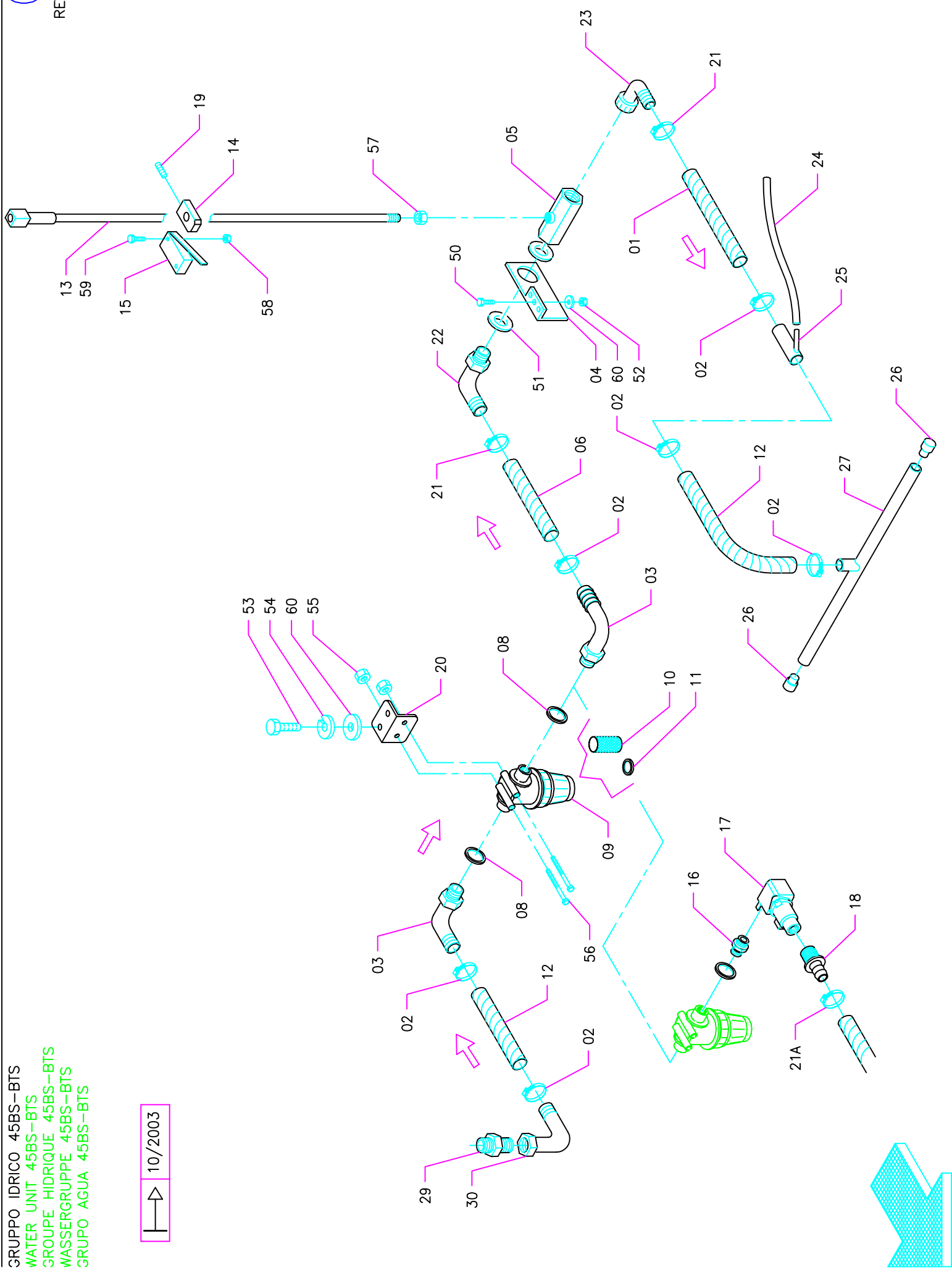

Pos.	Mod.	Codice	Q.tà	Denominazione	Denomination	Description	Benennung	Description	Benennung
1		202136	1	TUBO D.14X500 SPIRALATO	TUBE	TUYAU	ROHR	TUYAU	ROHR
2		416172	6	FASCETTA A VITE 16-22	CLAMP	COLLIER	BRIDE	COLLIER	BRIDE
3		410339	2	PORTAGOMMA A GOMITO 1/2x16 M.	CONNECTOR HOSE	RACCORD DE TUYAU	VERBINDUNG-SCHLAUCH	RACCORD DE TUYAU	UNION DE TUBO DE GOMA
4		203391	1	STAFFA RUBINETTO	SUPPORT	SUPPORT	HALTERUNG	SUPPORT	SOPORTE FIJADOR
5		203542	1	CORPO RUBINETTO	COCK	ROBINET	WASSERHAHN	ROBINET	GRIFO
6		202188	1	TUBO D.14x125 SPIRALATO	TUBE	TUYAU	ROHR	TUYAU	TUBO
7		410371	1	PORTAGOMMA DIRITTO 1/2x16	CONNECTOR	RACCORD	SCHLAUCHANSCHLUSS	RACCORD	EMPALME TUBO DE GOMA
8		408501	2	GUARNIZIONE OR 3068	GASKET	JOINT	ABDICHTUNG	JOINT	JUNTA
9		405409	1	FILTRO 1/2 F.F. 32 MESH	FILTER	FILTRE	FILTER	FILTRE	FILTRO
10		405410	1	CARTUCCIA	FILTER CARTRIDGE	CARTOUCHE DE FILTRE	FILTEREINSATZ	CARTOUCHE DE FILTRE	CARTUCHO FILTRO
11		405959	1	GUARNIZIONE	GASKET	JOINT	ABDICHTUNG	JOINT	JUNTA
12		202172	2	TUBO D.14x480 SPIRALATO	TUBE	TUYAU	ROHR	TUYAU	TUBO
13		203521	1	ASTA RUBINETTO	ROD	TIGE	STANGE	TIGE	VARILLA
14		203486	1	MORSETTO PER MICROINT.	CLAMP	BORNE	KLEMME	BORNE	BORNE
15		409498	1	MICROINTERRUTTORE	MICROSWITCH	MICROINTERRUPTEUR	MIKROSCHALTER	MICROINTERRUPTEUR	MICROINTERRUPTOR
16	*	416234	1	NIPPOLO MM 3/8-1/2 OTTONE	NIPPLE	RACCORD	NIPPEL	RACCORD	BOQUILLA ROSCADA
17	*	414646	1	ELETTRIVALVOLA COMPL.	SOLENOID VALVE	ELECTROVANNE ASSY	MAGNETVENTIL COMPLETE	ELECTROVANNE ASSY	ELECTROVALVULA COMPLETA
18	*	420741	1	PORTAGOMMA DIRITTO	CONNECTOR	RACCORD	SCHLAUCHANSCHLUSS	RACCORD	EMPALME TUBO DE GOMA
19		415808	1	GRANO M4X8	DOWEL	VIS	MADENSCHRAUBE	VIS	TORNILLO
20		203520	1	SUPPORTO FILTRO	SUPPORT	SUPPORT	HALTERUNG	SUPPORT	SOPORTE
21		410292	2	FASCETTA A VITE 11-17	CLAMP	COLLIER	BRIDE	COLLIER	ABRAZADERA
21A	*	410292	1	FASCETTA A VITE 11-17	CLAMP	COLLIER	BRIDE	COLLIER	ABRAZADERA
22		410361	1	PORTAGOMMA A GOMITO	CONNECTOR HOSE	RACCORD DE TUYAU	VERBINDUNG-SCHLAUCH	RACCORD DE TUYAU	UNION DE TUBO DE GOMA
23		416195	1	PORTAGOMMA A GOMITO	CONNECTOR HOSE	RACCORD DE TUYAU	VERBINDUNG-SCHLAUCH	RACCORD DE TUYAU	UNION DE TUBO DE GOMA
24		202211	1	TUBO D.5X1250 VITREO	TUBE	TUYAU	ROHR	TUYAU	TUBO
25		206218	1	RACCORDO SFIATO	FITTING	RACCORD	VERSCHRAUBUNG	RACCORD	RACORT
26		409832	2	CAPPUCCIO COPRIDADO	PROTECTION CAP	CALOTTE DE PROTECTION	SICHERHEITSKAPPE	CALOTTE DE PROTECTION	CAPUCHO
27		415157	1	TUBO DISTRIBUTORE	TUBE	TUYAU	ROHR	TUYAU	TUBO
28		400667	2	ROSETTA IN NYLON	WASHER	RONDELLE	SCHEIBE	RONDELLE	ARANDELA
29		410427	01	NIPLO RIDOTTO	NIPPLE	RACCORD	NIPPEL	RACCORD	BOQUILLA ROSCADA
30		416198	01	PORTA GOMMA	CONNECTOR HOSE	RACCORD DE TUYAU	VERBINDUNG-SCHLAUCH	RACCORD DE TUYAU	UNION DE TUBO DE GOMA
50		-	-	VITE M6X16 UNI 5933	SCREW	VIS	SCHRAUBE	VIS	TORNILLO
52		-	-	DADO M6 UNI 5588	NUT	ECROU	MUTTER	ECROU	TUERCA
53		-	-	VITE M6X20 UNI 5739	SCREW	VIS	SCHRAUBE	VIS	TORNILLO
54		-	-	ROSETTA M6 UNI 1751	LOCK WASHER	RONDELLE	ZAHNSCHEIBE	RONDELLE	ARANDELA DENTADA
55		-	-	DADO M8 AUTOBL. UNI 7474	LOCK NUT	ECROU AUTOBLOQUANT	STOPMUTTER	ECROU AUTOBLOQUANT	TUERCA AUTOBLOCANTE
56		-	-	VITE M8X70 UNI 5737	SCREW	VIS	SCHRAUBE	VIS	TORNILLO
57		-	-	DADO M5 UNI 5588	NUT	ECROU	MUTTER	ECROU	TUERCA
58		-	-	DADO M3 AUTOBL. UNI 7474	LOCK NUT	ECROU AUTOBLOQUANT	STOPMUTTER	ECROU AUTOBLOQUANT	TUERCA AUTOBLOCANTE
59		-	-	VITE M3X20 UNI 5739 A2	SCREW	VIS	SCHRAUBE	VIS	TORNILLO
60		-	-	ROSETTA M6 UNI 6592	WASHER	RONDELLE	SCHEIBE	RONDELLE	ARANDELA

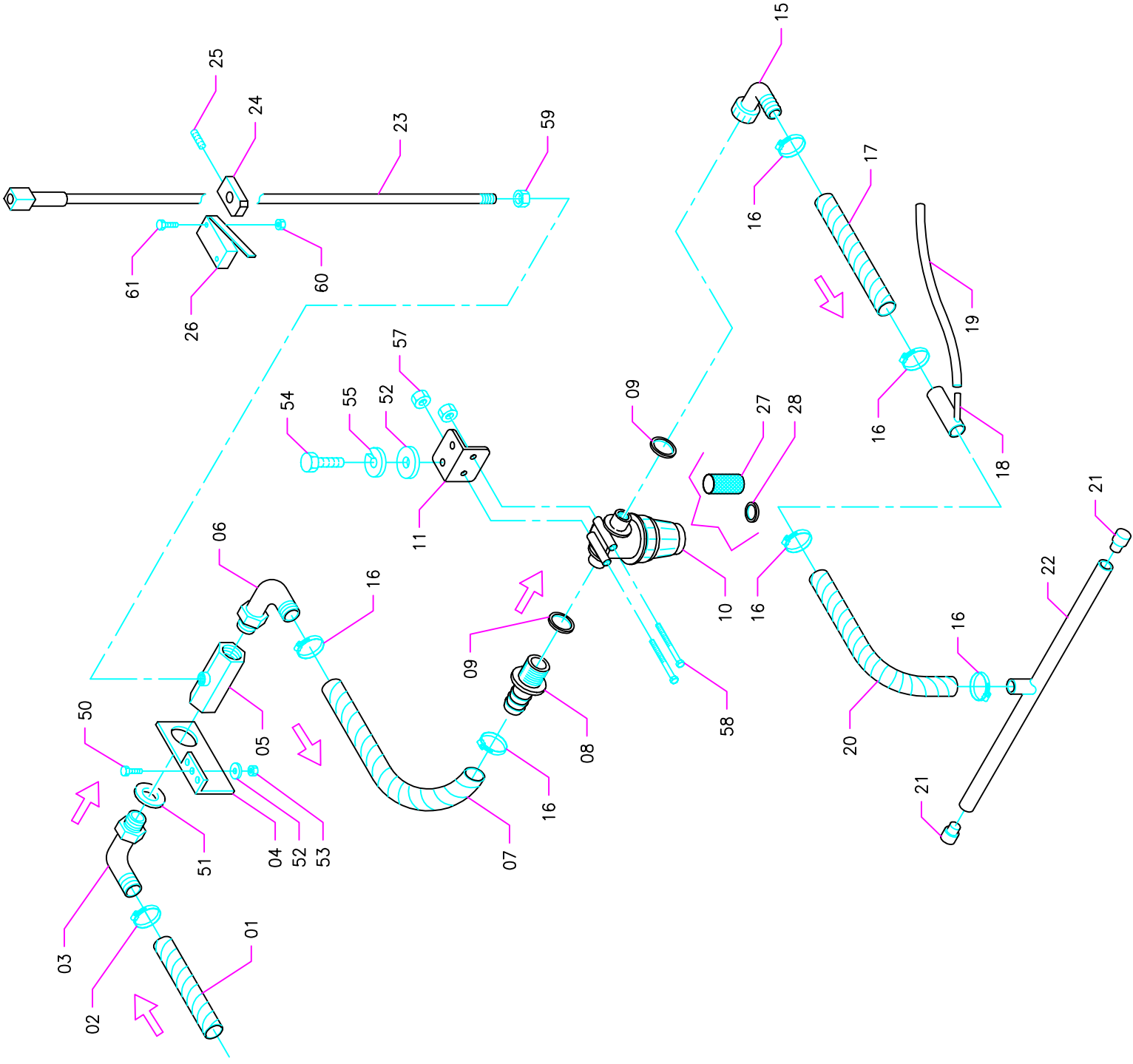

GRUPPO IDRICO 45BS-BTS
 WATER UNIT 45BS-BTS
 GROUPE HIDRIQUE 45BS-BTS
 WASSERGRUPPE 45BS-BTS
 GRUPO AGUA 45BS-BTS

↑	05/2000
↑	10/2003

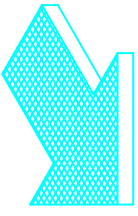

TAV.07A rev.02 GRUPPO IDRICO 45BS-BTS

Pos.	Mod.	Codice	Q.tà	Denominazione	Denomination	Description	Benennung	Description
1		202176	1	TUBO D.14X720 SPIRALATO	TUBE	TUYAU	ROHR	TUBO
2		410292	2	FASCETTA A VITE	CLAMP	COLLIER	BRIDE	ABRAZADERA
3		410361	1	PORTAGOMMA A GOMITO	CONNECTOR HOSE	RACCORD DE TUYAU SOUPLE	VERBINDUNG-SCHLAUCH	UNION DE TUBO DE GOMA
4		203391	1	STAFFA RUBINETTO	SUPPORT	SUPPORT	HALTERUNG	SOPORTE FIJADOR
5		203542	1	CORPO RUBINETTO8	COCK	ROBINET	WASSERHAHN	GRIFO
6		416195	1	PORTAGOMMA A GOMITO	CONNECTOR HOSE	RACCORD DE TUYAU SOUPLE	VERBINDUNG-SCHLAUCH	UNION DE TUBO DE GOMA
7		202152	1	TUBO D.14x250 SPIRALATO	TUBE	TUYAU	ROHR	TUBO
8		410371	1	PORTAGOMMA DIRITTO	CONNECTOR	RACCORD	SCHLAUCHANSCHLUSS	EMPALME TUBO DE GOMA
9		408501	2	GUARNIZIONE OR	GASKET	JOINT	ABDICHTUNG	JUNTA
10		405409	1	FILTRO	FILTER	FILTRE	FILTER	FILTRO
11		203520	1	SUPPORTO FILTRO	SUPPORT	SUPPORT	HALTERUNG	SOPORTE FIJADOR
15		410339	1	PORTAGOMMA A GOMITO	CONNECTOR HOSE	RACCORD DE TUYAU SOUPLE	VERBINDUNG-SCHLAUCH	UNION DE TUBO DE GOMA
16		416172	6	FASCETTA A VITE	CLAMP	COLLIER	BRIDE	ABRAZADERA
17		202150	1	TUBO D.14x320 SPIRALATO	CONNECTOR	RACCORD	SCHLAUCHANSCHLUSS	EMPALME TUBO DE GOMA
18		206218	1	RACCORDO SFIATO	FITTING	RACCORD	VERSCHRAUBUNG	RACORT
19		202211	1	TUBO D.5X1250 VITREO	TUBE	TUYAU	ROHR	TUBO
20		202172	1	TUBO D.14X480 SPIRALATO	TUBE	TUYAU	ROHR	TUBO
21		409832	2	CAPPUCCIO COPRIDADO	PROTECTION CAP	CALOTTE DE PROTECTION	SICHERHEITSKAPPE	CAPUCHO
22		415157	1	TUBO DISTRIBUTORE	TUBE	TUYAU	ROHR	TUBO
23		203521	1	ASTA RUBINETTO	ROD	TIGE	STANGE	VARILLA
24		203486	1	MORSETTO	CLAMP	BORNE	KLEMME	BORNE
25		415808	1	GRANO M4X8	DOWEL	VIS	MADENSCHRAUBE	TORNILLO
26		409498	1	MICROINTERRUTTORE	MICROSWITCH	MICROINTERRUPTEUR	MIKROSCHALTER	MICROINTERRUPTOR
27		405410	1	CARTUCCIA FILTRO	FILTER CARTRIDGE	CARTOUCHE DE FILTRE	FILTEREINSATZ	CARTUCHO FILTRO
28		405959	1	GUARNIZIONE PIANA	GASKET	JOINT	ABDICHTUNG	JUNTA
50		-	-	VITE M6X16 UNI 5933	SCREW	VIS	SCHRAUBE	TORNILLO
51		-	-	ROSETTA M20 UNI 6592	WASHER	RONDELLE	SCHEIBE	ARANDELA
52		-	-	ROSETTA M6 UNI 6592	WASHER	RONDELLE	SCHEIBE	ARANDELA
53		-	-	DADO M6 AUTOBL. UNI 7474	LOCK NUT	ECROU AUTOBLOQUANT	STOPMUTTER	TUERCA AUTOBLOCANTE
54		-	-	VITE M6X20 UNI 5739	SCREW	VIS	SCHRAUBE	TORNILLO
55		-	-	ROSETTA M6 UNI 1751	LOCK WASHER	RONDELLE	ZAHNSCHEIBE	ARANDELA DENTADA
57		-	-	DADO M8 AUTOBL. UNI 7474	LOCK NUT	ECROU AUTOBLOQUANT	STOPMUTTER	TUERCA AUTOBLOCANTE
58		-	-	VITE M8X70 UNI 5737	SCREW	VIS	SCHRAUBE	TORNILLO
59		-	-	DADO M5 UNI 5588	NUT	ECROU	MUTTER	TUERCA
60		-	-	DADO M3 AUTOBL. UNI 7474	LOCK NUT	ECROU AUTOBLOQUANT	STOPMUTTER	TUERCA AUTOBLOCANTE
61		-	-	VITE M3X20 UNI 5739 A2	SCREW	VIS	SCHRAUBE	TORNILLO

GRUPPO COMANDO SPAZZOLE B-BT / BS-BTS
 BRUSHES CONTROL ASSEMBLY B-BT / BS-BTS
 GROUPE COMMANDE DES BROSSES B-BT / BS-BTS
 GRUPPE BÜRSTENBETÄTIGUNG B-BT / BS-BTS
 GRUPO MANDO CEPILLOS B-BT / BS-BTS

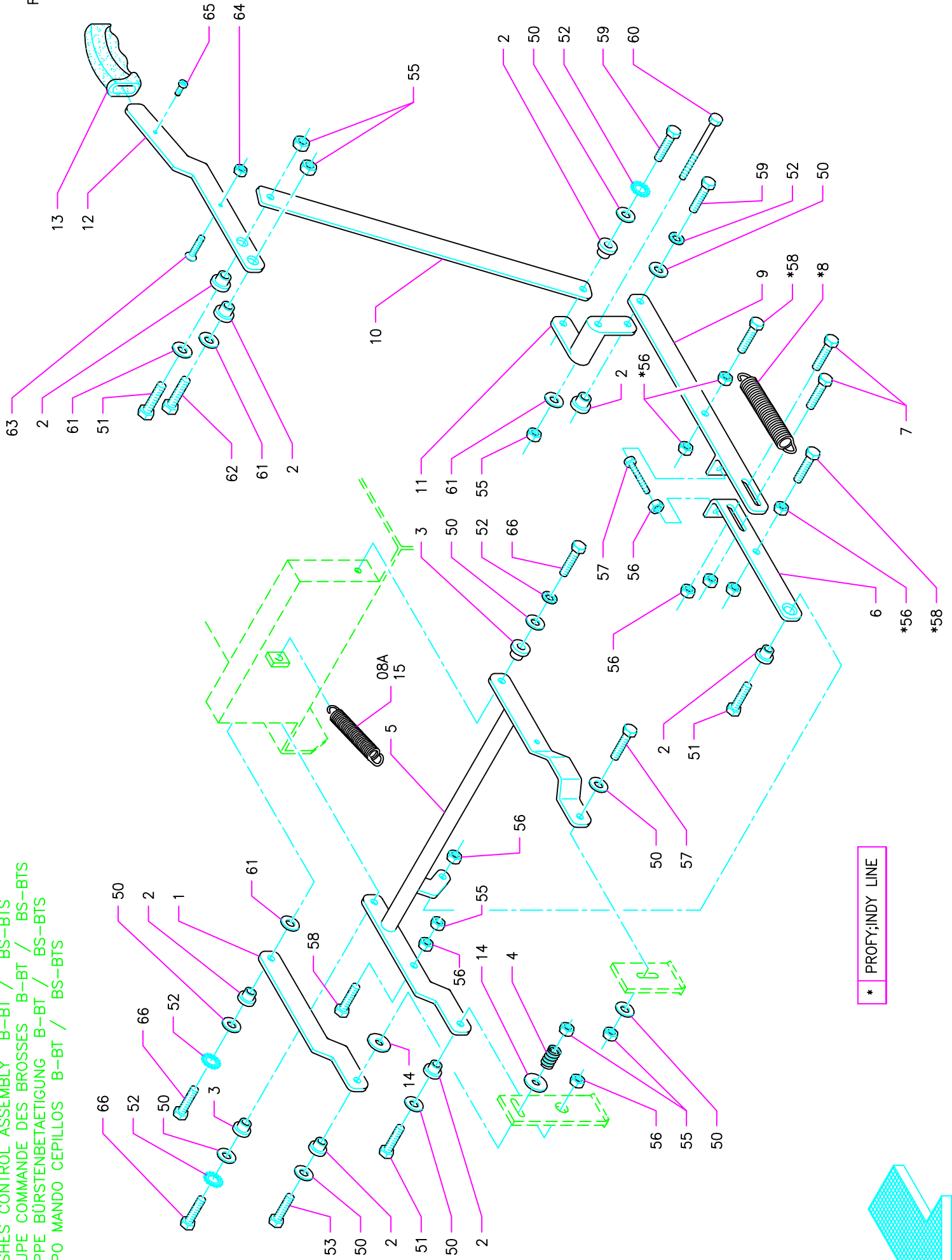

* PROFY:INDY LINE

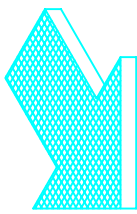

TAV.08 rev.01 GRUPPO COMANDO SPAZZOLE B-BT / BS-BTS

Po	Mod.	Codice	Q.tà	Denominazione	Denomination	Description	Benennung	Description
1		203491	1	BRACCIO	ARM	BRAS	ARM	BRAZO
2		408018	9	BOCCOLA	BUSHING	DOUILLE	BUCHSE	CASQUILLO
3		408020	2	BOCCOLA	BUSHING	DOUILLE	BUCHSE	CASQUILLO
4	452/502	408094	1	MOLLA	SPRING	RESSORT	FEDER	RESORTE
5		412449	1	BRACCIO	ARM	BRAS	ARM	BRAZO
6		203496	1	LAMA ANTERIORE	KNIFE	LAME	KLINGE	HOJA
7		203495	2	COLONETTA	STUD BOLT	TIGE	GEWINDEBOLZEN	PRISIONERO
8		202482	1	MOLLA	SPRING	RESSORT	FEDER	RESORTE
8A	BS-BTS	202482	1	MOLLA	SPRING	RESSORT	FEDER	RESORTE
9		203494	1	LAMA	KNIFE	LAME	KLINGE	HOJA
10		203493	1	TIRANTE	TIE ROD	TIRANT	STANGE	VARILLA
11		412450	1	RINVIO	RETURN	RENVOI	VERWEISEN	APLAZAMIENTO
12		203492	1	MANETTA	HANDLE	MENOTTES	HANDSCHELLE	MANETA
13		410253	1	MANOPOLA	HANDLE	POGNEE	GRIFF	MANGO
14	452/502	409182	2	RONDELLA Ø 8X30X3NYLON	WASHER	RONDELLE	SCHEIBE	ARANDELA
15	B-BT	202476	1	MOLLA	SPRING	RESSORT	FEDER	RESORTE
50		-	-	RONDELLA M8 D.24 UNI 6593	WASHER	RONDELLE	SCHEIBE	ARANDELA
51		-	-	VITE M8X25 UNI 5739	SCREW	ECROU	MUTTER	TUERCA
52		-	-	RONDELLA M8 DIN 6798/A	WASHER	RONDELLE	SCHEIBE	ARANDELA
53		-	-	VITE M8X40 UNI 5739	SCREW	ECROU	MUTTER	TUERCA
55		--	-	DADO M8 AUTOBL. UNI 7474	NUT	ECROU	MUTTER	TUERCA
56		-	-	DADO M8 UNI 5588	NUT	ECROU	MUTTER	TUERCA
57		-	-	VITE M8X30 UNI 5739	SCREW	VIS	SCHRAUBE	TORNILLO
58		-	-	VITE M8X45 UNI 5739	SCREW	VIS	SCHRAUBE	TORNILLO
59		-	-	VITE M8X20 UNI 5739	SCREW	VIS	SCHRAUBE	TORNILLO
60		-	-	VITE M8X90 UNI 5737	SCREW	VIS	SCHRAUBE	TORNILLO
61		-	-	RONDELLA M8 UNI 6592	WASHER	RONDELLE	SCHEIBE	ARANDELA
62		-	-	VITE M8X25 UNI 5933	SCREW	VIS	SCHRAUBE	TORNILLO
63		-	-	VITE M6X20 UNI 5933	SCREW	VIS	SCHRAUBE	TORNILLO
64		-	-	DADO M6 UNI 5588	NUT	ECROU	MUTER	TUERCA
65		-	-	VITE Ø 4,8X13 AUTOFIL. UNI 6954	SCREW	VIS	SCHRAUBE	TORNILLO
66		-	-	VITE M8X35 UNI 5739	SCREW	VIS	SCHRAUBE	TORNILLO

GRUPPO SERBATOI B-BT / BS-BTS
 TANK ASSEMBLY B-BT / BS-BTS
 GROUPE DE RESERVOIRS B-BT / BS-BTS
 TANKGRUPPE B-BT / BS-BTS
 GRUPO TANQUES B-BT / BS-BTS

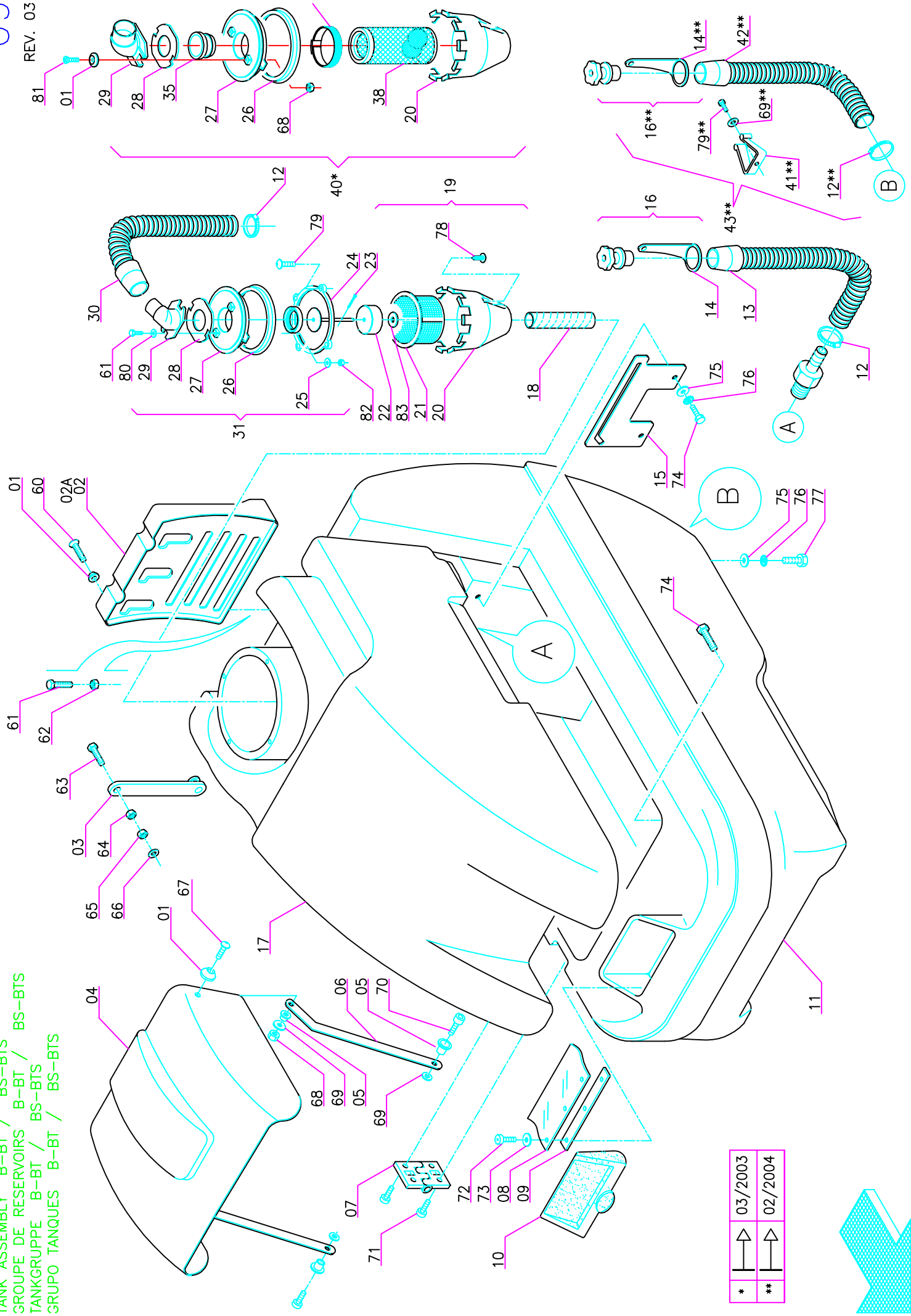

*	↑	03/2003
**	↑	02/2004

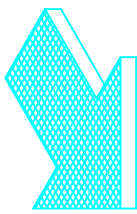

TAV.09 rev.03 GRUPPO SERBATOIO B-BT / BS-BTS

Po	Mod.	Codice	Q.tà	Denominazione	Denomination	Description	Benennung	Description
1		400250	6	RONDELLA SOTTOVITE	WASHER	RONDELLE	SCHEIBE	ARANDELA
2	B-BS	415147	1	CARTER POSTERIORE	COVER	CARTER	ABDECKUNG	TAPA
2A	BT-BTS	415148	1	CARTER POSTERIORE	COVER	CARTER	ABDECKUNG	TAPA
3		415144	1	PUNTELLO SERBATOIO	PANEL	PANNEAU	PLATTE	PANEL
4		415146	1	COFANO SERB. RECUPERO	BONNET	CAPOT	ABDECKHAUBE	CAPOTA
5		411762	4	BOCCOLA	BUSHING	BAGUE	BUCHSE	CASQUILLO
6		203515	2	STAFFA COFANO	BRACKET	BRIDE	HALTER	SOPORTE
7		412002	2	CERNIERA COFANO	HINGE	CHARNIERE	SCHARNIER	BISAGRA
8		415095	1	PARAFILTI SERBATOIO	SPLASH GUARD	BAVETTE	SPRITZGUMMI	PARASALPICADURAS
9		415096	1	LISTELLO	BLADE	LAME	LEISTE	LISTON
10		415094	1	COPERCHIO SERBATOIO	COVER	COUVERCLE	DECKEL	TAPA
11		414817	1	SERBATOIO SOLUZIONE	TANKS	RESERVOIRS	TANKS	TANQUES
12		420512	2	FASCETTA A VITE	CLAMP	COLLIER	BRIDE	ABRAZADERA
13		202168	1	TUBO SPIRALATO	PIPE	TUBE	ROHR	TUBO
14		420678	1	FASCETTA	CLAMP	COLLIER	BRIDE	ABRAZADERA
15		203517	1	STAFFA FISSA PER PUNTELLO	BRACKET	BRIDE	HALTER	SOPORTE
16		203127	1	KIT TAPPO SCARICO COMPLETO	OUTLET PLUG COMPLETE	KIT BOUCHON DE DECHAR.	STOPFEN	TAPON
17		414818	1	SERBATOIO RECUPERO	TANKS	RESERVOIRS	TANKS	TANQUES
18		202133	1	TUBO SPIRALATO	PIPE	TUBE	ROHR	TUBO
19		203163	1	PROTEZIONE + FILTRO ASP.	ASSEMBLY PROTEC./FILTER	GROUPE DE PROTEC. + FILTRE	GRUPE SCHUTZ + FILTER	GRUPO PROTECCION+FILTRO
20		400727	1	PROTEZIONE GALLEGGIANTE	PROTECTION	PROTECTION	ABDECKUNG	PROTECCION
21		405378	1	FILTRO	FILTER	FILTRE	FILTER	FILTRO
22		400540	1	GALLEGGIANTE	FLOAT	FLOTTEUR	SCHWIMMER	FLOTADOR
23		409383	1	COPIGLIA	SPLIT PIN	GOUPILLE	SPLINT	PASADOR DE ALETAS
24		400726	1	SEDE PER PORTAFILTRO	FILTER HOLDER	PORTE-FILTRE	FILTERTRÄGER	PORTAFILTRO
25		409148	4	ROSETTA NYLON	WASHER	RONDELLE	SCHEIBE	ARANDELA
26		405466	1	GUARNIZIONE FILTRO SERBATOIO	GASKET	JOINT	ABDICHTUNG	JUNTA
27		400541	1	TAPPO PER SERBATOIO	PLUG	BOUCHON	DECKEL	PORTEZUELA
28		405908	1	GUARNIZIONE ATTACCO TUBO	GASKET	JOINT	ABDICHTUNG	JUNTA
29		400127	1	ATTACCO PER BOCCHETTA	COUPLING	ATTAQUE	KUPPLUNG	SOPORTE
30		202167	1	TUBO SPIRALATO	PIPE	TUBE	ROHR	TUBO
31		203164	1	KIT TAPPO ASPIRAZIONE	ASSEMBLY SUCTION PLUG	GROUPE BOUCHON D'ASPIR.	GRUPE ABSAUGDECKEL	GRUPO TAPON DE ASPIRACION
32		411988	1	FASCETTA A SCATTO	CLAMP	COLLIER	BRIDE	ABRAZADERA
35		411822	1	RACCORDO ATTACCO FILTRO	FITTING	RACCORD	VERSCHRAUBUNG	RACORT
38		411674	1	FILTRO ASPIRAZIONE AIR STOP	FILTER	FILTRE	FILTER	FILTRO
40		200339	1	TAPPO ASPIRAZIONE COMPLETO	PLUG	BOUCHON	DECKEL	PORTEZUELA
41		412123	1	AGGANCIO	COUPLER	ACCROCHAGE	HALTERUNG	ENGANCHE
42		202191	1	TUBO SPIRALATO TRASPARENTE	PIPE	TUBE	ROHR	TUBO
43		202887	-	KIT TUBO SCARICO/LIVELLO ACQUA	EXHAUST PIPE ASSEMBLY/WATER LEVEL	KIT FLEXIBLE VIDANGE/NIVEAU EAU	KIT ABLAßSCHLAUCH/WASSERSTAND	KIT TUBO DESAGÜE/NIVEL AGUA
60		-	-	VITE M5X16 UNI 7688	SCREW	VIS	SCHRAUBE	TORNILLO
61		-	-	VITE M4X25 UNI 5739 A2	SCREW	VIS	SCHRAUBE	TORNILLO

GRUPPO SERBATOI B-BT / BS-BTS
 TANK ASSEMBLY B-BT / BS-BTS
 GROUPE DE RESERVOIRS B-BT / BS-BTS
 TANKGRUPPE B-BT / BS-BTS
 GRUPO TANQUES B-BT / BS-BTS

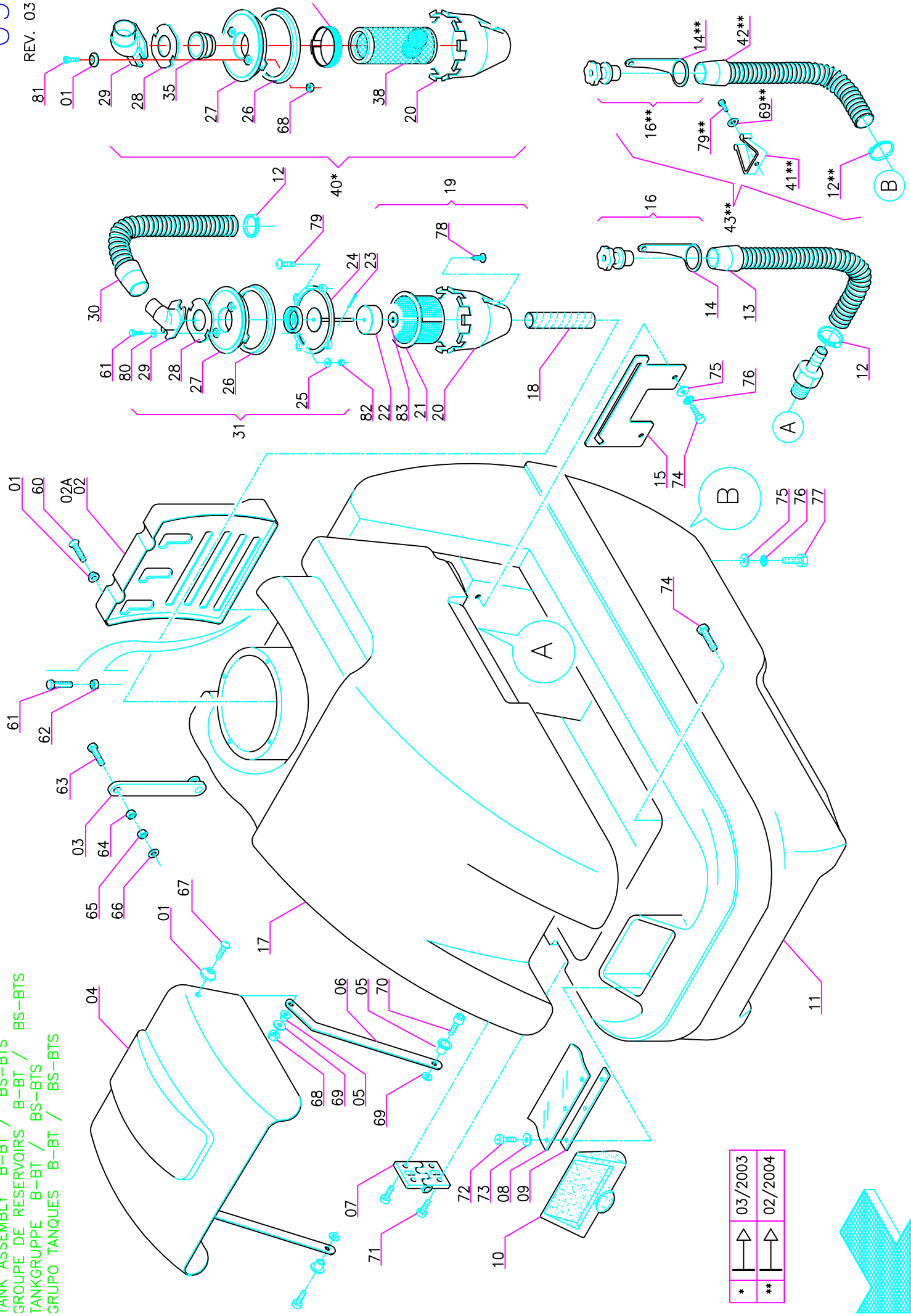

*	↑	03/2003
**	↑	02/2004

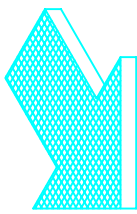

TAV.09 rev.03 GRUPPO SERBATOI B-BT / BS-BTS

Po	Mod.	Codice	Q.tà	Denominazione	Denomination	Description	Benennung	Description
62	-	-	-	DADO M4 AUTOBL. UNI 7474	LOCK NUT	ECROU AUTOBLOQUANT	STOPMUTTER	TUERCA AUTOBLOCANTE
63	-	-	-	VITE M8X45 UNI 5739	SCREW	VIS	SCHRAUBE	TORNILLO
64	-	-	-	DADO M8 AUTOBL. UNI 7474	LOCK NUT	ECROU AUTOBLOQUANT	STOPMUTTER	TUERCA AUTOBLOCANTE
65	-	-	-	DADO M8 UNI 5588	NUT	ECROU	MUTTER	TUERCA
66	-	-	-	ROSETTA M8 UNI 6592	WASHER	RONDELLE	SCHEIBE	ARANDELA
67	-	-	-	VITE M5X20 UNI 7687	SCREW	VIS	SCHRAUBE	TORNILLO
68	-	-	-	DADO M5 AUTOBL. UNI 7474	LOCK NUT	ECROU AUTOBLOQUANT	STOPMUTTER	TUERCA AUTOBLOCANTE
69	-	-	-	ROSETTA M5 D.15 UNI 6593	WASHER	RONDELLE	SCHEIBE	ARANDELA
70	-	-	-	VITE M5X16 UNI 7380	SCREW	VIS	SCHRAUBE	TORNILLO
71	-	-	-	VITE M6X14 UNI 5931	SCREW	VIS	SCHRAUBE	TORNILLO
72	-	-	-	VITE M5X20 UNI 7687 A2	SCREW	VIS	SCHRAUBE	TORNILLO
73	-	-	-	ROSETTA M5 UNI 6592 A2	WASHER	RONDELLE	SCHEIBE	ARANDELA
74	-	-	-	VITE M6X16 UNI 5739	SCREW	VIS	SCHRAUBE	TORNILLO
75	-	-	-	ROSETTA M6 D.18 UNI 6593	WASHER	RONDELLE	SCHEIBE	ARANDELA
76	-	-	-	ROSETTA DIN 6798/A	LOCK WASHER	RONDELLE	ZAHNSCHEIBE	ARANDELA DENTADA
77	-	-	-	VITE M6X35 UNI 5933	SCREW	VIS	SCHRAUBE	TORNILLO
78	-	-	-	VITE Ø 3.9X13 AUTOFIL. UNI 6954	SCREW	VIS	SCHRAUBE	TORNILLO
79	-	-	-	VITE Ø 4.2X16 AUTOFIL. UNI 6954	SCREW	VIS	SCHRAUBE	TORNILLO
80	-	-	-	ROSETTA M5 D.20 UNI 6593	WASHER	RONDELLE	SCHEIBE	ARANDELA
81	-	-	-	VITE M5X25 UNI 7688	SCREW	VIS	SCHRAUBE	TORNILLO
82	-	-	-	DADO M4 UNI5588 INOX	NUT	ECROU	MUTTER	TUERCA
83	-	-	-	ROSETTA M6 D.24 UNI6593 INOX	WASHER	RONDELLE	SCHEIBE	ARANDELA

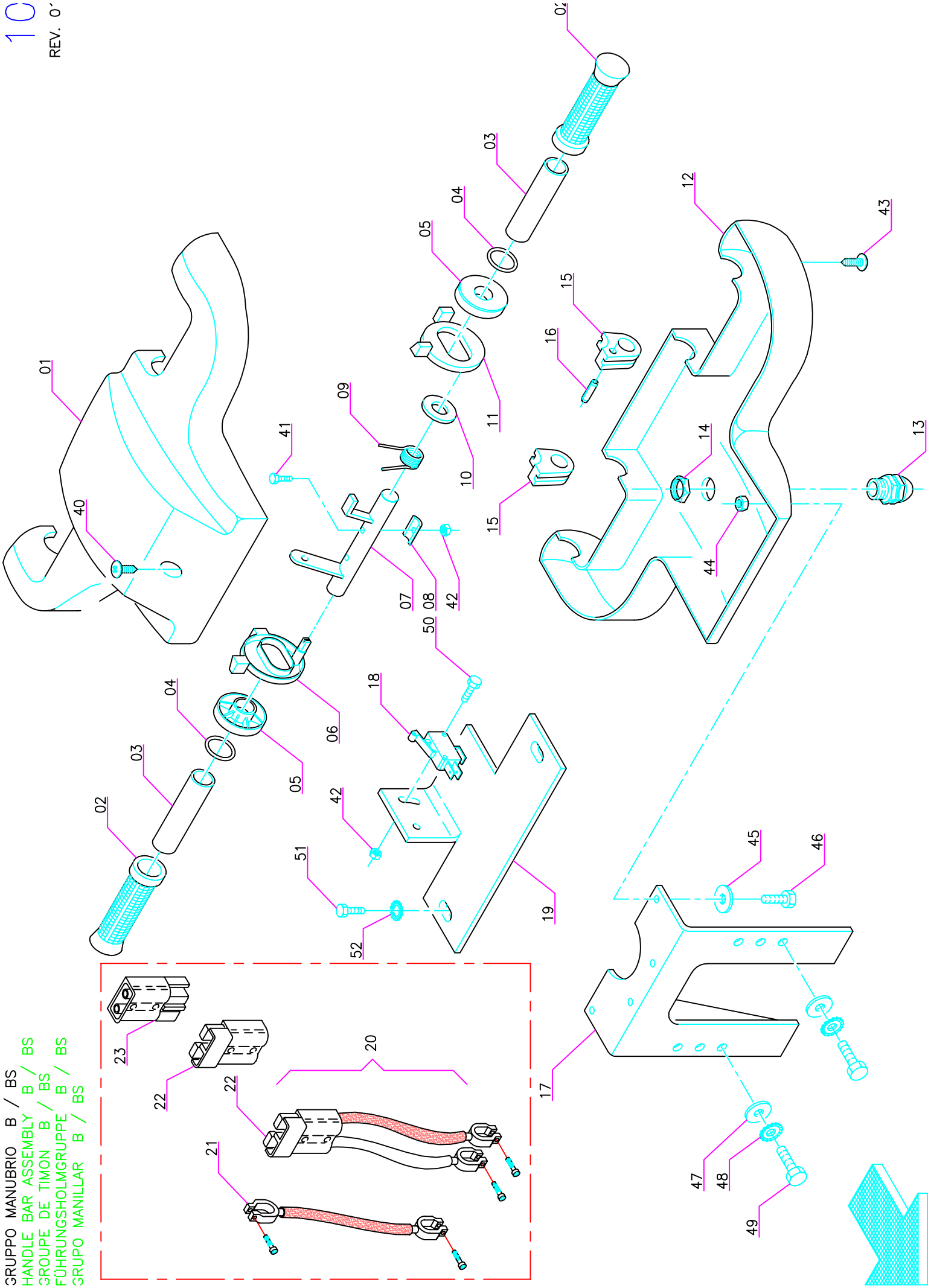

GRUPPO MANUBRIO B / BS
 HANDLE BAR ASSEMBLY B / BS
 GROUPE DE TIMON B / BS
 FÜHRUNGSHOLMGRUPPE B / BS
 GRUPO MANILLAR B / BS

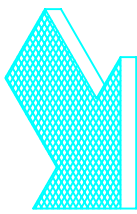

TAV.10 rev.01 GRUPPO MANUBRIO B / BS

Pos.	Mod.	Codice	Q.tà	Denominazione	Denomination	Description	Benennung	Description
1		203511	1	COPERCHIO MANUBRIO	COVER	COUVERCLE	DECKEL	TAPA
2		410250	2	MANOPOLA IN GOMMA FORO D.25	KNOB	POIGNEE	HANDGRIFF	EMPUÑADURA
3		415140	2	TUBO MANUBRIO	PIPE	TUBE	ROHR	TUBO
4		415686	2	GUARNIZIONE OR	O-RING	JOINT	O-RING	JUNTA ANULAR
5		400664	2	RONDELLA MANUBRIO	WASHER	RONDELLE	SCHEIBE	ARANDELA
6		400646	1	LEVA	LEVER	LEVIER	HABEL	PALANCA
7		415141	1	ALBERO	SHAFT	ARBRE	LENKWELLE	EJE
8		400648	2	PIASTRINA DI COMPENSO	SUPPORT PLATE	PLAQUETTE	STÜTZPLATTE	OREJA DE APOYO
9		408131	1	MOLLA COMANDO MARCIA G42	SPRING	RESSORT	FEDER	RESORTE
10		203513	1	RONDELLA MANUBRIO	WASHER	RONDELLE	SCHEIBE	ARANDELA
11		400647	1	LEVA	LEVER	LEVIER	HABEL	PALANCA
12		203510	1	CORPO MANUBRIO	HANDLE BAR BODY	CORPS DE TIMON	FÜHRUNGSHOLMKÖRPER	CUERPO MANILLAR
13		409752	1	PRESSACAVO	FAIR-LEAD	PRESSE-ETOUIPE	KABELFÜHRUNG	BRIDA CABLE
14		409754	1	DADO 1/2 GRIGIO x PRESSACAVO	NUT	ECROU	MUTTER	TUERCA
15		415142	2	PIASTRINA	SUPPORT PLATE	PLAQUETTE	STÜTZPLATTE	OREJA DE APOYO
16		409368	1	SPINA ELASTICA 4X28	ELASTIC PIN	CHEVILLE ELASTIQUE	SPANNSTIFT	ESPIÑA ELASTICA
17		203508	1	STAFFA MANUBRIO	BRACKET	ATTACHE	BÜGEL	SOPORTE FIJADOR
18		411973	1	MICROINTERRUTTORE	MICROINTERRUTTORE	MICROSWITCH	MICROINTERRUPTEUR	MIKROSCHALTER
19		203514	1	STAFFA INTERNA MANUBRIO	BRACKET	ATTACHE	BÜGEL	SOPORTE FIJADOR
20		414545	1	CAVO BATTERIA	CABLE	CABLE	KABEL	CUERDA
21		406398	1	CAVO PONTE BATTERIE	CABLE	CABLE	KABEL	CUERDA
22		204355	1	CONNETTORE FEMMINA	CONNECTOR FEMALE	CONNECTEUR FEMELLE	STECKER OHNE ZAPFEN	CONNECTADOR
23		204354	1	CONNETTORE MASCHIO	CONNECTOR MALE	CONNECTEUR MALE	LADESTECKER MIT ZAPFEN	CONNECTADOR
40		-	-	VITE Ø 4.8X32 AUTOFIL. UNI 6954	SCREW	VIS	SCHRAUBE	TORNILLO
41		-	-	VITE M3X20 UNI 5739 A2	SCREW	VIS	SCHRAUBE	TORNILLO
42		-	-	DADO M3 AUTOBL. UNI 7474	LOCK NUT	ECROU AUTOBLOQUANT	STOPMUTTER	TUERCA AUTOBLOCANTE
43		-	-	VITE Ø 4.8X25 AUTOFIL. UNI 6954	SCREW	VIS	SCHRAUBE	TORNILLO
44		-	-	DADO M6 AUTOBL. UNI 7474	LOCK NUT	ECROU AUTOBLOQUANT	STOPMUTTER	TUERCA AUTOBLOCANTE
45		-	-	ROSETTA M6 UNI 6592	WASHER	RONDELLE	SCHEIBE	ARANDELA
46		-	-	VITE M6X20 UNI 5739	SCREW	VIS	SCHRAUBE	TORNILLO
47		-	-	ROSETTA M8 UNI 6592	WASHER	RONDELLE	SCHEIBE	ARANDELA
48		-	-	ROSETTA M8 DIN 6798/A	LOCK WASHER	RONDELLE	ZAHNSCHEIBE	ARANDELA DENTADA
49		-	-	VITE M8X20 UNI 5739	SCREW	VIS	SCHRAUBE	TORNILLO
50		-	-	VITE M3X20 UNI 5739	SCREW	VIS	SCHRAUBE	TORNILLO
51		-	-	VITE Ø 4.8X13 AUTOFIL. UNI 6954	SCREW	VIS	SCHRAUBE	TORNILLO
52		-	-	ROSETTA M5 DIN 6798/A	LOCK WASHER	RONDELLE	ZAHNSCHEIBE	ARANDELA DENTADA

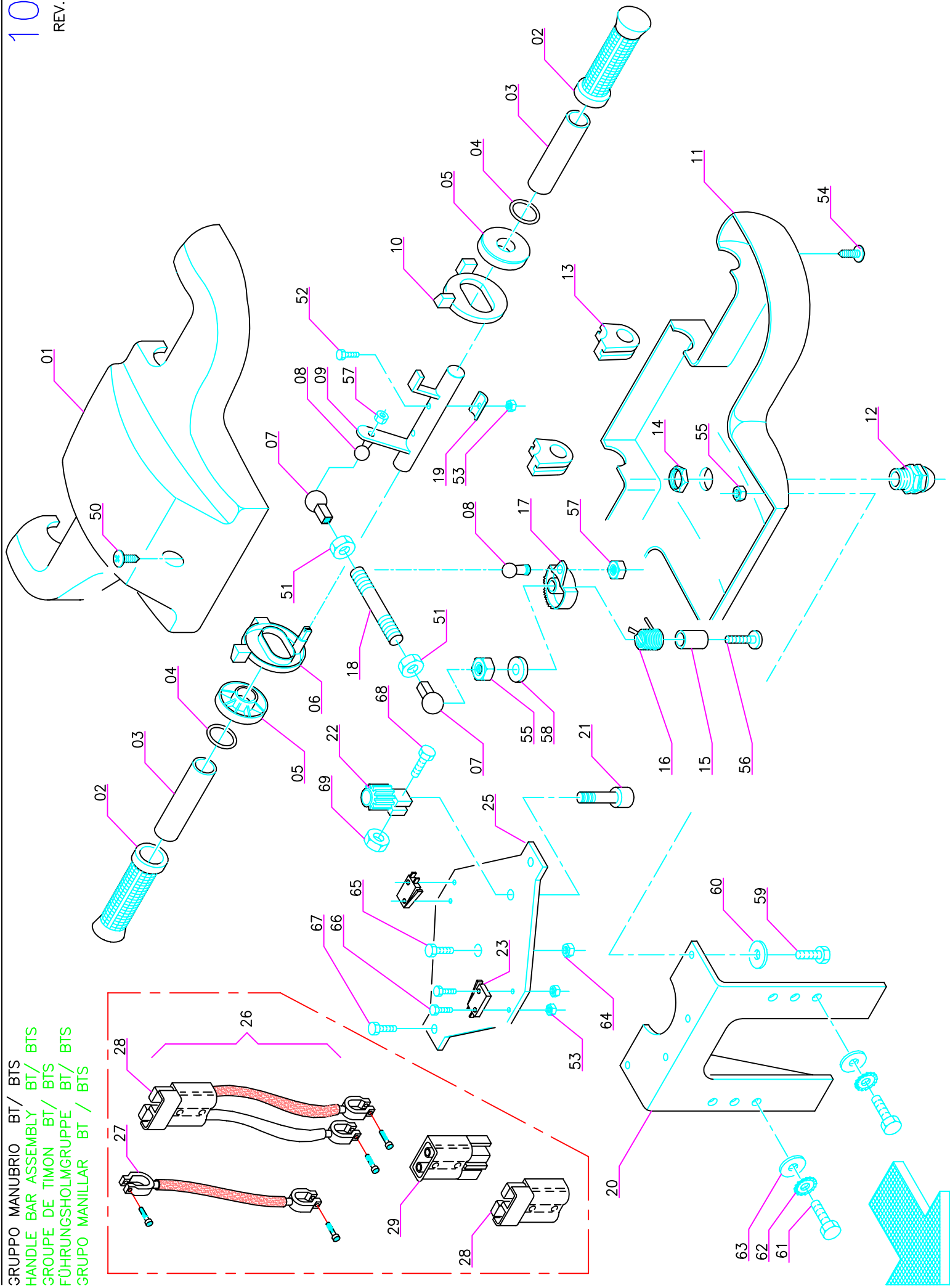

- GRUPPO MANUBRIO BT/ BTS
- HANDLE BAR ASSEMBLY BT/ BTS
- GROUPE DE TIMON BT/ BTS
- FÜHRUNGSHOLMGRUPPE BT/ BTS
- GRUPO MANILLAR BT / BTS

TAV.10A rev.0A GRUPPO MANUBRIO BT / BTS

Pos.	Mod.	Codice	Q.tà	Denominazione	Denomination	Description	Benennung	Description
1		203511	1	COPERCHIO MANUBRIO	COVER	COVERCLE	DECKEL	TAPA
2		410250	2	MANOPOLA IN GOMMA	KNOB	POIGNEE	HANDGRIFF	EMPUÑADURA
3		415140	2	TUBO MANUBRIO	PIPE	TUBE	ROHR	TUBO
4		415686	2	GUARNIZIONE OR	O-RING	JOINT	O-RING	JUNTA ANULAR
5		400664	2	RONDELLA MANUBRIO	WASHER	RONDELLE	SCHEIBE	ARANDELA
6		400646	1	LEVA	LEVER	LEVIER	HABEL	PALANCA
7		410316	2	TESTINA REGISTRABILE	ADJUSTABLE HEAD	TETE REGLABLE	JUSTIERSCHRAUBE	CABEZA AJUSTABLE
8		203279	2	PERNETTO	PIN COUPLER	AXE A FIXATION	SCHNAPPVERSCHLUSS	PASADOR
9		415141	1	ALBERO	SHAFT	ARBRE	LENKWELLE	EJE
10		400647	1	LEVA	LEVER	LEVIER	HABEL	PALANCA
11		203510	1	CORPO MANUBRIO	HANDLE BAR BODY	CORPS DE TIMON	FÜHRUNGSHOLMKÖRPER	CUERPO MANILLAR
12		409752	1	PRESSACAVO	FAIR-LEAD	PRESSE-ETOUBE	KABELFÜHRUNG	BRIDA CABLE
13		415142	2	PIASTRINA	SUPPORT PLATE	PLAQUETTE	STÜTZPLATTE	OREJA DE APOYO
14		409754	1	DADO 1/2 GRIGIO x PRESSACAVO	NUT	EGROU	MUTTER	TUERCA
15		210183	1	BOCCOLA PER CAMMA PEDALE	BUSHING	DOUILLE	BUCHSE	CASQUILLO
16		407596	1	MOLLA POTENZIOMETRO	SPRING	RESSORT	FEDER	RESORTE
17		400678	1	CORONA PER COMANDO MARCIA	CROWN GEAR	COURONNE	ZAHNKETTENRAD	CORONA DENTADA
18		415810	1	GRANO M5X45	TIE ROD	TIGE	SPANNSTANGE	TIRANTE
19		400648	2	PIASTRINA DI COMPENSO	SUPPORT PLATE	PLAQUETTE	STÜTZPLATTE	OREJA DE APOYO
20		203508	1	STAFFA MANUBRIO	BRACKET	ATTAQUE	BÜGEL	SOPORTE FIADOR
21		409248	1	POTENZIOMETRO	POTENTIOMETER	POTENTIOMETRE	POTENTIOMETER	POTENCIOMETRO
22		400679	1	PIGNONE PER COMANDO MARCIA	PINION	PIGNON	RITZEL	PIÑON
23		411973	2	MICROINTERRUTTORE	MICROINTERRUTTORE	MICROSWITCH	MICROINTERRUPTEUR	MIKROSCHALTER
25		203507	1	STAFFA INTERNA	BRACKET	ATTAQUE	BÜGEL	SOPORTE FIADOR
26		414545	1	CAVO BATTERIA	CABLE	CABLE	KABEL	CUERDA
27		406398	1	CAVO PONTE BATTERIE	CABLE	CABLE	KABEL	CUERDA
28		204355	1	CONNETTORE FEMMINA	CONNECTOR FEMALE	CONNECTEUR FEMELLE	STECKER OHNE ZAPFEN	CONNECTADOR
29		204354	1	CONNETTORE MASCHIO	CONNECTOR MALE	CONNECTEUR MALE	LADESTCKER MIT ZAPFEN	CONNECTADOR
50		-	-	VITE Ø 4,8X32 AUTOFIL. UNI 6954	SCREW	VIS	SCHRAUBE	TORNILLO
51		-	-	DADO M5 UNI 5588	NUT	ECROU	MUTTER	TUERCA
52		-	-	VITE M3X20 UNI 5739 A2	SCREW	VIS	SCHRAUBE	TORNILLO
53		-	-	DADO M3 AUTOBL. UNI 7474	LOCK NUT	ECROU AUTOBLOQUANT	STOPMUTTER	TUERCA AUTOBLOCANTE
54		-	-	VITE Ø 4,8X25 AUTOFIL. UNI 6954	SCREW	VIS	SCHRAUBE	TORNILLO
55		-	-	DADO M6 AUTOBL. UNI 7474	LOCK NUT	ECROU AUTOBLOQUANT	STOPMUTTER	TUERCA AUTOBLOCANTE
56		-	-	VITE M6X45 UNI 5739	SCREW	VIS	SCHRAUBE	TORNILLO
57		-	-	DADO M5 AUTOBL. UNI 7474	LOCK NUT	ECROU AUTOBLOQUANT	STOPMUTTER	TUERCA AUTOBLOCANTE
58		-	-	ROSETTA M6 D.18 UNI 6593	WASHER	RONDELLE	SCHEIBE	ARANDELA
59		-	-	VITE M6X20 UNI 5739	SCREW	VIS	SCHRAUBE	TORNILLO
60		-	-	ROSETTA M6 UNI 6592	WASHER	RONDELLE	SCHEIBE	ARANDELA
61		-	-	VITE M8X20 UNI 5739	SCREW	VIS	SCHRAUBE	TORNILLO
62		-	-	ROSETTA M8 DIN 6798/A	LOCK WASHER	RONDELLE	ZAHNSCHEIBE	ARANDELA DENTADA
63		-	-	ROSETTA M8 UNI 6592	WASHER	RONDELLE	SCHEIBE	ARANDELA

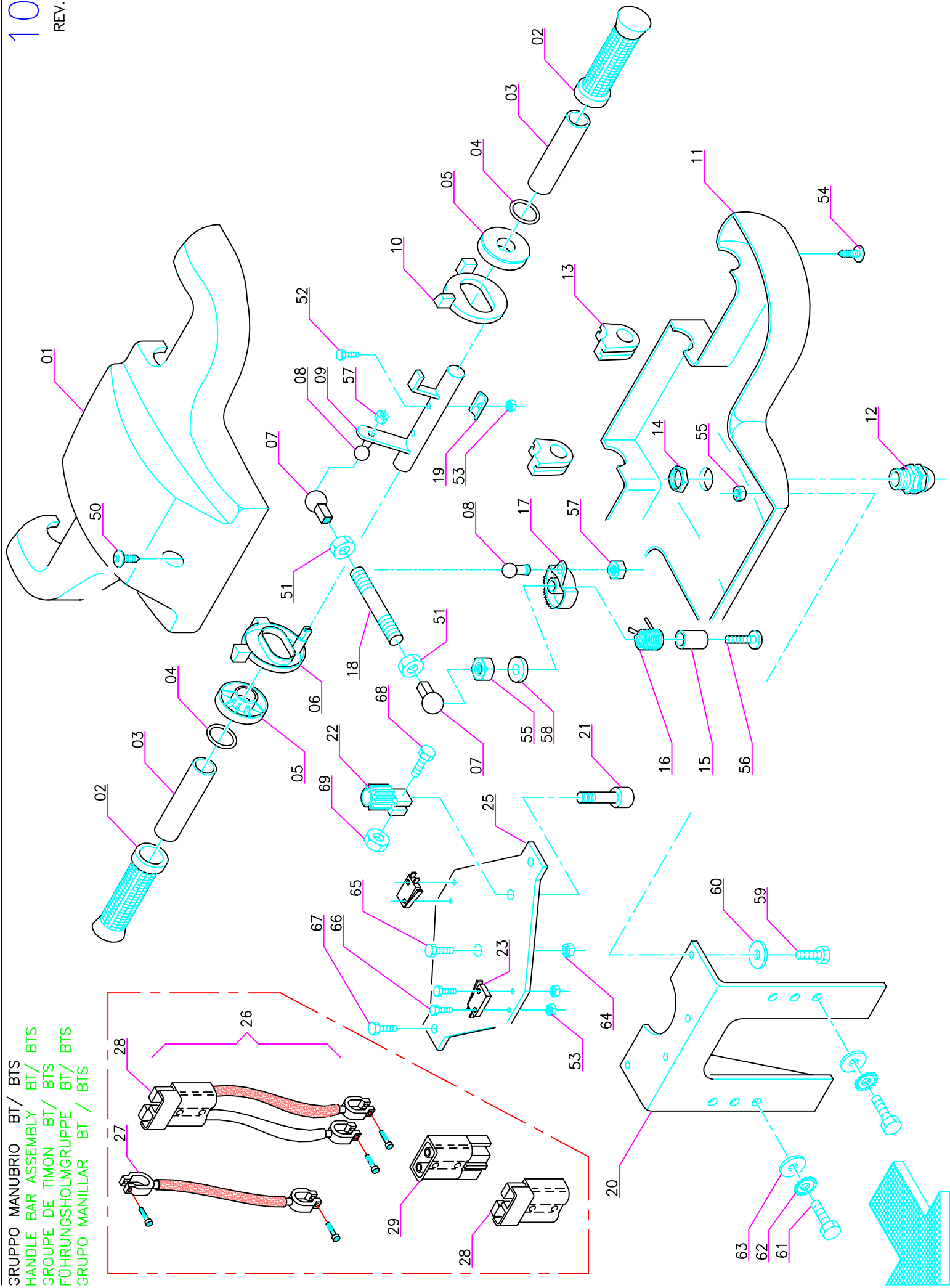

GRUPPO MANUBRIO BT/ BTS
HANDLE BAR ASSEMBLY BT/ BTS
GROUPE DE TIMON BT/ BTS
FÜHRUNGSHOLMGRUPPE BT/ BTS
GRUPO MANILLAR BT / BTS

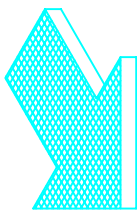

TAV.10A rev.0A GRUPPO MANUBRIO BT / BTS

Pos.	Mod.	Codice	Q.tà	Denominazione	Denomination	Description	Benennung	Description
64	-	-	-	DADO M4 UNI 5588	NUT	ECROU	MUTTER	TUERCA
65	-	-	-	VITE M4X16 UNI 5739	SCREW	VIS	SCHRAUBE	TORNILLO
66	-	-	-	VITE M3X16 UNI 7687	SCREW	VIS	SCHRAUBE	TORNILLO
67	-	-	-	VITE Ø 4,8X13 AUTOFIL, UNI 6954	SCREW	VIS	SCHRAUBE	TORNILLO
68	-	-	-	VITE M4X20 UNI 5739	SCREW	VIS	SCHRAUBE	TORNILLO
69	-	-	-	DADO M4 AUTOBL. UNI 7474	LOCK NUT	ECROU AUTOBLOQUANT	STOPMUTTER	TUERCA AUTOBLOCANTE

COMPONENTI ELETTRICI 450B 500B
 ELECTRIC COMPONENTS 450B 500B
 COMPOSANTS ELECTRIQUES 450B 500B
 ELEKTROTEILE 450B 500B
 COMPONENTES ELECTRICOS 450B 500B

11
 REV. 01

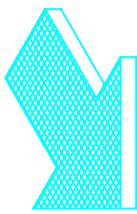
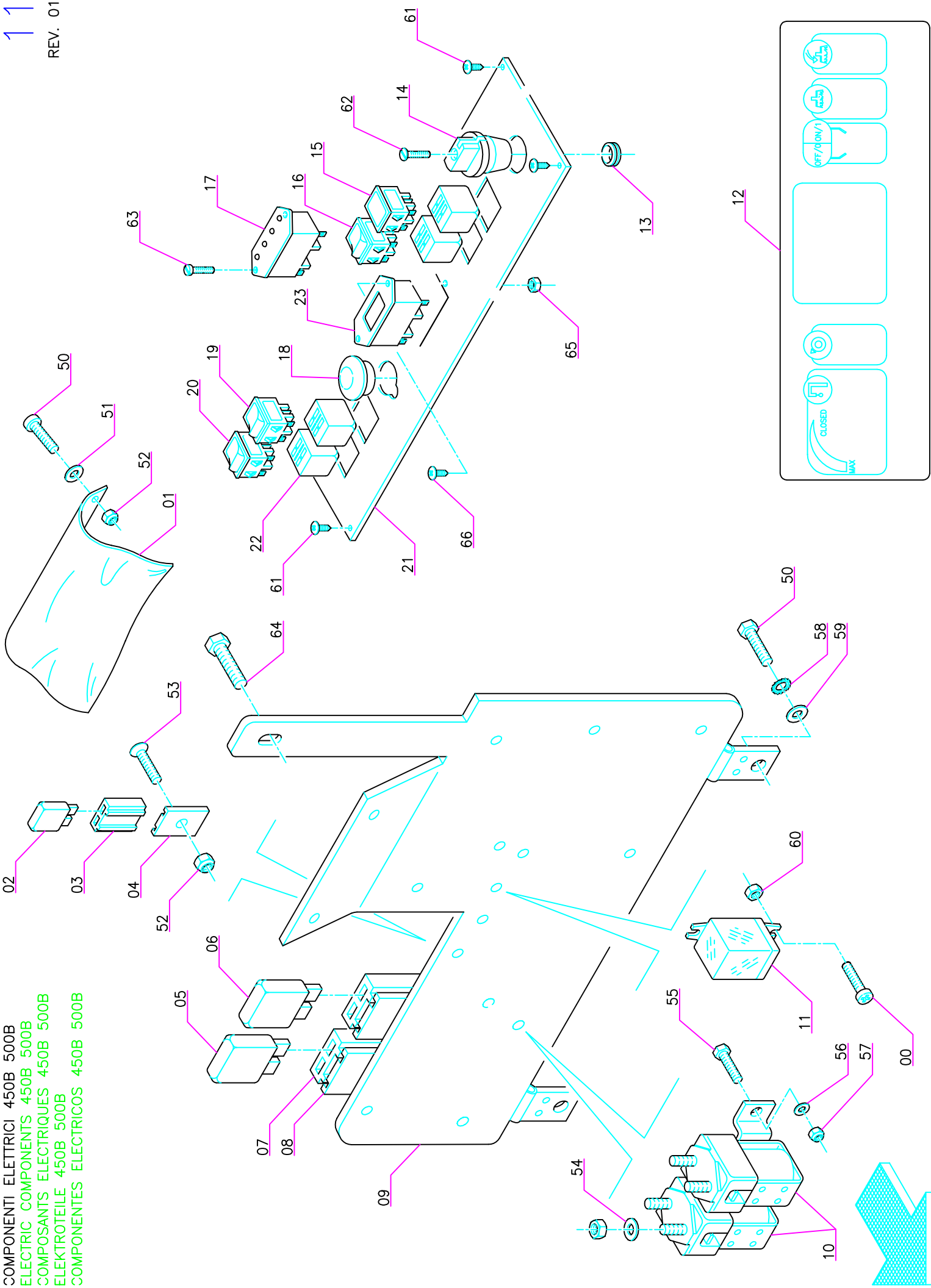

TAV.11 rev.01 GRUPPO COMPONENTI ELETTRICI 450/500B

Pos.	Mod.	Codice	Q.tà	Denominazione	Denomination	Description	Benennung	Descrpcion
1		415152	2	PROTEZIONE IMPIANTO ELETTRICO	PROTECTION	PROTECTION	ABDECKUNG	PROTECCION
2		409592	1	FUSIBILE 3A A FASTON	FUSE	FUSIBLE	SICHERUNG	FUSIBLE
3		409585	1	PORTAFUSIB. A LAMA SINGOLO	FUSEHOLDER	PORTE-FUSIBLE	SICHERUNGSHALTER	PORTAFUSIBLE
4		409869	1	PIASTRINA ATTACCO x PORTAFUSE	SUPPORT PLATE	PLAQUETTE	STÜTZPLATTE	OREJA DE APOYO
5		409607	1	MAXIFUSIBILE 30A	MAXIFUSE	MAXIFUSIBLE	MAXISICHERUNG	MAXIFUSIBLE
6		409614	1	MAXIFUSIBILE 60A	MAXIFUSE	MAXIFUSIBLE	MAXISICHERUNG	MAXIFUSIBLE
7		409586	2	PORTAMAXIFUSE CON FERMO GIALLO	FUSE BOX	BOITE A FUSIBLES	SICHERUNGDOSE	CAJA DE FUSIBLES
8		409872	2	PIASTRINA ATTACCO x PORTAMAXIF	SUPPORT PLATE	PLAQUETTE	STÜTZPLATTE	OREJA DE APOYO
9		203526	1	PANNELLO IMPIANTO ELETTRICO	PANEL	PANNEAU	PLATTE	PANEL
10		407582	2	TELERUTTORE 24V SW822-4 DOPPIO	REMOTE CONTROL SWITCH	TELERUPTEUR	SCHÜTZ	TELEINTERRUPTOR
11		407580	1	RELE FINDER 65.31 30 A, 24 V	RELAY	RELAIS	RELAIS	RELE
12		413967	1	ETIC. CRUSCOTTO MAXIMA NEUTRA	LABEL	ETIQUETTE	SCHILD	ETIQUETA
13		409810	1	PASSACAVO PER FORO D.12 Di.8	FAIRLEAD	PASSE-CABLE	KABELMUFFE	GUIACABLE
14		400332	1	MANOPOLA RUBINETTO	HANDLE	POIGNEE	GRIF	MANGO
15		409539	1	SEGNALE LUM. VERDE 24V PROT.	GREEN INDICATOR	INDICATEUR VERT	GRUNER ANZEIGER	SEGNALE VERDE
16		409483	1	INT. BIP. LUM. VERDE 24V PROT.	GREEN SWITCH	INTERRUPTEUR VERT	GRUNER SCHALTER	INTERRUPTOR VERDE
17		411729	1	SCHEDA LIV. BATTERIA LIQ/GEL	CHECK CARD BATTERIES	PLAQUE CONTROLE BATT.	KONTROLLEL. BATTERIEN	FICHA CONTROL BATTERIAS
18		409843	1	TAPPO COPRIFORO D.22	PLUG	BOUCHON	DECKEL	PORTEZUELA
19		409487	1	DEV. BIP. LUM. VERDE 24V PROT.	GREEN DIVERSION	DEVIATION VERT	GRUNER ABWEICHUNG	DESVIACION VERDE
20		415991	1	PULS. BIP. VERDE PROT.	GREEN PUSH BUTTON	PRESSE-BOUTON VERT	GRUNER KOLBEN	PULSADOR VERDE
21		203524	1	LAMIERA CRUSCOTTO	INSTRUMENT BOARD	TABEAU DE BORD	ARMATURENBREIT	TABLERO DE INSTRUMENTOS
22		409296	4	ZOCOLO POLARIZZATO	BASE	SOUBASSEMENT	SOCKEL	CHANGLO
23	*	409772	1	CONTAORE	HOUR METER	COMPTEUR HORAIRE	BETRIEBSSTUNDENZÄHLER	CUENTAHORAS
50		-	-	VITE M4X10 UNI 7687	SCREW	VIS	SCHRAUBE	TORNILLO
51		-	-	ROSETTA M4 D.12 UNI 6593	WASHER	RONDELLE	SCHEIBE	ARANDELA
52		-	-	DADO M4 AUTOBL. UNI 7474	LOCK NUT	ECROU AUTOBLOQUANT	STOPMUTTER	TUERCA AUTOBLOCANTE
53		-	-	VITE M4X12 UNI 7688	SCREW	VIS	SCHRAUBE	TORNILLO
54		-	-	ROSETTA M8 UNI 6592 OTTONE	WASHER	RONDELLE	SCHEIBE	ARANDELA
55		-	-	VITE M5X12 UNI 5739	SCREW	VIS	SCHRAUBE	TORNILLO
56		-	-	ROSETTA M5 UNI 6592	WASHER	RONDELLE	SCHEIBE	ARANDELA
57		-	-	DADO M5 AUTOBL. UNI 7474	LOCK NUT	ECROU AUTOBLOQUANT	STOPMUTTER	TUERCA AUTOBLOCANTE
58		-	-	ROSETTA M5 DIN 6798/A	LOCK WASHER	RONDELLE	ZAHNSCHEIBE	ARANDELA DENTADA
59		-	-	ROSETTA M5 D.15 UNI 6593	WASHER	RONDELLE	SCHEIBE	ARANDELA
60		-	-	DADO M4 UNI 5588	NUT	ECROU	MUTTER	TUERCA
61		-	-	VITE Ø 4.8X13 AUTOFIL. UNI 6954	SCREW	VIS	SCHRAUBE	TORNILLO
62		-	-	VITE M4X8 UNI 7688	SCREW	VIS	SCHRAUBE	TORNILLO
63		-	-	VITE M3X16 UNI 7687 A2	SCREW	VIS	SCHRAUBE	TORNILLO
64		-	-	VITE Ø 5.5X10 AUTOFIL. UNI 6954	SCREW	VIS	SCHRAUBE	TORNILLO
65		-	-	DADO M3 AUTOBL. UNI 7474	LOCK NUT	ECROU AUTOBLOQUANT	STOPMUTTER	TUERCA AUTOBLOCANTE
66	*	-	-	VITE Ø 4.2X13 AUTOFIL. UNI 6954	SCREW	VIS	SCHRAUBE	TORNILLO

* = PROFY LINE

COMPONENTI ELETTRICI 450BT 500BT
 ELECTRIC COMPONENTS 450BT 500BT
 COMPOSANTS ELECTRIQUES 450BT 500BT
 ELEKTROTEILE 450BT 500BT
 COMPONENTES ELECTRICOS 450BT 500BT

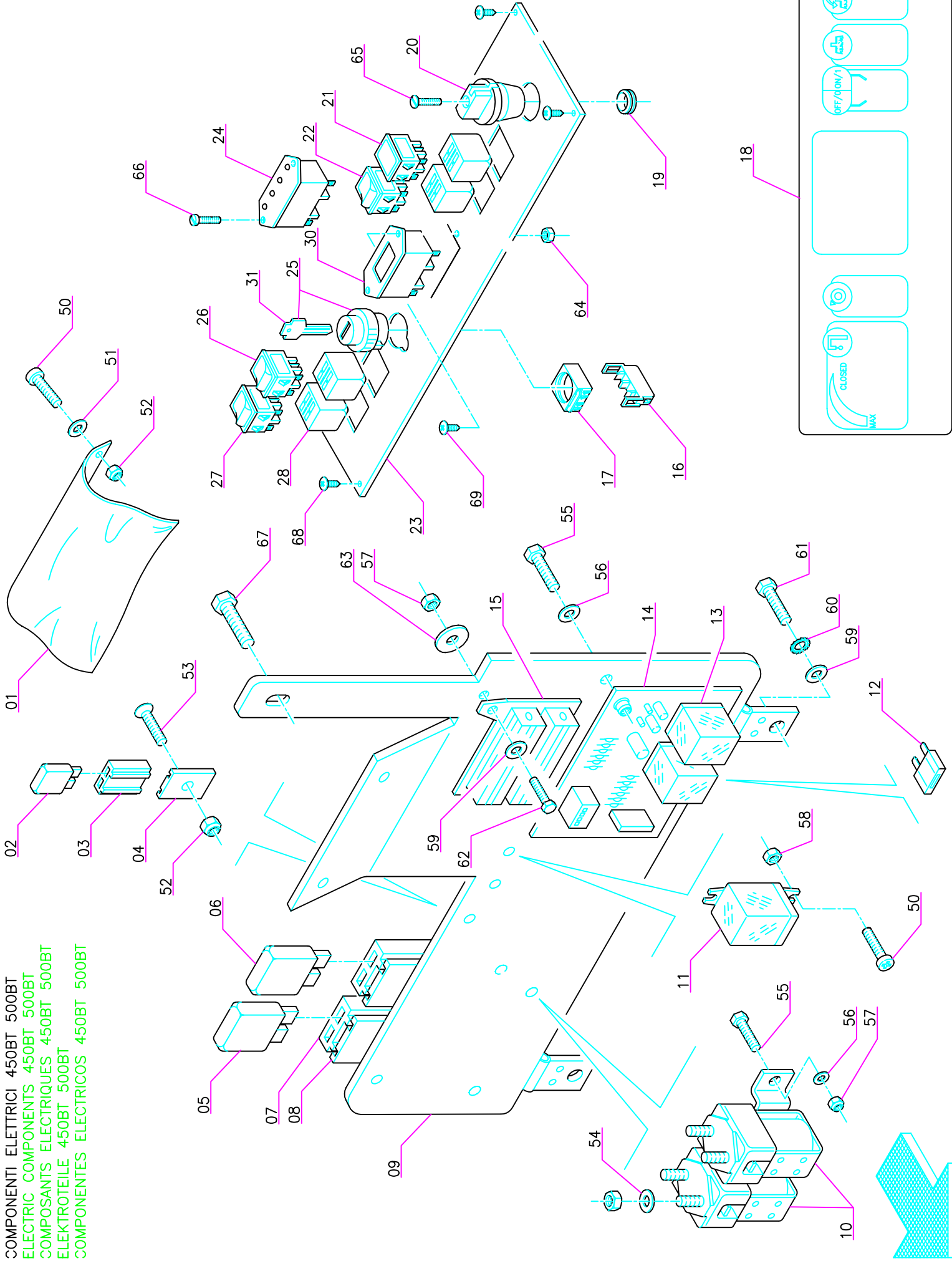

Pos.	Mod.	Codice	Q.tà	Denominazione	Denomination	Description	Benennung	Descrpcion
1		415152	2	PROTEZIONE IMPIANTO	PROTECTION	PROTECTION	ABDECKUNG	PROTECCION
2		409592	1	FUSIBILE 3A A FASTON	FUSE	FUSIBLE	SICHERUNG	FUSIBLE
3		409585	1	PORTAFUSIB. A LAMA SINGOLO	FUSEHOLDER	PORTE-FUSIBLE	SICHERUNGSHALTER	PORTAFUSIBLE
4		409869	1	PIASTRINA ATTACCO	SUPPORT PLATE	PLAQUETTE	STÜTZPLATTE	OREJA DE APOYO
5		409607	1	MAXIFUSIBILE 30A	MAXIFUSE	MAXIFUSIBLE	MAXISICHERUNG	MAXIFUSIBLE
6		409614	1	MAXIFUSIBILE 60A	MAXIFUSE	MAXIFUSIBLE	MAXISICHERUNG	MAXIFUSIBLE
7		409586	2	PORTAMAXIFUSE CON FERMO	FUSE BOX	BOITE A FUSIBLES	SICHERUNGDOSE	CAJA DE FUSIBLES
8		409872	2	PIASTRINA ATTACCO	SUPPORT PLATE	PLAQUETTE	STÜTZPLATTE	OREJA DE APOYO
9		203526	1	PANNELLO IMPIANTO ELETTRICO	PANEL	PANNEAU	PLATTE	PANEL
10		407582	1	TELERUTTORE 24V DOPPIO	REMOTE CONTROL SWITCH	TELERUPTEUR	SCHÜTZ	TELEINTERRUPTOR
11		407580	1	RELE 24V	RELAY	RELAIS	RELAIS	RELE
12		409605	1	FUSIBILE 30A	FUSE	FUSIBLE	SICHERUNG	FUSIBLE
13		407581	2	RELE FINDER 24V	RELAY	RELAIS	RELAIS	RELE
14		414527	1	SCHEDA CHOPPER	CHOPPER CARD	VARIATEUR ELECTRONIQUE	ELEKTRONIKKARTE	FICHA-CHOPPER
15		416025	2	RESISTENZA DI FRENATURA 2Ω	BRAKING RESISTANCE	RESISTANCE DE FREINAGE	WIDERSTANDBREMSUNG	RESISTENCIAS FRENADO
16		409246	1	CONTATTO PER INT. A CHIAVE	CONTACT	CONTACT	KONTAKT	CONTACTO
17		409262	1	FLANGIA PER CONTATTO	FLANGE	FLASQUE	FLANSCH	BRIDA
18		413967	1	ETIC. CRUSCOTTO	ETIC. CRUSCOTTO MAXIMA NEUTRA	LABEL	ETIQUETTE	SCHILD
19		409810	1	PASSACAVO PER FORO	PASSACAVO PER FORO D.12 Di.8	FAIRLEAD	PASSE-CABLE	KABELMUFFE
20		400332	1	MANOPOLA RUBINETTO	MANOPOLA RUBINETTO	HANDLE	POIGNEE	GRIFF
21		409539	1	SEGNALE LUM. VERDE 24V	SEGNALE LUM. VERDE 24V PROT.	GREEN INDICATOR	INDICATEUR VERT	GRUNER ANZEIGER
22		409483	1	INT. BIP. LUM. VERDE 24V	INT. BIP. LUM. VERDE 24V PROT.	GREEN SWITCH	INTERRUPTEUR VERT	GRUNER SCHALTER
23		203524	1	LAMIERA CRUSCOTTO	INSTRUMENT BOARD	TABLEAU DE BORD	ARMATURENBRETT	TABLERO DE INSTRUMENTOS
24		411729	1	SCHEDA LIV. BATTERIA	CHECK CARD BATTERIES	PLAQUE CONTROLE BATT.	KONTROLLEL. BATTERIEN	FICHA CONTROL BATTERIAS
25		409261	1	CORPO INTERRUTTORE+CHIAVE	SWITCH WITH KEY	INTERRUPTEUR AVEC CLE	SCHALTER MIT SCHLUSSER	INTERRUPTOR CON LLAVE
26		409487	1	DEV. BIP. LUM. VERDE 24V PROT.	GREEN DIVERSION	DEVIATION VERT	GRUNER ABWEICHUNG	DESVIACION VERDE
27		415991	1	PULS. BIP. VERDE PROT.	GREEN PUSH BUTTON	PRESSE-BOUTON VERT	GRUNER KOLBEN	PULSADOR VERDE
28		409296	4	ZOCOLO POLARIZZATO	BASE	SOUBASSEMENT	SOCKEL	CHANCLO
29		409772	1	CONTAORE	HOOR METER	COMPTEUR HORAIRE	BETRIEBSSTUNDENZÄHLE	CUENTAHORAS
30	*	409772	1	CONTAORE	HOOR METER	COMPTEUR HORAIRE	BETRIEBSSTUNDENZÄHL	CUENTAHORAS
31		409297	1	CHIAVE	KEY	CLAVE	KEIL	LLAVE
50		-	-	VITE M4X10 UNI 7687	SCREW	VIS	SCHRAUBE	TORNILLO
51		-	-	ROSETTA M4 D.12 UNI 6593	WASHER	RONDELLE	SCHEIBE	ARANDELA
52		-	-	DADO M4 AUTOBL. UNI 7474	LOCK NUT	ECROU AUTOBLOQUANT	STOPMUTTER	TUERCA AUTOBLOCANTE
53		-	-	VITE M4X12 UNI 7688	SCREW	VIS	SCHRAUBE	TORNILLO
54		-	-	ROSETTA M8 UNI 6592 OTTONE	WASHER	RONDELLE	SCHEIBE	ARANDELA
55		-	-	VITE M5X12 UNI 5739	SCREW	VIS	SCHRAUBE	TORNILLO
56		-	-	ROSETTA M5 UNI 6592	WASHER	RONDELLE	SCHEIBE	ARANDELA
57		-	-	DADO M5 AUTOBL. UNI 7474	LOCK NUT	ECROU AUTOBLOQUANT	STOPMUTTER	TUERCA AUTOBLOCANTE
58		-	-	DADO M4 UNI 5588	NUT	ECROU	MUTTER	TUERCA
59		-	-	ROSETTA M5 D.15 UNI 6593	WASHER	RONDELLE	SCHEIBE	ARANDELA
60		-	-	ROSETTA M5 DIN 6798/A	LOCK WASHER	RONDELLE	ZAHNSCHEIBE	ARANDELA DENTADA

COMPONENTI ELETTRICI 450BT 500BT
 ELECTRIC COMPONENTS 450BT 500BT
 COMPOSANTS ELECTRIQUES 450BT 500BT
 ELEKTROTEILE 450BT 500BT
 COMPONENTES ELECTRICOS 450BT 500BT

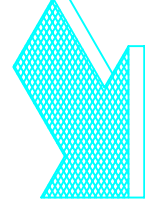
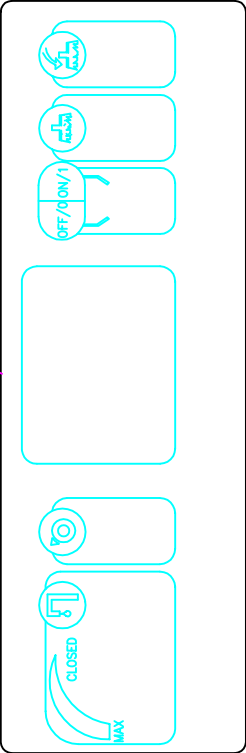
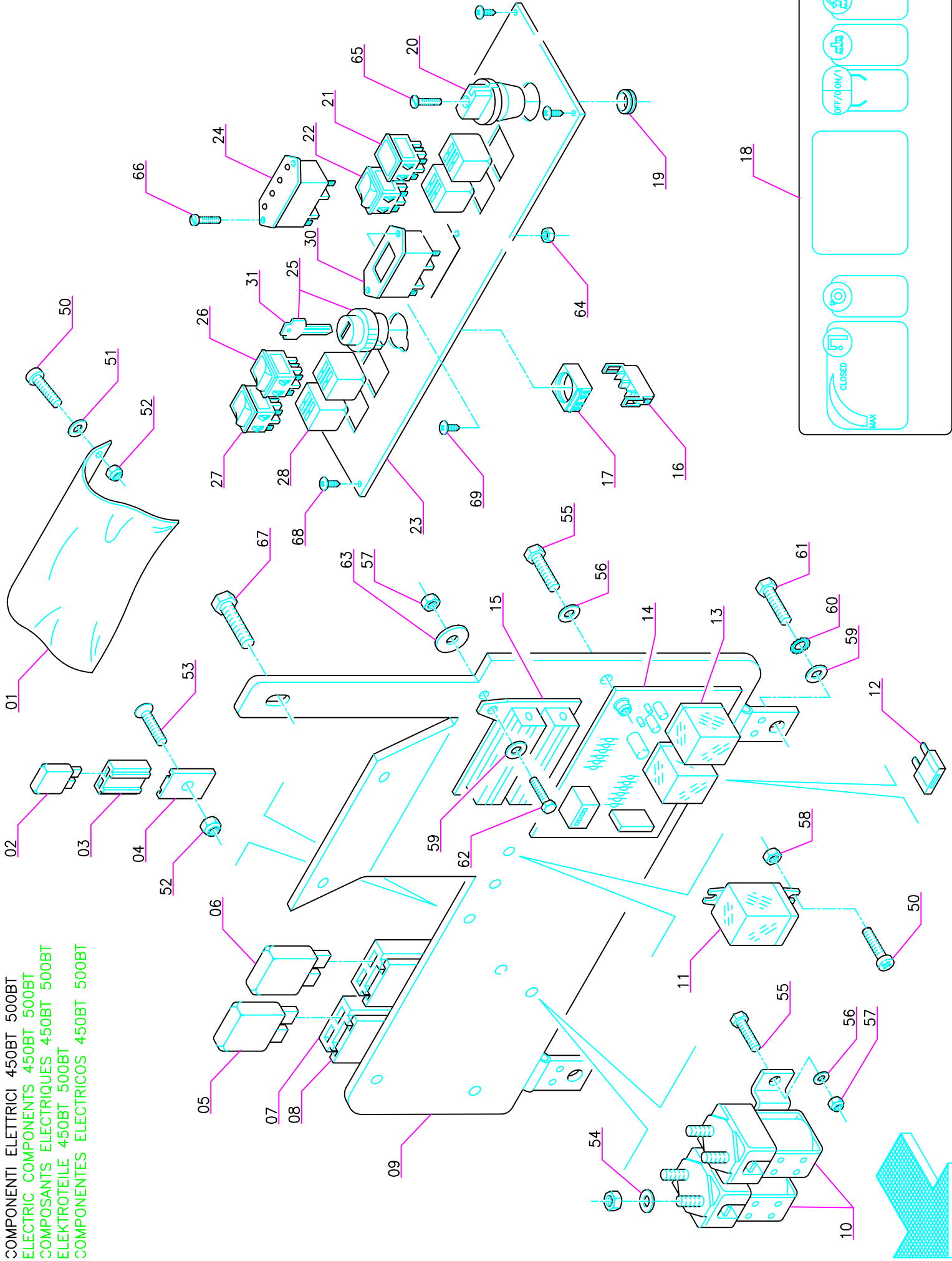

TAV.11A rev.01 GRUPPO COMPONENTI ELETTRICI 450/500BT

Pos. Mod.	Codice	Q.tà	Denominazione	Denomination	Description	Benennung	Description
61	-	-	VITE M5X16 UNI 5739	SCREW	VIS	SCHRAUBE	TORNILLO
62	-	-	VITE M5X30 UNI 5739	SCREW	VIS	SCHRAUBE	TORNILLO
63	-	-	ROSETTA M5 D.20 UNI 6593	WASHER	RONDELLE	SCHEIBE	ARANDELA
64	-	-	DADO M3 AUTOBL. UNI 7474	LOCK NUT	ECROU AUTOBLOQUANT	STOPMUTTER	TUERCA AUTOBLOCANTE
65	-	-	VITE M4X8 UNI 7688	SCREW	VIS	SCHRAUBE	TORNILLO
66	-	-	VITE M3X16 UNI 7687 A2	SCREW	VIS	SCHRAUBE	TORNILLO
67	-	-	VITE Ø 5,5X10 UNI 6954 A2	SCREW	VIS	SCHRAUBE	TORNILLO
68	-	-	VITE Ø 4,8X13 UNI 6954	SCREW	VIS	SCHRAUBE	TORNILLO
69	*	-	VITE Ø 4,2X13 UNI 6954	SCREW	VIS	SCHRAUBE	TORNILLO

* = PROFY LINE

COMPONENTI ELETTRICI 452-502 B / 45-50 BS
 ELECTRIC COMPONENTS 452-502 B / 45-50 BS
 COMPOSANTS ELECTRIQUES 452-502 B / 45-50 BS
 ELEKTROTEILE 452-502 B / 45-50 BS
 COMPONENTES ELECTRICOS 452-502 B / 45-50 BS

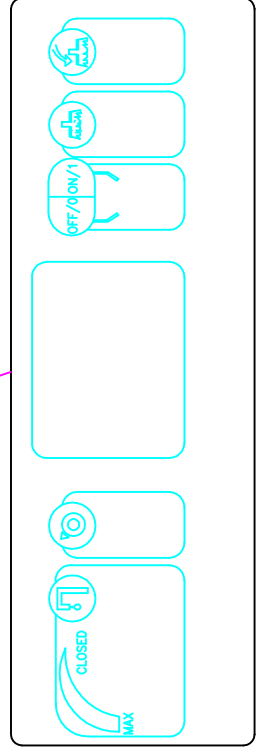
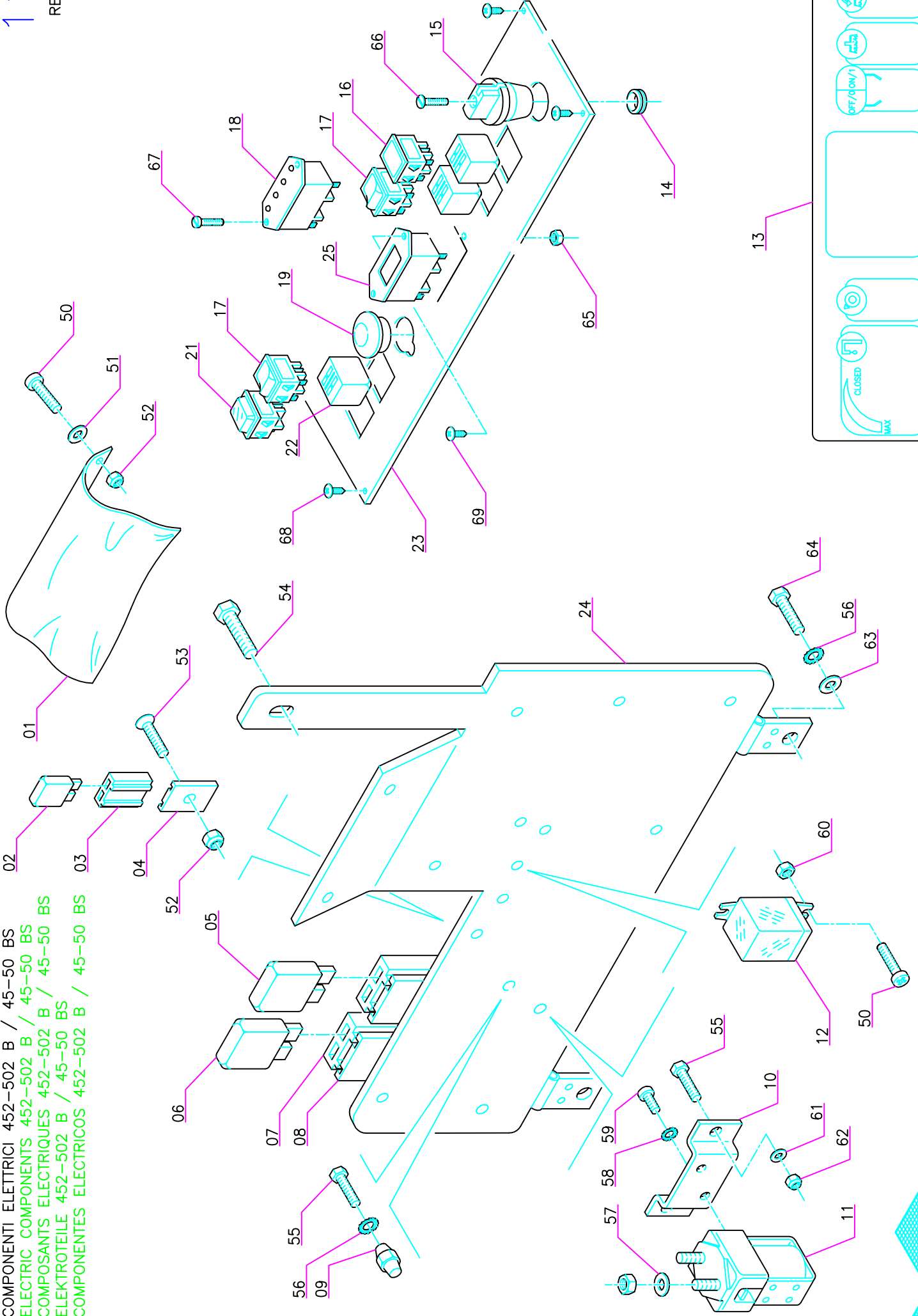

Pos.	Mod.	Codice	Q.tà	Denominazione	Denomination	Description	Benennung	Description
1		415152	2	PROTEZIONE IMPIANTO ELETTRICO	PROTECTION	PROTECTION	ABDECKUNG	PROTECCION
2		409592	1	FUSIBILE 3A A FASTON	FUSE	FUSIBLE	SICHERUNG	FUSIBLE
3		409585	1	PORTAFUSIB. A LAMA SINGOLO	FUSEHOLDER	PORTE-FUSIBLE	SICHERUNGSHALTER	PORTAFUSIBLE
4		409869	1	PIASTRINA	SUPPORT PLATE	PLAQUETTE	STÜTZPLATTE	OREJA DE APOYO
5		409614	1	MAXIFUSIBILE 60A	MAXIFUSE	MAXIFUSIBLE	MAXISICHERUNG	MAXIFUSIBLE
6		409607	1	MAXIFUSIBILE 30A	MAXIFUSE	MAXIFUSIBLE	MAXISICHERUNG	MAXIFUSIBLE
7		409586	2	PORTAMAXIFUSE CON FERMO	FUSE BOX	BOITE A FUSIBLES	SICHERUNGDOSE	CAJA DE FUSIBLES
8		409872	2	PIASTRINA	SUPPORT PLATE	PLAQUETTE	STÜTZPLATTE	OREJA DE APOYO
9		409767	1	ISOLATOR	INSULATOR	ISOLATEUR	ISOLATOR	ISOLADOR
10		409270	1	STAFFA TELERUTTORE	SUPPORT	SUPPORT	HALTERUNG	SOPORTE FIADOR
11		407576	1	TELERUTTORE 24V	REMOTE CONTROL SWITCH	TELERUPTEUR	SCHÜTZ	TELEINTERRUPTOR
12		407580	1	RELE FINDER 30A 24V	RELAY	RELAIS	RELAIS	RELE
13		413967	1	ETIC. CRUSCOTTO	LABEL	ETIQUETTE	SCHILD	ETIQUETA
14		409810	1	PASSACAVO	FAIRLEAD	PASSE-CABLE	KABELMUFFE	GUJACABLE
15		400332	1	MANOPOLA RUBINETTO	HANDLE	POIGNEE	GRIF	MANGO
16		409539	1	SEGNALE LUM. VERDE 24V	GREEN INDICATOR	INDICATEUR VERT	GRUNER ANZEIGER	SEGNAL VERDE
17		409483	2	INT. BIP. LUM. VERDE 24V	GREEN SWITCH	INTERRUPTEUR VERT	GRUNER SCHALTER	INTERRUPTOR VERDE
18		411729	1	SCHEDA LIV. BATTERIA	CHECK CARD BATTERIES	PLAQUE CONTROLE BATT.	KONTROLLEL. BATTERIEN	FICHA CONTROL BATTERIAS
19		409843	1	TAPPO COPRIFORO	PLUG	BOUCHON	DECKEL	PORTEZUELA
21		409566	1	COPRIFORO NERO	PLUG	BOUCHON	DECKEL	PORTEZUELA
22		409296	3	ZOCCOLO POLARIZZATO	BASE	SOUBASSEMENT	SOCKEL	CHANCLO
23		203524	1	LAMIERA CRUSCOTTO	INSTRUMENT BOARD	TABLEAU DE BORD	ARMATURENBRETT	TABLERO DE INSTRUMENTOS
24		203526	1	PANNELLO IMPIANTO ELETTRICO	PANEL	PANNEAU	PLATTE	PANEL
25	*	409772	1	CONTAORE	HOUR METER	COMPTEUR HORAIRE	BETRIEBSSTUNDENZÄHLE	CUENTAHORAS
50		-	-	VITE M4X10 UNI 7687	SCREW	SCREW	SCHRAUBE	TORNILLO
51		-	-	ROSETTA M4 D.12 UNI 6593	WASHER	RONDELLE	SCHEIBE	ARANDELA
52		-	-	DADO M4 AUTOBL. UNI 7474	LOCK NUT	ECROU AUTOBLOQUANT	STOPMUTTER	TUERCA AUTOBLOCANTE
53		-	-	VITE M4X12 UNI 7688	SCREW	SCREW	SCHRAUBE	TORNILLO
54		-	-	VITE Ø 5.5X10 UNI 6954 A2	SCREW	SCREW	SCHRAUBE	TORNILLO
55		-	-	VITE M5X12 UNI 5739	SCREW	SCREW	SCHRAUBE	TORNILLO
56		-	-	ROSETTA M5 DIN 6798/A	LOCK WASHER	RONDELLE	ZAHNSCHEIBE	ARANDELA DENTADA
57		-	-	ROSETTA M8 UNI 6592 OTTONE	WASHER	RONDELLE	SCHEIBE	ARANDELA
58		-	-	ROSETTA M4 DIN 6798/A	LOCK WASHER	RONDELLE	ZAHNSCHEIBE	ARANDELA DENTADA
59		-	-	VITE M4X6 UNI 7687	SCREW	SCREW	SCHRAUBE	TORNILLO
60		-	-	DADO M4 UNI 5588	NUT	ECROU	MUTTER	TUERCA
61		-	-	ROSETTA M5 UNI 6592	WASHER	RONDELLE	SCHEIBE	ARANDELA
62		-	-	DADO M5 AUTOBL. UNI 7474	LOCK NUT	ECROU AUTOBLOQUANT	STOPMUTTER	TUERCA AUTOBLOCANTE
63		-	-	ROSETTA M5 D.15 UNI 6593	WASHER	RONDELLE	SCHEIBE	ARANDELA
64		-	-	VITE M5X16 UNI 5739	SCREW	SCREW	SCHRAUBE	TORNILLO
65		-	-	DADO M3 AUTOBL. UNI 7474	LOCK NUT	ECROU AUTOBLOQUANT	STOPMUTTER	TUERCA AUTOBLOCANTE
66		-	-	VITE M4X8 UNI 7688	SCREW	SCREW	SCHRAUBE	TORNILLO
67		-	-	VITE M3X16 UNI 7687 A2	SCREW	SCREW	SCHRAUBE	TORNILLO

COMPONENTI ELETTRICI 452-502 B / 45-50 BS
 ELECTRIC COMPONENTS 452-502 B / 45-50 BS
 COMPOSANTS ELECTRIQUES 452-502 B / 45-50 BS
 ELEKTROTEILE 452-502 B / 45-50 BS
 COMPONENTES ELECTRICOS 452-502 B / 45-50 BS

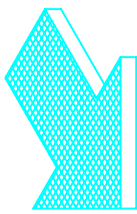
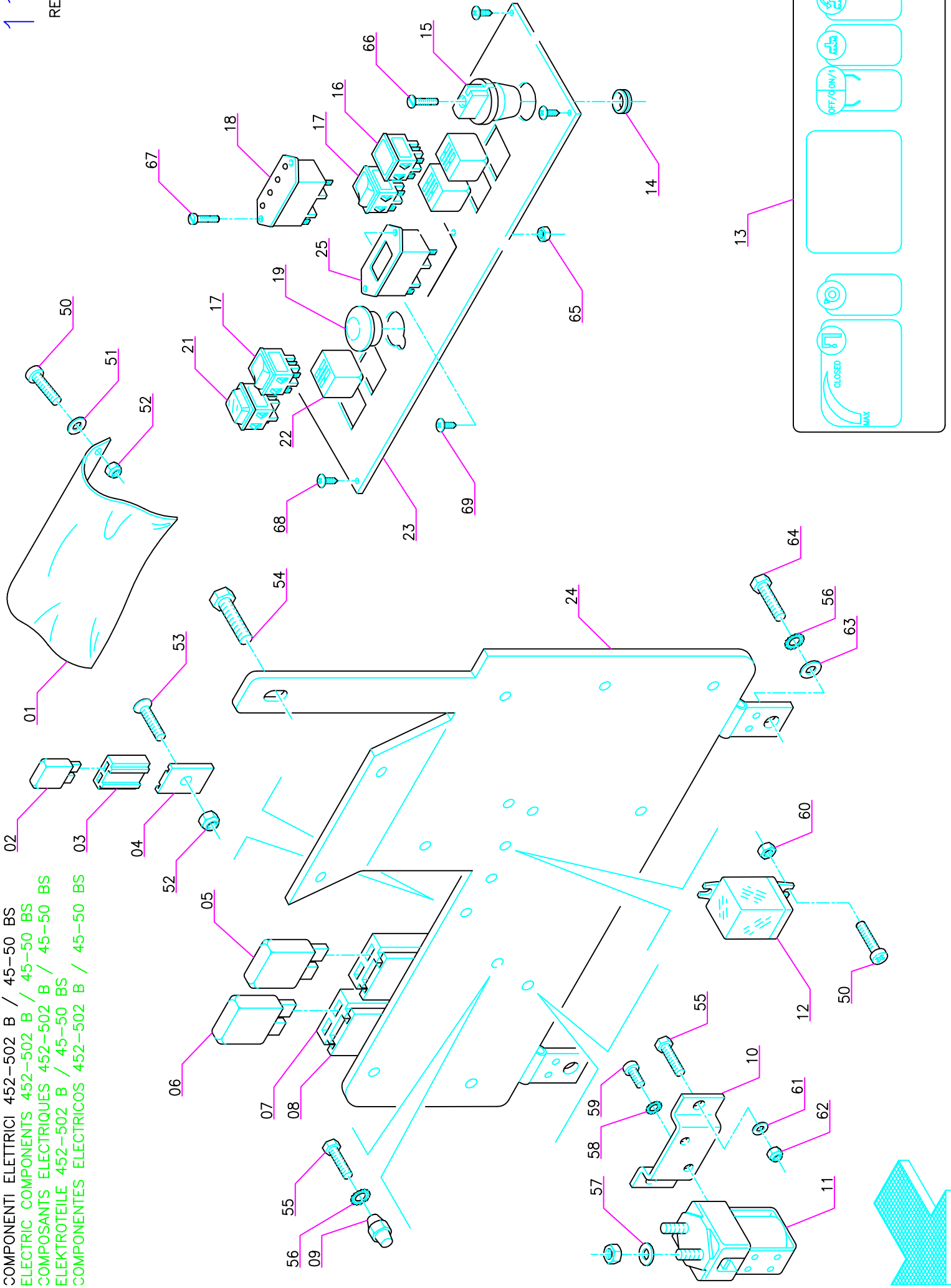



TAV.11B rev.01 GRUPPO COMPONENTI ELETTRICI 452-502 B / 45-50 BS

Pos.	Mod.	Codice	Q.tà	Denominazione	Denomination	Description	Benennung	Description
68		-	-	VITE Ø 4,8X13 AUTOFIL. UNI 6954	SCREW	VIS	SCHRAUBE	TORNILLO
69	*	-	-	VITE Ø 4,2X13 AUTOFIL. UNI 6954	SCREW	VIS	SCHRAUBE	TORNILLO

* = 452-502B PROFY LINE ;502B KLINIK LINE ;45BS INDY LINE

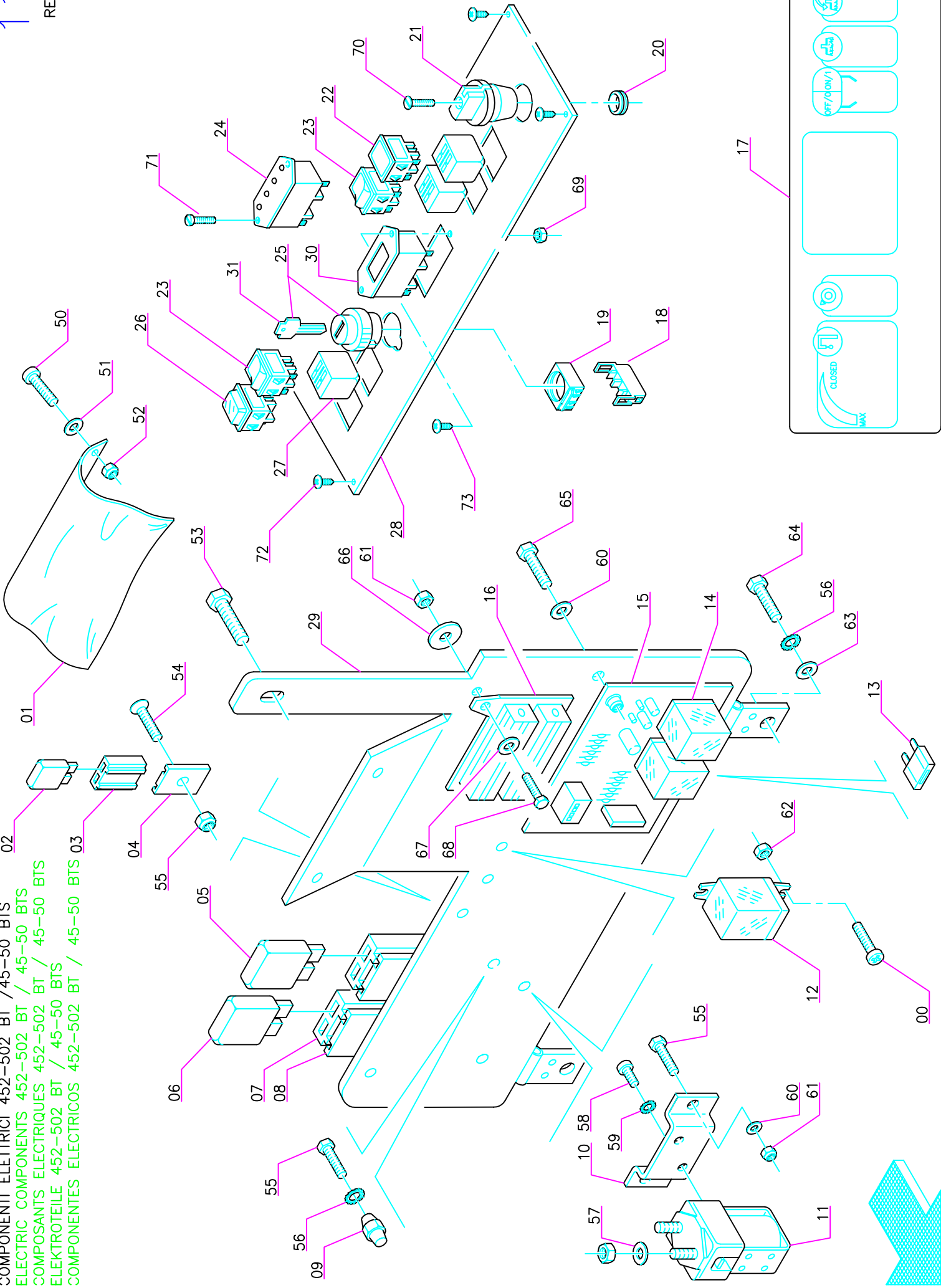
COMPONENTI ELETTRICI 452-502 BT / 45-50 BTS
 ELECTRIC COMPONENTS 452-502 BT / 45-50 BTS
 COMPOSANTS ELECTRIQUES 452-502 BT / 45-50 BTS
 ELEKTROTEILE 452-502 BT / 45-50 BTS
 COMPONENTES ELECTRICOS 452-502 BT / 45-50 BTS







MAX



CLOSED



OFF/ON/1



ON/OFF

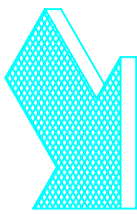

Pos.	Mod.	Codice	Q.tà	Denominazione	Denomination	Description	Benennung	Descrizione
1		415152	2	PROTEZIONE	PROTECTION	PROTECTION	SCHUTZ	PROTECCION
2		409592	1	FUSIBILE 3A	FUSE	FUSIBLE	SICHERUNG	FUSIBLE
3		409585	1	PORTAFUSIBILE	FUSE BOX	BOITE A FUSIBLES	SICHERUNGDOSE	CAJA DE FUSIBLES
4		409869	1	PIASTRINA	PLATE	PLAQUE	TELLER	PLACA
5		409614	1	MAXIFUSIBILE 60A	MAXIFUSE	MAXIFUSIBLE	MAXISICHERUNG	MAXIFUSIBLE
6		409607	1	MAXIFUSIBILE 30A	MAXIFUSE	MAXIFUSIBLE	MAXISICHERUNG	MAXIFUSIBLE
7		409586	2	CORPO PORTAMAXIFUSIBILE	MAXIFUSE HOLDER	PORTE MAXIFUSIBLE	MAXISICHERUNGSLAGER	PORTA MAXIFUSIBLE
8		409872	2	PIASTRINA PORTAFUSIBILE	PLATE	PLAQUE	TELLER	PLACA
9		409767	1	ISOLATORE	INSULATOR	ISOLATEUR	ISOLATOR	ISOLADOR
10		409270	1	STAFFA TELERUTTORE	SUPPORT	ATTAQUE	HALTERUNG	SOPORTE FIJADOR
11		407576	1	TELERUTTORE	REMOTE CONTROL	TELERUPTEUR	FERNSTEUR	CONTROL REMOTO
12		407580	1	RELE'	RELAY	RELAIS	RELAIS	RELE
13		409605	1	FUSIBILE 30A	FUSE	FUSIBLE	SICHERUNG	FUSIBLE
14		407581	2	RELE'	RELAY	RELAIS	RELAIS	RELE
15		414527	1	SCHEDA CHOPPER	CHOPPER CARD	VARIATEUR ELECTRONIQUE	ELEKTRONIKKARTE	FICHA-CHOPPER
16		416025	2	RESISTENZE	RESISTANCE	RESISTANCE	WINDERSTAND	RESISTENCIA
17		413967	1	ETICHETTA	LABEL	EIQUETTE	SCHILD	ETIQUETA
18		409246	1	CONTATTO	CONTACT	CONTACT	KONTAKT	CONTACTO
19		409262	1	FLANGIA PER CONTATTO	FLANGE	FLASQUE	FLANSH	BRIDA
20		409810	1	PASSACAVO	FAIRLEAD	PASSE-CABLE	KABELMUFFE	GUIACABILE
21		400332	1	MANOPOLA RUBINETTO	HANDLE	POIGNEE	GRIFF	MANGO
22		409539	1	SEGNALE VERDE 24V	GREEN INDICATOR	INDICATEUR VERT	GRUNER ANZEIGER	SEGNAL VERDE
23		409483	2	INTERRUTTORE VERDE 24V	GREEN SWITCH	INTERRUPTEUR VERT	GRUNER SCHALTER	INTERRUPTOR VERDE
24		411729	1	SCHEDA LIVELLO BATTERIA 24V	CARD	FICHE	KARTE	FICHA
25		409261	1	INTERRUTTORE CON CHIAVE	SWITCH WITH KEY	INTERRUPTEUR AVEC CLE	SCHALTER MIT SCHLUSSER	INTERRUPTOR CON LLAVE
26		409566	1	CORPIFORO	PLUG	BOUCHON	DECKEL	TAPON
27		409296	3	ZOCOLO POLARIZZATO	BASE	SOUBASSEMENT	SOCKEL	CHANCLO
28		203524	1	LAMIERA CRUSCOTTO	SHEET	TOLE	BLECH	CHAPA
29		203526	1	PANNELLO IMPIANTO ELETTTRICO	PANNEL	PANNEAU	TAFEL	PANEL
30	*	409772	1	CONTAORE	HOUR METER	COMPTEUR HORAIRE	BETRIEBSSTUNDENZÄHLER	CUENTAHORAS
31		409297	1	CHIAVE	KEY	CLAVE	KEIL	LLAVE
50		-	-	VITE M4X10 UNI7687	SCREW	VIS	SCHRAUBE	TORNILLO
51		-	-	RONDELLA M4 D.12 UNI 6593	WASHER	RONDELLE	SCHRAUBE	TORNILLO
52		-	-	DADO M4 AUTOBL. UNI 7474	LOCK NUT	ECROU AUTOBLOQUANT	SCHRAUBE	ARANDELA
53		-	-	VITE Ø 5,5X10 AUTOFIL UNI 6954 A2	SCREW	VIS	SCHRAUBE	TORNILLO
54		-	-	VITE M4X12 UNI 7688	SCREW	VIS	SCHRAUBE	ARANDELA
55		-	-	VITE M5X12 UNI5739	SCREW	VIS	SCHRAUBE	TORNILLO
56		-	-	RONDELLA M5 DIN 6798/A	LOCK WASHER	RONDELLE	ZAHNSCHEIBE	ARANDELA DENTADA
57		-	-	RONDELLA M8 UNI 6592 OTTONE	WASHER	RONDELLE	SCHIBE	ARANDELA
58		-	-	VITE M4X6 UNI 7687	SCREW	VIS	SCHRAUBE	TORNILLO
59		-	-	RONDELLA M4 DIN 6798/A	LOCK WASHER	RONDELLE	ZAHNSCHEIBE	ARANDELA DENTADA
60		-	-	RONDELLA M5 UNI 6592	WASHER	RONDELLE	SCHIBE	ARANDELA

COMPONENTI ELETTRICI 452-502 BT / 45-50 BTS
 ELECTRIC COMPONENTS 452-502 BT / 45-50 BTS
 COMPOSANTS ELECTRIQUES 452-502 BT / 45-50 BTS
 ELEKTROTEILE 452-502 BT / 45-50 BTS
 COMPONENTES ELECTRICOS 452-502 BT / 45-50 BTS

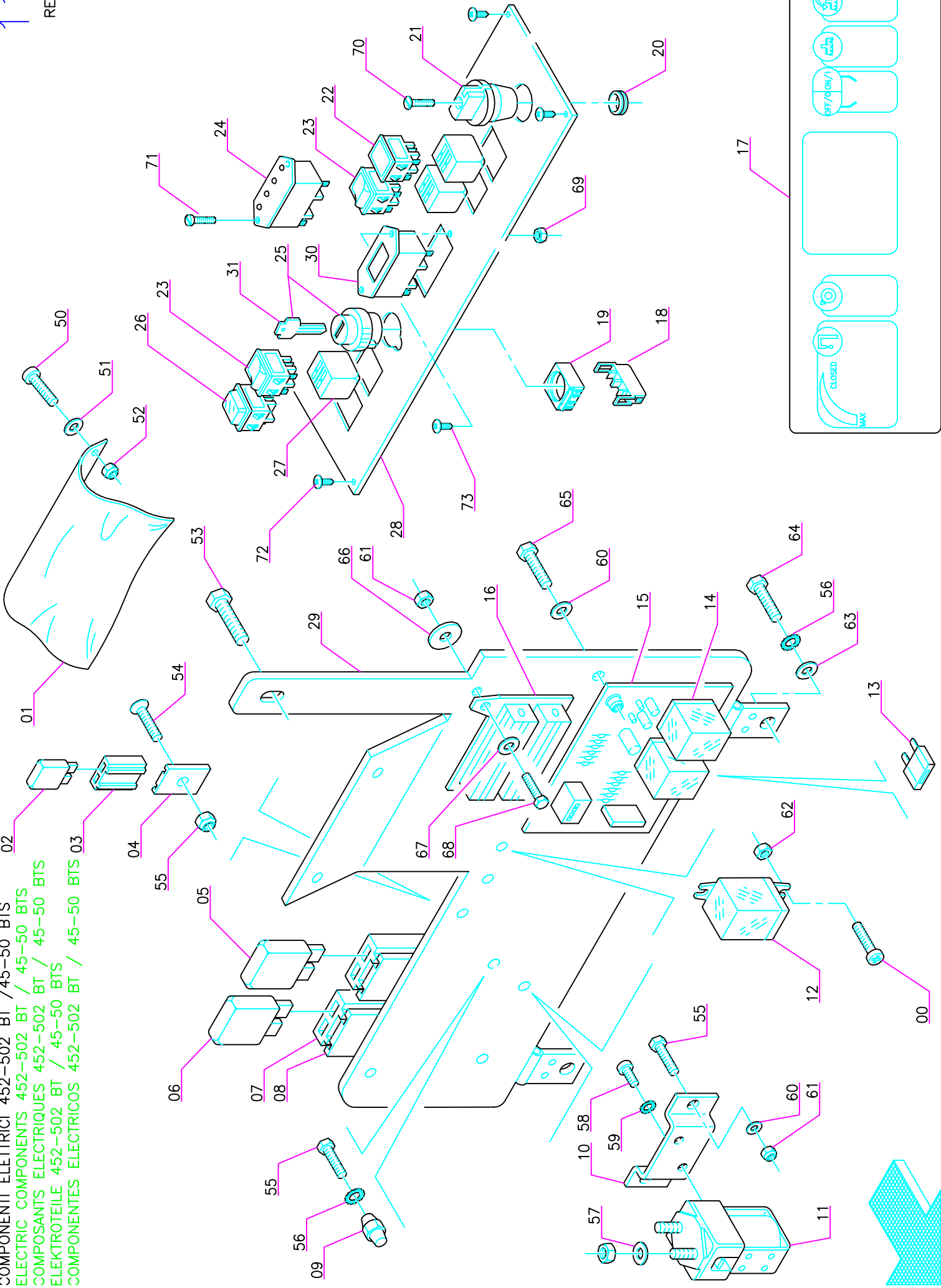
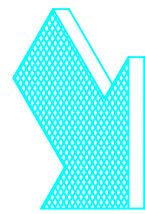



TAV.11C rev.01 GRUPPO COMPONENTI ELETTRICI 452-502 BT / 45-50 BTS

Pos.	Mod.	Codice	Q.tà	Denominazione	Denomination	Description	Benennung	Description
61	-	-	-	DADO M5 AUTOBL. UNI 7474	LOCK NUT	ECROU AUTOBLOQUANT	STOPMUTTER	TUERCA AUTOBLOCANTE
62	-	-	-	DADO M4 UNI 5588	NUT	ECROU	MUTTER	ARANDELA
63	-	-	-	RONDELLA M5 D.15 UNI 6593	WASHER	RONDELLE	SCHEIBE	ARANDELA
64	-	-	-	VITE M5X16 UNI 5739	SCREW	VIS	SCHRAUBE	TORNILLO
65	-	-	-	VITE M5X12 UNI 5739	SCREW	VIS	SCHRAUBE	TORNILLO
66	-	-	-	RONDELLA M5 D.20 UNI 6593	WASHER	RONDELLE	SCHEIBE	ARANDELA
67	-	-	-	RONDELLA M5 D.15 UNI 6593	WASHER	RONDELLE	SCHEIBE	ARANDELA
68	-	-	-	VITE M5X30 UNI 5739	SCREW	VIS	SCHRAUBE	TORNILLO
69	-	-	-	DADO M3 AUTOBL. UNI 7474	LOCK NUT	ECROU AUTOBLOQUANT	STOPMUTTER	TUERCA AUTOBLOCANTE
70	-	-	-	VITE M4X8 UNI 7688	SCREW	VIS	SCHRAUBE	TORNILLO
71	-	-	-	VITE M3X16 UNI 7687 A2	SCREW	VIS	SCHRAUBE	TORNILLO
72	-	-	-	VITE Ø 4,8X13 AUTOFIL. UNI 6954	SCREW	VIS	SCHRAUBE	TORNILLO
73	*	-	-	VITE Ø 4,2X13 AUTOFIL. UNI 6954	SCREW	VIS	SCHRAUBE	TORNILLO

* = 452-502BT PROFY LINE ;45BTS INDY LINE

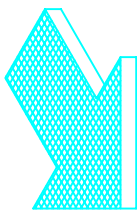
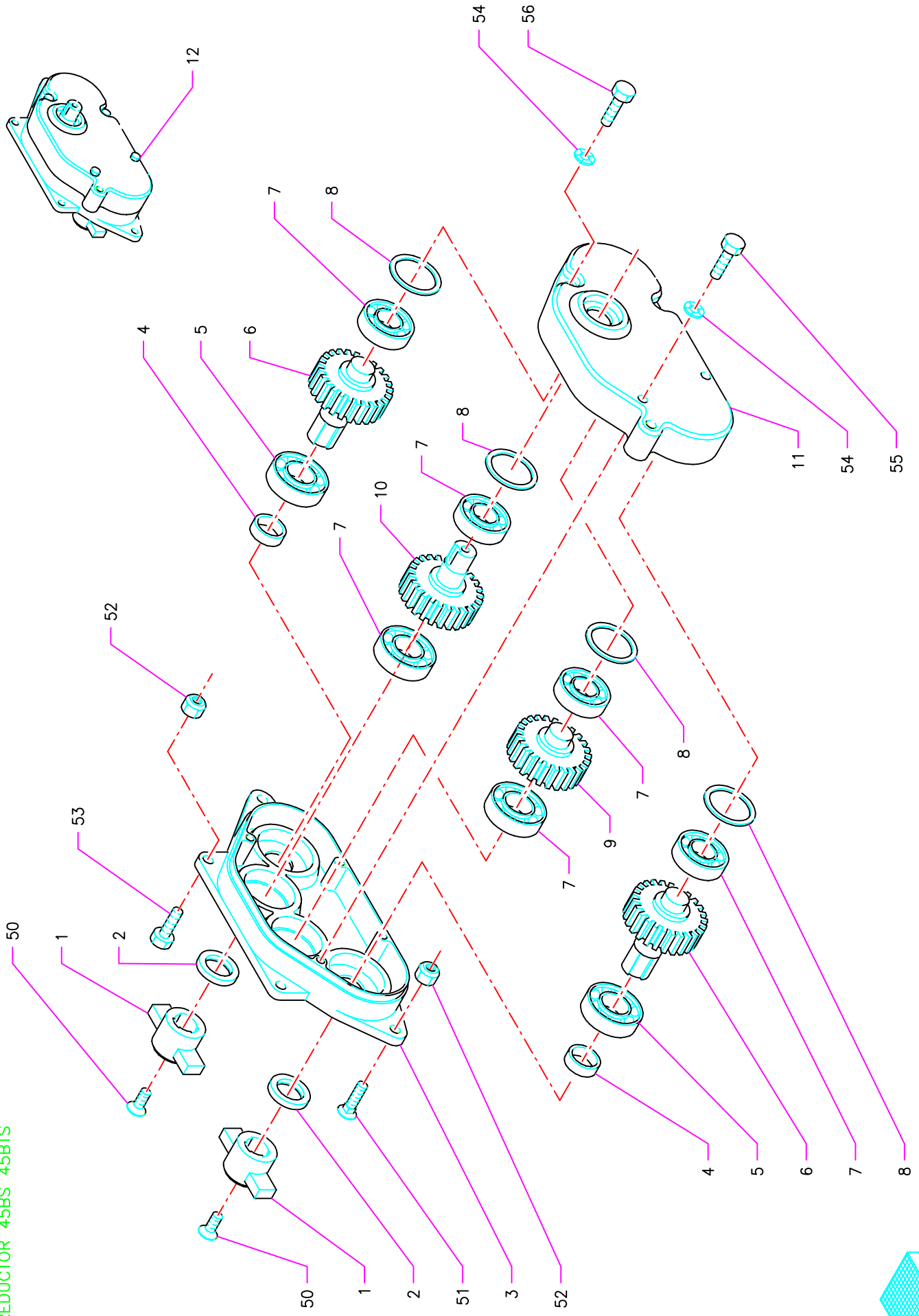
GRUPPO RIDUTTORE 45BS 45BTS
 REDUCTION GEAR ASSEMBLY 45B 45BTS
 GROUPE DU REDUCTEUR 45BS45BTS
 GETRIEBEGRUPPE 45BS 45BTS
 GRUPO REDUCTOR 45BS 45BTS



TAV.12 rev.01 GRUPPO RIDUTTORE 45BS-BTS

Pos.	Mod.	Codice	Q.tà	Denominazione	Denomination	Description	Benennung	Description
1		400731	2	ATTACCO	COUPLING	ATTAQUE	KUPPLUNG	ACLOPAMIENTO
2		407610	2	PARAOILIO	OIL SEAL	JOINT PAULSTRA	SIMMERING	ARO RASCADOR DE
3		203431	1	CASSA RIDUTTORE	REDUCTION GEAR BOX	BOITIER REDUCTEUR	GETRIEBEGEHAUSE	CAJA REDUCTOR
4		407986	2	DISTANZIALE	SPACER	ENTRETOISE	DISTANZHÜLSE	DISTANCIADOR
5		408432	2	CUSCINETTO	BEARING	ROULEMENT	LAGER	COJINETE
6		408151	2	RUOTA CONDOTTA	DRIVEN GEAR	ROUE MENE	GETGRIEBENES RAD	RUEDA DE CONDUCTA
7		408428	6	CUSCINETTO	BEARING	ROULEMENT	LAGER	COJINETE
8		409243	4	ANELLO	RING	ANNEAU	RING	ANILLO
9		408152	1	RUOTA FOLLE	IDLE WHEEL	ROUE FOLLE	LOSRAD	RUEDA LIBRE
10		202493	1	RUOTA MOTRICE	DRIVING GEAR	ROUE MOTRICE	TREIBENDES RAD	RUEDA MOTRIZ
11		400730	1	COPERCHIO RIDUTTORE	COVER	COUVERCLE	DECKEL	TAPA
12		203049	1	RIDUTTORE COMPLETO	REDUCTION GEAR ASS.	REDUCTEUR COMPLET	GETRIEBE KOMPLETT	REDUCTOR COMPLETO
50		-	-	VITE Ø 4,2x16 AUTOFIL. UNI 6954	SCREW	VIS	SCHRAUBE	TORNILLO
51		-	-	VITE M6x20 UNI 5732	SCREW	VIS	SCHRAUBE	TORNILLO
52		-	-	DADO M6 AUTOBL. UNI 7474	LOCK NUT	ECROU AUTOBLOQUANT	STOPMUTTER	TUERCA AUTOBLOCANTE
53		-	-	VITE M6x16 UNI 5739 A2	SCREW	VIS	SCHRAUBE	TORNILLO
54		-	-	RONDELLA M5 DIN 6798/A	LOCK WASHER	RONDELLE	ZAHNSCHEIBE	ARANDELA DENTADA
55		-	-	VITE M5x25 UNI 5739	SCREW	VIS	SCHRAUBE	TORNILLO
56		-	-	VITE M5x20 UNI 5739	SCREW	VIS	SCHRAUBE	TORNILLO

GRUPPO COMANDO TERGIPAVIMENTO B/BS
 SQUEEGE CONTROL ASSEMBLY B/BS
 COMMANDE DE SUCEUR B/BS
 SAUGFUSSBETAETIGUNG B/BS
 MANDO LIMPIAPAVIMENTOS B/BS

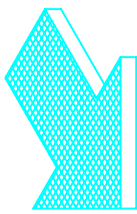
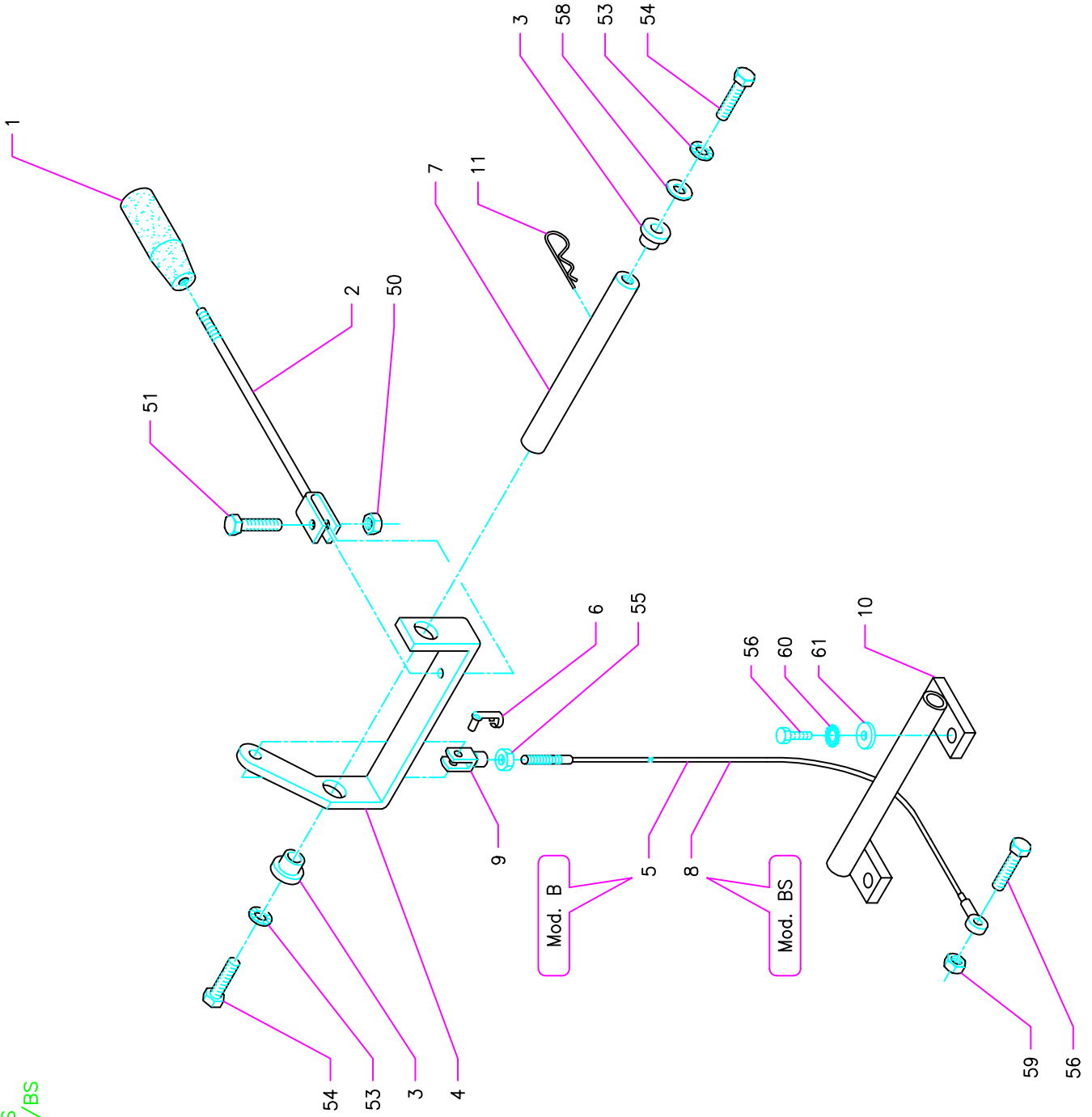

TAV.13 rev.01 GRUPPO COMANDO TERGIPAVIMENTO B-BS

Pos.	Mod.	Codice	Q.tà	Denominazione	Denomination	Description	Benennung	Description
1		410265	1	MANOPOLA	HANDLE	POGNEE	GRIFF	MANGO
2		206840	1	MANETTA TERGIPAVIMENTO	HANDLE	MENOTTES	HANDSCHELLE	MANETA
3		414726	2	BOCCOLA	BUSHING	DOUILLE	BUCHSE	CASQUILLO
4		203497	1	LEVA SOLLEVAMENTO	LEVER	LEVIER	HEBEL	PALANCA
5	B	415133	1	CAVO TERGIPAVIMENTO	CABLE	CABLE	KABEL	CABLE
6		410463	1	CLIPS PER FORCELLA	FORK PIN	AXE	BOLZEN	PERNO
7		203498	1	ALBERO COMANDO TERGIPAVIM.	SHAFT	ARBRE	WELLE	EJE
8	BS	415154	1	CAVO TERGIPAVIMENTO	CABLE	CABLE	KABEL	CABLE
9		410455	1	FORCELLA	FORK	FOURCHE	GABEL	HORQUILLA
10		203499	1	STAFFA TENDICAVO	BRACKET	ATTAQUE	BÜGEL	SOPORTE FIJADOR
11		409392	1	SPILLO Ø 2	PIN	CHEVILLE	STIFT	PASADOR
50		-	-	DADO M6 AUTOBL. UNI 7474	LOCK NUT	ECROU AUTOBLOQUANT	STOPMUTTER	TUERCA AUTOBLOCANTE
51		-	-	VITE M6X16 UNI 5739	SCREW	VIS	SCHRAUBE	TORNILLO
53		-	-	RONDELLA M6 DIN 6798/A	LOCK WASHER	RONDELLE	ZAHNSCHEIBE	ARANDELA DENTADA
54		-	-	VITE M6X20 UNI 5739	SCREW	VIS	SCHRAUBE	TORNILLO
55		-	-	DADO M6 UNI 5588	NUT	ECROU	MUTTER	TUERCA
56		-	-	VITE M5X16 UNI 5739	SCREW	VIS	SCHRAUBE	TORNILLO
58		-	-	RONDELLA M6 D.18 UNI 6593	WASHER	RONDELLE	SCHWEIBE	ARANDELA
59		-	-	DADO M5 UNI 5589	NUT	ECROU	MUTTER	TUERCA
60		-	-	ROSETTA M5 DIN 6798/A	LOCK WASHER	RONDELLE	ZAHNSCHEIBE	ARANDELA DENTADA
61		-	-	ROSETTA M5 D.15 UNI 6593	WASHER	RONDELLE	SCHWEIBE	ARANDELA

GRUPPO COMANDO TERGIPAVIMENTO – GRUPPO FRENO BT/BTS
 SQUEEGE CONTROL ASSEMBLY – BRAKE ASSEMBLY BT/BTS
 COMMANDE DE SUCEUR – GROUPE DE FREIN BT/BTS
 SAUGFUSSBETAETIGUNG – BREMSANLAGE BT/BTS
 MANDO LIMPIAPAVIMENTOS – GRUPO FRENO BT/BTS

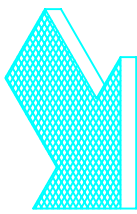
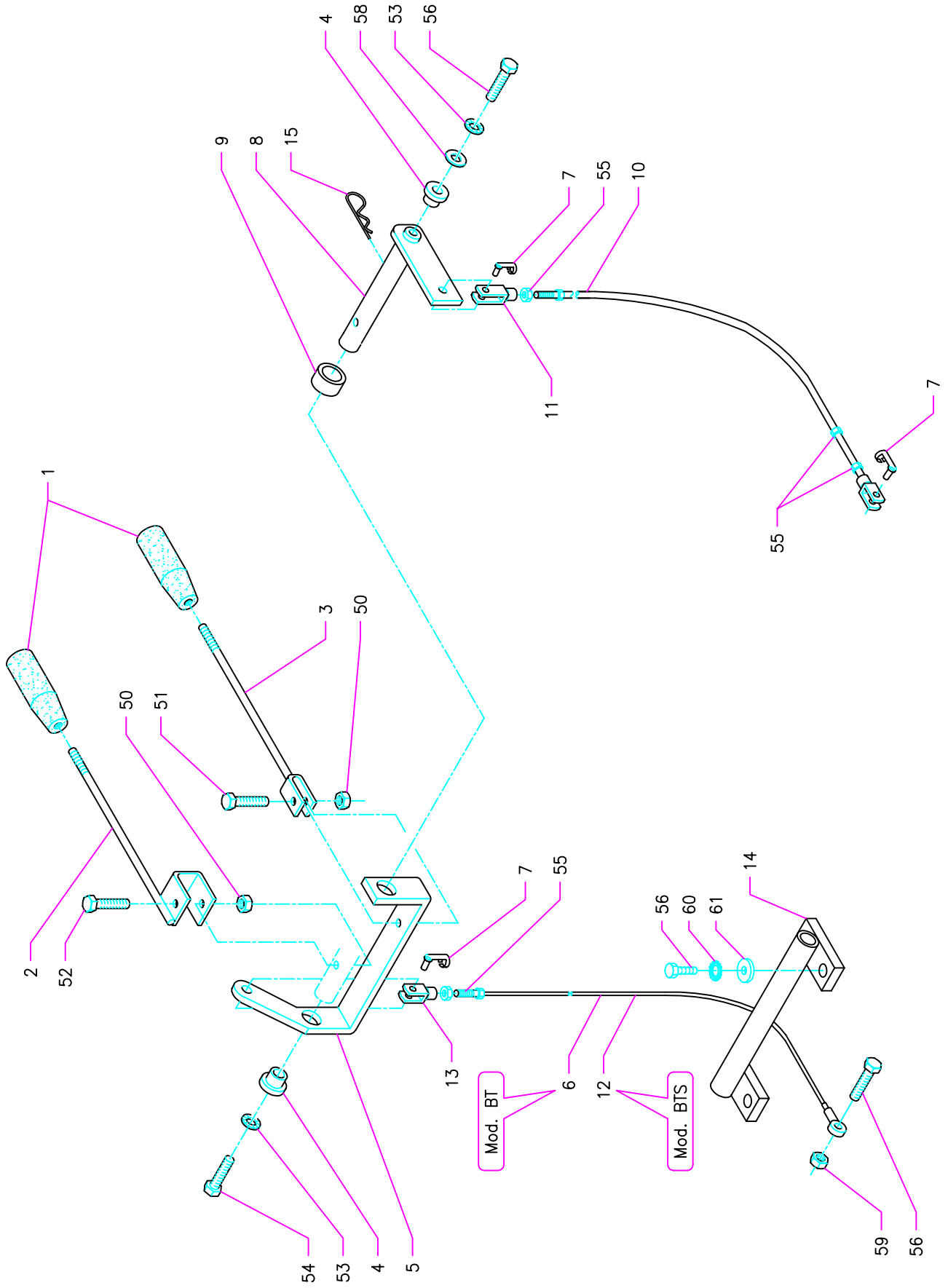

TAV.13A

rev.01

GRUPPO COMANDO TERGIPAVIMENTO – COMANDO FRENO BT-BTS

Pos.	Mod.	Codice	Q.tà	Denominazione	Denomination	Description	Benennung	Description
1		410265	2	MANOPOLA	HANDLE	POGNEE	GRIFF	MANGO
2		203506	1	MANETTA FRENO	HANDLE	MENOTTES	HANDSCHELLE	MANETA
3		206840	1	MANETTA TERGIPAVIMENTO	HANDLE	MENOTTES	HANDSCHELLE	MANETA
4		414726	2	BOCCOLA	BUSHING	DOUILLE	BUCHSE	CASQUILLO
5		203497	1	LEVA SOLLEVAMENTO	LEVER	LEVIER	HEBEL	PALANCA
6	BT	415133	1	CAVO TERGIPAVIMENTO	CABLE	CABLE	KABEL	CABLE
7		410463	3	CLIPS PER FORCELLA	FORK PIN	AXE	BOLZEN	PERNO
8		203505	1	ALBERO COMANDO FRENO	SHAFT	ARBRE	WELLE	EJE
9		202458	1	DISTANZIALE	SPACER	ENTRETOISE	ABSTANDSTUCK	SEPARADOR
10		415138	1	CAVO FRENO	CABLE	CABLE	KABEL	CABLE
11		410455	1	FORCELLA	FORK	FOURCHE	GABEL	HORQUILLA
12	BTS	415154	1	CAVO TERGIPAVIMENTO	CABLE	CABLE	KABEL	CABLE
13		410455	1	FORCELLA	FORK	FOURCHE	GABEL	HORQUILLA
14		203499	1	STAFFA TENDICAVO	BRACKET	ATTAQUE	BÜGEL	SOPORTE FIJADOR
15		409392	1	SPILLO Ø 2	PIN	CHEVILLE	STIFT	PASADOR
50		-	-	DADO M6 AUTOBL. UNI 7474	LOCK NUT	ECROU AUTOBLOQUANT	STOPMUTTER	TUERCA AUTOBLOCANTE
51		-	-	VITE M6X16 UNI 5739	SCREW	VIS	SCHRAUBE	TORNILLO
52		-	-	VITE M6X30 UNI 5739	SCREW	VIS	SCHRAUBE	TORNILLO
53		-	-	RONDELLA M6 DIN 6798/A	LOCK WASHER	RONDELLE	ZAHNSCHEIBE	ARANDELA DENTADA
54		-	-	VITE M6X20 UNI 5739	SCREW	VIS	SCHRAUBE	TORNILLO
55		-	-	DADO M6 UNI 5588	NUT	ECROU	MUTTER	TUERCA
56		-	-	VITE M6X20 UNI 5739	SCREW	VIS	SCHRAUBE	TORNILLO
58		-	-	RONDELLA M6 D.18 UNI 6593	WASHER	RONDELLE	SCHLEIBE	ARANDELA
59		-	-	DADO M5 UNI 5589	NUT	ECROU	MUTTER	TUERCA
60		-	-	ROSETTA M5 DIN 6798/A	LOCK WASHER	RONDELLE	ZAHNSCHEIBE	ARANDELA DENTADA
61		-	-	ROSETTA M5 D.15 UNI 6593	WASHER	RONDELLE	SCHLEIBE	ARANDELA

GRUPPO MOTORE ASPIRAZIONE B-BT / BS-BTS
 SUCTION MOTOR ASSEMBLY B-BT / BS-BTS
 GROUPE DE MOTEUR D'ASPIRATION B-BT / BS-BTS
 SAUGMOTORGRUPPE B-BT / BS-BTS
 GRUPE DE MOTOR DE ASPIRACION B-BT / BS-BTS

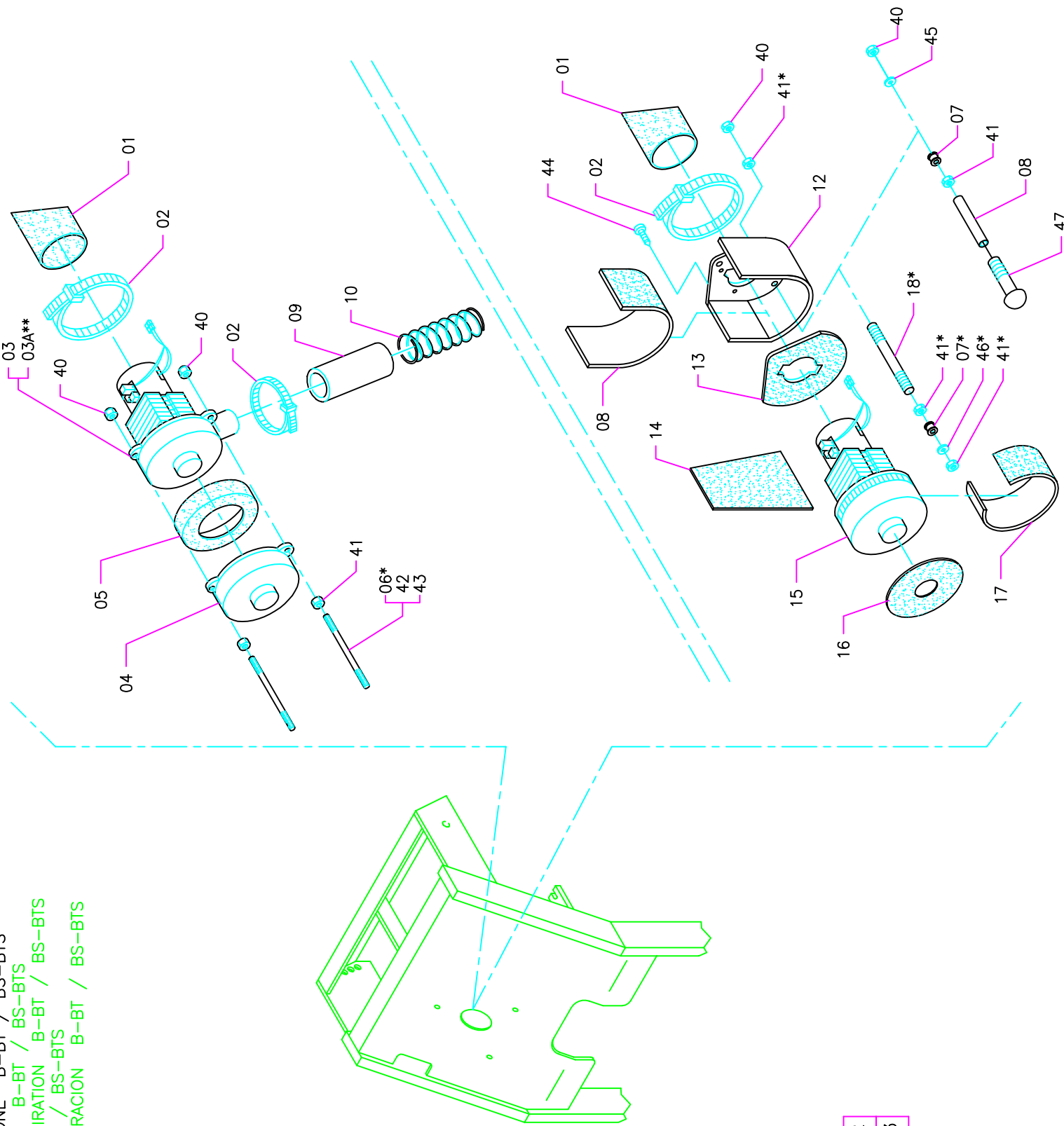

*	10/2002
**	06/2003

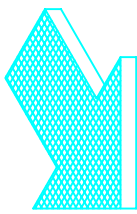

TAV.14 rev.02 GRUPPO MOTORE ASPIRAZIONE B-BT / BS-BTS

Pos.	Mod.	Codice	Q.tà	Denominazione	Denomination	Description	Benennung	Description
1	◆○	202243	1	TUBO FONOASSORBENTE	DEADENING HOSE	TUYAU ISOLANT PHONIQUE	SCHALLSCHLUCKER	TUBO FONOAASSORBENTE
2		410276	1	FASCETTA PLASTICA	CLAMP	COLLIER	BRIDE	ABRAZADERA
3		203214	1	MOTORE ASP. 24V H=1200 PREMON.	SUCTION MOTOR	MOTEUR D'ASPIRATION	SAUGMOTOR	MOTOR SUCCION
3A	♣	203217	1	MOTORE ASP. 36V 3 STADI	SUCTION MOTOR	MOTEUR D'ASPIRATION	SAUGMOTOR	MOTOR SUCCION
4	♣	414960	1	SUPPORTO	SUPPORT	SUPPORT	HALTERUNG	SOPORTE
5		405936	1	CUFFIA MOTORE ASPIRAZIONE	GASKET	JOINT	LAGERRING	ANILLO
6		415134	3	COLONNETTA	STUD BOLT	TIGE	GEWINDEBOLZEN	PRISIONERO
7	○	409810	3	PASSACAVO PER FORO	FAIRLEAD	PASSE-CABLE	KABELMUFFE	GUJACABLE
8	○	414686	3	DISTANZIALE	SPACER	ENTRETOISE	DISTANZHULSE	DISTANCIADOR
9		202241	1	TUBO FONOAASSORBENTE	DEADENING HOSE	TUYAU ISOLANT PHONIQUE	SCHALLSCHLUCKER	TUBO FONOAASSORBENTE
10		202485	1	MOLLA TRAZIONE PER TUBO	DEADENING HOSE	TUYAU ISOLANT PHONIQUE	SCHALLSCHLUCKER	TUBO FONOAASSORBENTE
11	○	414350	1	FONOAS. CARTER ASP.	DEADENING HOSE	TUYAU ISOLANT PHONIQUE	SCHALLSCHLUCKER	TUBO FONOAASSORBENTE
12	○	203523	1	CARTER ASPIRATORE	COVER	CARTER	ABDECKUNG	TAPA
13	○	414352	1	FONOAS. LATO MOTORE ASP.	DEADENING HOSE	TUYAU ISOLANT PHONIQUE	SCHALLSCHLUCKER	TUBO FONOAASSORBENTE
14	○	414351	1	TUBO FONOAASSORBENTE	DEADENING HOSE	TUYAU ISOLANT PHONIQUE	SCHALLSCHLUCKER	TUBO FONOAASSORBENTE
15	○	407503	1	MOTORE ASP. 36V 1600H 550W	SUCTION MOTOR	MOTEUR D'ASPIRATION	SAUGMOTOR	MOTOR SUCCION
16	○	405832	1	FONOAS. FONDO MOTORE ASP.	DEADENING HOSE	TUYAU ISOLANT PHONIQUE	SCHALLSCHLUCKER	TUBO FONOAASSORBENTE
17	○	405833	1	FONOAS. LAT. MOTORE ASP.	DEADENING HOSE	TUYAU ISOLANT PHONIQUE	SCHALLSCHLUCKER	TUBO FONOAASSORBENTE
18	○	206225	3	COLONNETTA	STUD BOLT	TIGE	GEWINDEBOLZEN	PRISIONERO
40		-	-	DADO M6 AUTOBL. UNI 7474	LOCK NUT	ECROU AUTOBLOQUANT	STOPMUTTER	TUERCA AUTOBLOCANTE
41		-	-	DADO M6 UNI 5588	NUT	ECROU	MUTTER	TUERCA
42	◆	-	-	VITE M6X80 UNI 5732 TTQST	SCREW	VIS	SCHRAUBE	TORNILLO
43	♣	-	-	VITE M6X120 UNI 5732 TTQST	SCREW	VIS	SCHRAUBE	TORNILLO
44		-	-	VITE Ø 4,8X13 AUTOFIL. UNI 6954	SCREW	VIS	SCHRAUBE	TORNILLO
45		-	-	ROSETTA M6 D.18 UNI 6593	WASHER	RONDELLE	SCHEIBE	ARANDELA
46		-	-	ROSETTA M6 UNI 6592	WASHER	RONDELLE	SCHEIBE	ARANDELA
47	○	-	-	VITE M6x90 UNI 5732 TTQST	SCREW	VIS	SCHRAUBE	TORNILLO

◆ = INDY - BASIC LINE

♣ = PROFY LINE

○ = KLINIK LINE